

GRADALL[®]

LOED[®] MATERIAL HANDLER

MODEL 534A

Service Manual

PART NO. 9020-5896

This manual describes the LOED Handler as originally designed and built by the LOED Corporation. The LOED Handler product line was purchased October 15, 1982 by The Warner & Swasey Co., a subsidiary of The Bendix Corporation. Descriptions and specifications shown herein are subject to change without notice.

IMPORTANT

READ AND UNDERSTAND THIS MANUAL BEFORE STARTING, OPERATING OR PERFORMING MAINTENANCE PROCEDURES ON THIS MACHINE.

KEEP THESE MANUAL IN CAB

THE
GRADALL[®]
COMPANY

Gradall is a registered trademark for hydraulic excavators built by The Gradall Co.

406 MILL AVENUE S.W.
NEW PHILADELPHIA, OHIO 44663
(216) 339-2211

CONTENTS

Service/replacement parts	3
Capacity	4
Nomenclature	5
Retraction chain replacement	6
Extension chain replacement	8
Boom hose replacement	10
Shift control adjustment	11
Brake adjustment	12
Tire and rim repair	13
Parking brake repair	18
Power master cylinder repair	20
Planetary hub repair	24
Hydraulic pressure adjustment	29
Hydraulic cylinder repair	30
Valve repair	32
Pump and motor troubleshooting	44
Pump repair	45
Rear motor repair	55
Front motor repair	74
Bolt torque chart	84
Hydraulic fitting torque chart	85
Electrical schematic	86
Hydraulic schematic	89
Hydraulic component location	93
Parts section - contents	95

IMPORTANT SAFETY NOTICE

Safe operation depends on reliable equipment and proper operating procedures. Performing the checks and services described in this manual will help to keep your Gradall Handler in reliable condition and use of the recommended operating procedures can help you avoid accidents. Because some procedures may be new to even the experienced operator we recommend that this manual be read, understood and followed by all who operate the unit.

Danger, Warning and Caution notes in this manual will help you avoid injury and damage to the equipment. These notes are not intended to cover all eventualities; it would be impossible to anticipate and evaluate all possible applications and methods of operation for this equipment.

Any procedure not specifically recommended by The Gradall Division must be thoroughly evaluated from the standpoint of safety before it is placed in practice. If you aren't sure, contact your Gradall Distributor before operating.

Do not modify this machine without written permission from the Gradall Division.

NOTICE

The Gradall Division retains all proprietary rights to the information contained in this manual.

The Company also reserves the right to change specifications without notice.

SERVICE

Your LOED Handler distributor is properly equipped to service your LOED Handler. Repairs should be made by trained and qualified service personnel only.



CAUTION: Do not attempt to repair your machine unless you are trained and qualified to do so.

Modifications must not be made unless prior approval has been obtained from LOED Corporation. Your distributor has the necessary forms to request authorization for specific modifications.



CAUTION: Do not modify your machine without prior approval of LOED Corporation. The safety and reliability of your machine may be affected by improper modification.

REPLACEMENT PARTS

Replacement parts can be ordered from your nearest LOED Handler distributor.

Always furnish the machine model and serial number as well as a complete description of the part and the part number. This enables the distributor to quickly and accurately fill your order.

NOTE: For a safer more dependable machine, use only factory approved parts.

MODEL 534

6,000# Capacity

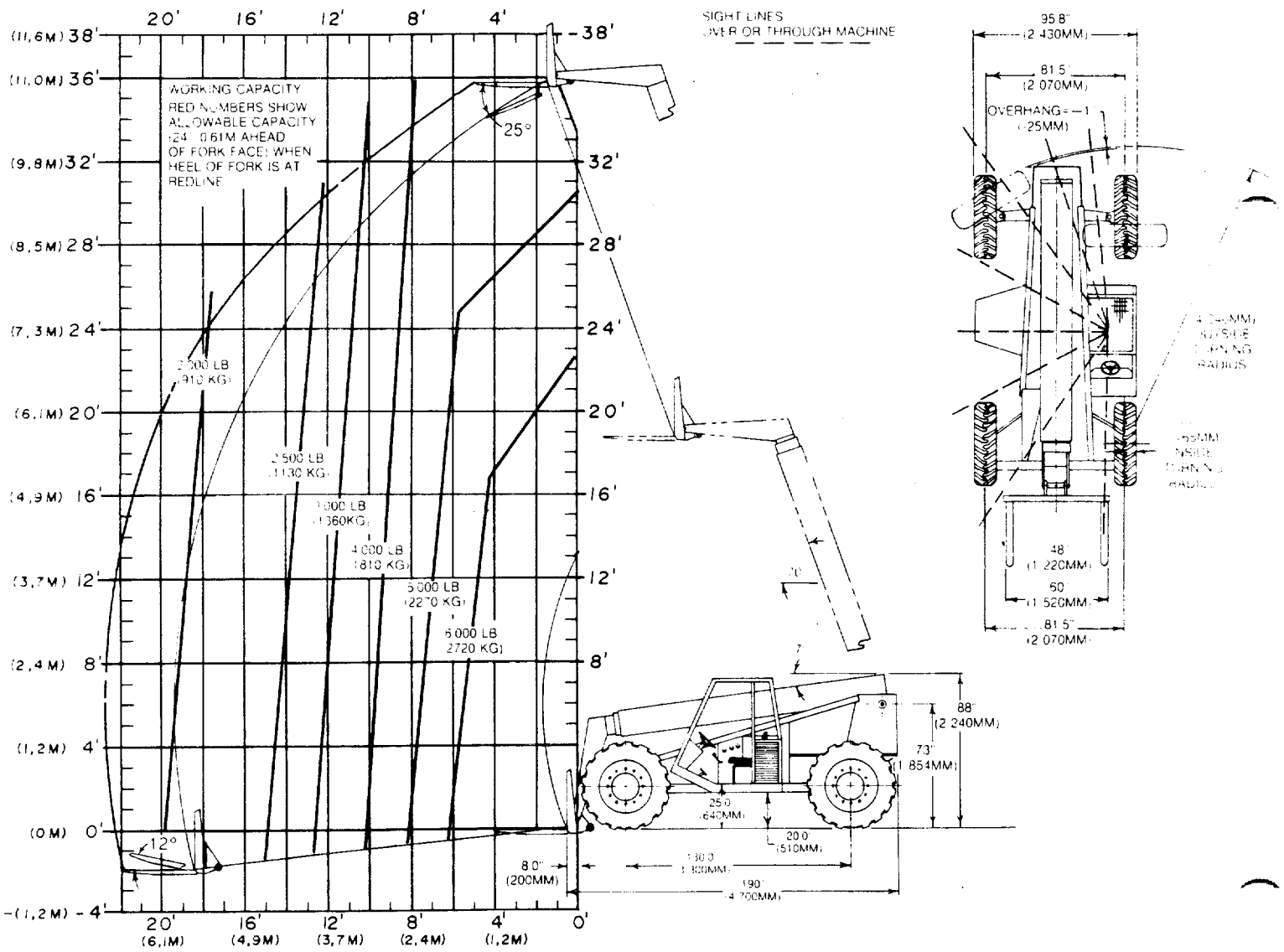

FIGURE 1

NOMENCLATURE

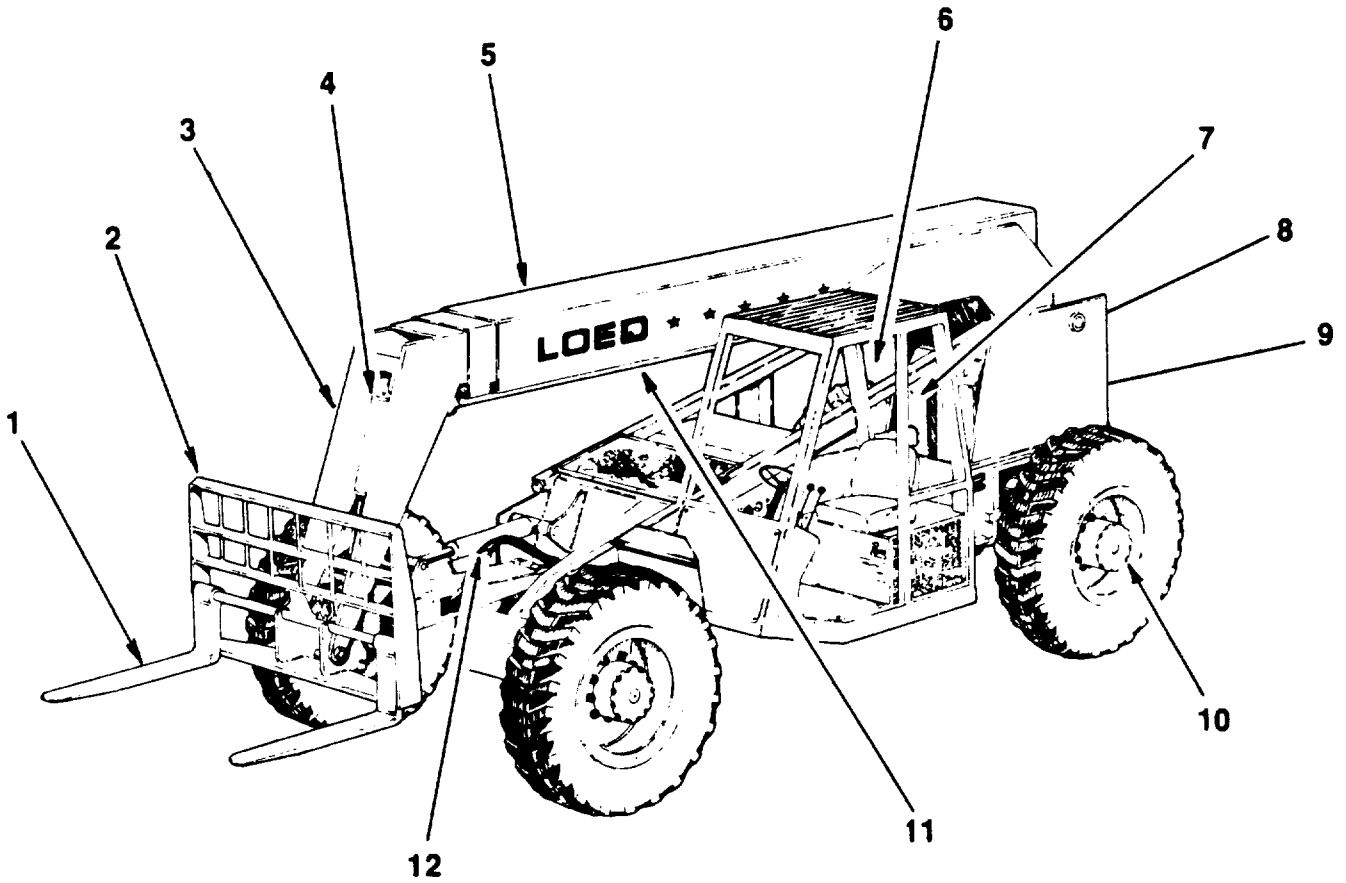

FIGURE 2

- | | |
|-----------------------|--------------------------|
| 1. FORKS | 7. COMPENSATING CYLINDER |
| 2. FORK FRAME | 8. HYDRAULIC RESERVOIR |
| 3. BOOM HEAD | 9. FUEL TANK |
| 4. TILT CYLINDER | 10. PLANETARY HUB |
| 5. THREE SECTION BOOM | 11. CROWD CYLINDER |
| 6. LIFT CYLINDER | 12. LEVEL CYLINDER |

RETRACTION CHAIN REPLACEMENT

DISSASSEMBLY

1. Retract boom completely.
2. Remove rear boom cover.
3. Remove extension (large) chain adjusting nut and jam nut.
4. Remove hose retainer nuts and jam nuts. Disconnect hoses.
5. Remove bolts holding hose guide pan to front of strongback.
6. Remove strongback.
7. Unpin retraction (small) chain from chain ears at back of third
8. section.
9. Unpin retraction chain from section one ears (access hole in bottom of section).
Pull chain out back of boom.

REASSEMBLY

Note: Replace chain ends whenever chain is replaced.

1. Use fish wire to pull new chain from back of boom to ears in bottom of section one.
2. Lay chain over sheave and pin to back of section three.
3. Reinstall strongback. Use LOCTITE 242 (blue-medium strength)
4. on all bolts and torque to specification.
5. Bolt hoseguide pan to strongback.
Reconnect extension chain. With crowd cylinder fully retracted, tighten extension chain until there is no slack in retracting chain. Install jam nut.
6. Reconnect hoses and hose retainers.
7. Reinstall rear boom cover.

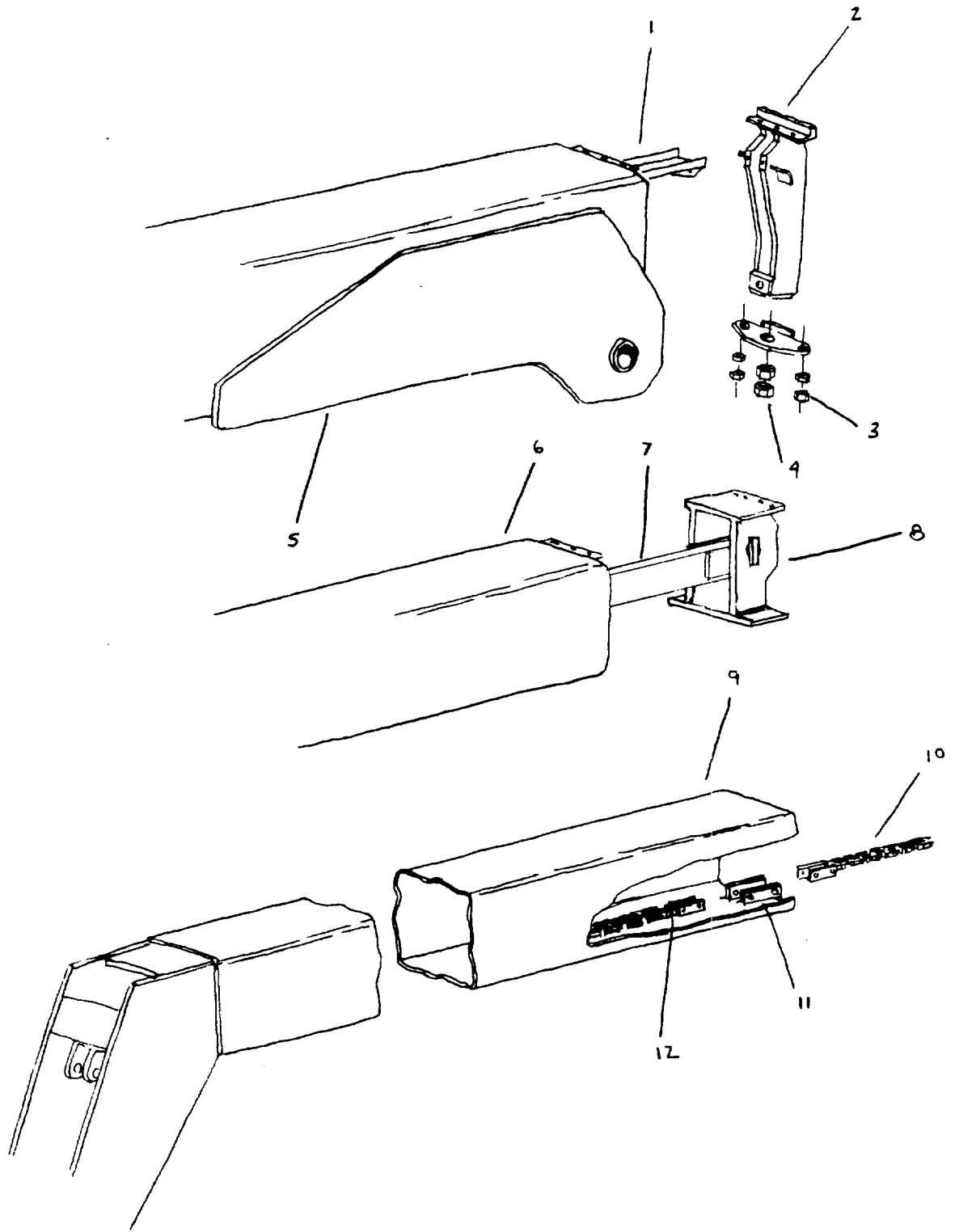

FIGURE 3

- | | |
|-------------------------|------------------------------|
| 1. Guide Pan | 7. Take-up Beam |
| 2. Strongback | 8. Take-up Beam Bracket |
| 3. Hose Retainer Nuts | 9. Section Three |
| 4. Extension Chain Nuts | 10. Retraction Chain |
| 5. Section One | 11. Section Three Chain Ears |
| 6. Section Two | 12. Extension Chain |

DISSASSEMBLY

1. Retract boom completely.
2. Remove rear boom cover.
3. Remove extension (large) chain adjusting and jam nuts.
4. Remove hose retainer and jam nuts. Disconnect hoses.
5. Remove bolts holding hose guide pan to front of strongback.
6. Remove strongback.
7. Unpin retraction (small) chain from chain ears at back of third section. Allow chain to lie on bottom of 1st section.
8. Unbolt take-up beam bracket from back of section two. Pull beam and hose guide pan out back of boom.
9. Unpin extension chain from ears at back of section three.

REASSEMBLY

Note: Replace chain ends whenever chain is replaced

1. Pin extension chain to ears at back of section three.
2. Lay chain and hoses in hose guide pan.
3. Carefully slide take-up beam and guide pan into boom allowing chain and hoses to roll over sheaves at front of beam.
4. Bolt take-up beam bracket into back of section two.

Note: Use LOCTITE 242 (blue-medium strength) on all bolts and torque to specification.

5. Pin retraction chain to ears on back of section three.
6. Reinstall strongback.
7. Bolt hose guide pan to strongback.
8. Reconnect extension chain. With crowd cylinder fully retracted, tighten extension chain until there is no slack in retraction chain.
9. Reconnect hoses and hose retainers.
10. Reinstall rear boom cover.

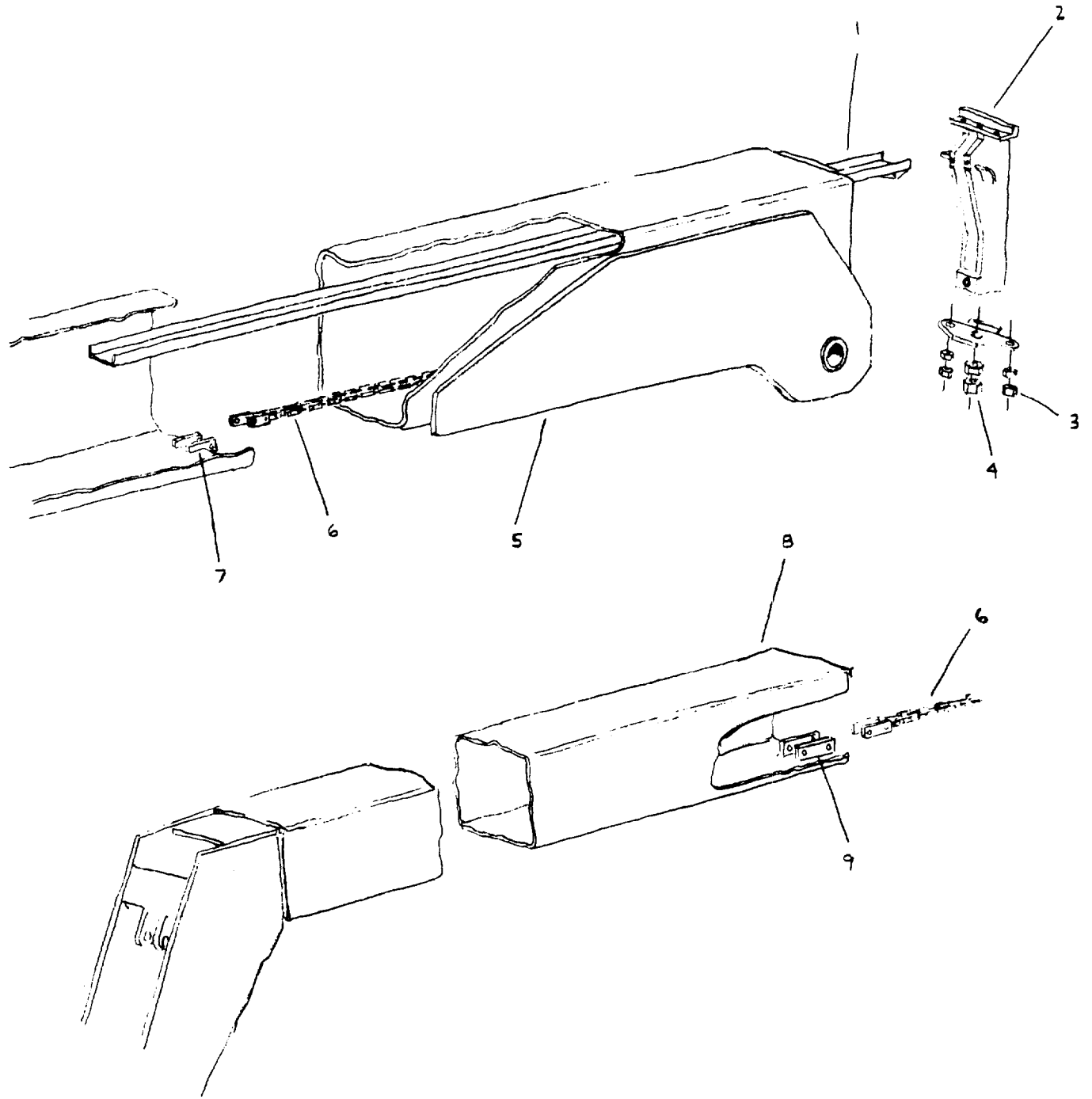

FIGURE 4

- | | |
|-------------------------|--------------------------------------|
| 1. Guide Pan | 6. Retraction Chain |
| 2. Strongback | 7. Retraction Chain Ears - Section 1 |
| 3. Hose Retainer Nuts | 8. Section Three |
| 4. Extension Chain Nuts | 9. Retraction Chain Ears - Section 3 |
| 5. Section One | |

BOOM HOSE REPLACEMENT

IF HOSE IS INTACT

1. Remove rear boom cover.
2. Disconnect hose retainer and remove tensioning spring.
3. Connect new hose to old hose with short length of steel wire.
4. Disconnect old hose at back of section three. Carefully pull new hose along guide pan and around reel while pulling old hose out back of boom.
5. Connect new hose to tube line at rear of section three.
6. Reassemble hose retainer and reinstall. Connect hose.
7. Replace rear boom cover.

IF HOSE IS BROKEN

Follow disassembly procedure outlined in “Extension Chain Replacement” through step 8. Replace hose and reassemble.

SHIFT CONTROL LINKAGE ADJUSTMENT

1. Put shift control in 1st gear.
2. Adjust valve linkage (A) so micro switch (B) is actuated with spool pulled down to stop.
3. Adjust linkage (C) so movement of lever from 1-2 and 3-4 moves spool from full down to full up.
4. Adjust linkage (D) so spool moves from full back to full forward as lever is moved from 2-3.
5. Repeat 1 thru 4 as necessary to get smooth shifting action.

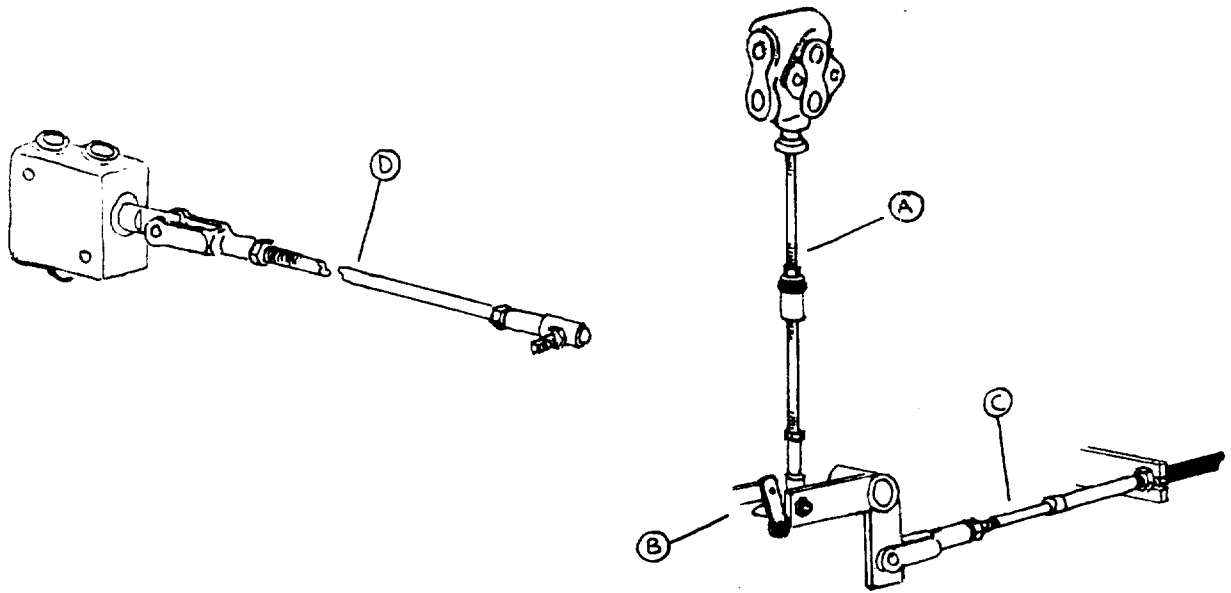

FIGURE 5

BRAKE ADJUSTMENT

SERVICE BRAKE

Note: Prior to any brake adjustment the forward-reverse linkage must be adjusted as follows:

1. With the forward-reverse lever in neutral, adjust linkage rod "A" so that "B" to "B1" and "C" to "C1" are of equal length, with the forward-reverse valve spool in its neutral position (linkage rod "D" may have to be adjusted to reach alignment).
2. With the forward-reverse lever in forward, depress brake pedal until all slop is taken up in the brake linkage. At that point the spool in the forward-reverse valve should be 1/8" out of the neutral position. If not, adjust brake linkage compression spring "E" to reach that point.

PARKING BRAKE

1. The spring-apply/hydraulic release brake requires no adjustment.
2. On machines with mechanical brake calipers, adjust both sides so the pads nearly touch the disc when the lever is in the off position.

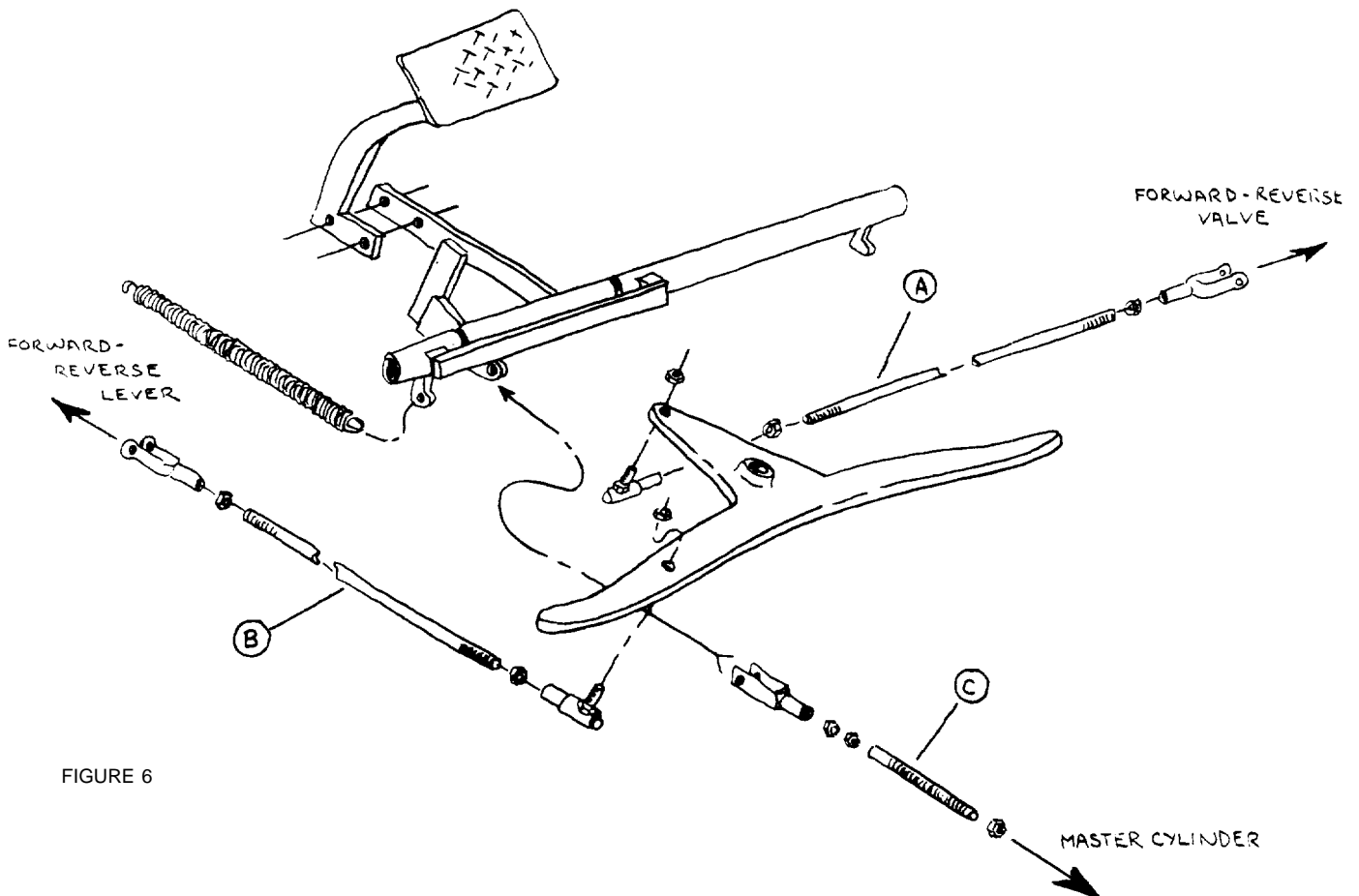

FIGURE 6

IMPORTANT

For safety's sake, always remove the valve core and exhaust all air from a single tire and from both tires of a dual assembly prior to removing any rim components, or any wheel components, such as nuts and rim clamps.

Check the valve stem by running a piece of wire through the stem to make sure it is not plugged

GENERAL:

- Do not mount or demount tires without proper training. Follow all procedures and safety instructions. Wall charts containing mounting and demounting instructions for all Goodyear on-highway rims are available through your Goodyear rim supplier. Ask for "ON-HIGHWAY RIM MOUNTING AND DEMOUNTING CHART SET NO. TR71-2042". This set contains five charts covering all Goodyear on-highway rims.
- "MULTIPIECE RIM/WHEEL MATCHING CHARTS" are available through Motor Wheel Corporation and the United States Department of Transportation (DOT), Washington, D.C.

DEMOUNTING:

- Always exhaust all air from a single tire and from both tires of a dual assembly prior to removing any rim components or any wheel components such as nuts and rim clamps.
- Make sure to remove valve core to exhaust all air from the tire. Remove both cores from a dual assembly.
- Check the valve stem by running a piece of wire through the stem to make sure it is not plugged.

INSPECTION:

- Clean rims and repaint to stop detrimental effects of corrosion and facilitate checking and tire mounting. Be very careful to clean all dirt and rust from the lock ring and gutter. This is important to secure the lock ring in its proper position. A filter on the air inflation equipment to remove the moisture from the air line helps prevent corrosion. The filter should be checked periodically to see that it is working properly.
- Check rim components periodically for cracks. Replace all cracked, badly worn, damaged and severely rusted components with new parts of same size and type. When in doubt replace.
- Do not, under any circumstances, attempt to rework, weld, heat, or braze any rim components that are cracked, broken, or damaged. Replace with new parts or parts that are not cracked, broken, or damaged and which are of the same size and type.
- Make sure correct parts are being assembled. Check DOT chart, your distributor or the manufacturer if you have any doubts.
- Don't be careless or take chances. If you are not sure about the proper mating of rim and wheel parts, consult a rim and wheel expert. This may be the tire man who is servicing your fleet, the rim and wheel distributor in your area, or the Motor Wheel sales engineer.

- Mixing parts of one type rim with those of another is potentially dangerous. Always check DOT chart or manufacturer for approval.
- Don't reinflate a tire that has been run flat without first inspecting the tire, tube, flap, rim and wheel assembly. Double check the side ring, flange, bead seat, lock ring and "O" ring for damage and make sure that they are secure in the gutter before inflation.

MOUNTING AND INFLATION:

- Don't try to seat rings or other components by hammering while tire is inflated or partially inflated.
- Double check to make sure all components are properly seated prior to inflation. Inflate in a safety cage or use safety chains during inflation.
- Don't inflate tire before all components are properly in place. Place in safety cage and inflate to approx. 10 psi, recheck components for proper assembly. If assembly is not proper, deflate and correct. Never hammer on an inflated or partially inflated tire rim assembly. If assembly is proper at approx. 10 psi, continue to inflate to fully seat the tire beads. Then completely deflate the tire to prevent localized over stretching of tube. Reinflate to recommended operating pressure.
- Never sit on or stand in front of a tire and rim assembly that is being inflated. Use a clip on chuck and make sure inflation hose is long enough to permit the person inflating the tire to stand to the side of the tire, not in front or in back of the tire assembly.
- Follow tire and rim manufacturer's recommended mounting, demounting inflating and deflating procedures for tires and rims.
- Don't hammer on rims or components with steel hammers. Use rubber, lead, plastic or brass faced mallets if it is necessary to tap components together.

SERVICING TIRE AND RIM ON VEHICLE:

- Don't try to drive an assembled or partially assembled tire and rim over a cast spoke wheel by hammering. Stop - deflate and examine to determine the reason for

the improper fit. Look for distortion or to components that are not properly locked or seated.

- Block the tire and wheel on the opposite side of the vehicle before you place the jack in position.
- Regardless of how hard or firm the ground appears, put hardwood blocks under the jack. Always crib up vehicle with blocks just in case the jack should slip.

OPERATION:

Don't use undersized rims. Use recommended rim for tire. Check Goodyear/Motor Wheel catalogs for proper tire/rim matching.

- Don't overload or over-inflate tire/rim assemblies. Check your rim manufacturer if special operating conditions are required.
- Never run a vehicle on one tire of a dual assembly. The carrying capacity of the single tire and rim is dangerously exceeded and operating a vehicle in this manner can result in damage to the rim and tire.

ADDITIONAL NOTES APPLYING TO EARTHMOVER RIMS:

- Use caution when removing heavy earth-mover rim components. Use mechanical aids. This will help protect you from injury.
- Demounting tools apply pressure to rim flanges to unseat tire beads. Keep your fingers clear. Always stand to one side when you apply hydraulic pressure (if the tool slips off, it can fly with enough force to cause severe bodily injury or death).
- When using a cable or chain sling, stand clear; it might snap and lash out.
- Never attempt to weld on an inflated tire/rim assembly or on a rim assembly with a deflated tire.
- Wall charts containing mounting and demounting instructions for all Goodyear off-highway rims are available through your Goodyear rim supplier. Ask for "OFF-HIGHWAY RIM MOUNTING AND DEMOUNTING CHART SET NO EM73-2154". This set contains four charts covering all Goodyear off-highway rims.

TWO-PIECE RIMS

Correct

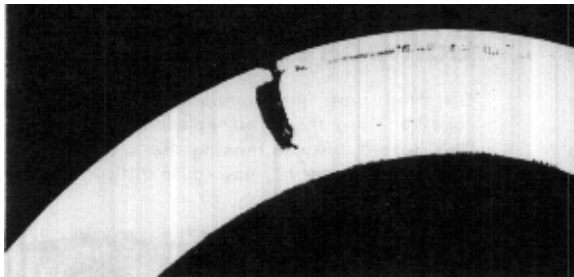

FIGURE 7
The components in a correctly assembled and locked two-piece rim fit snugly.

Incorrect

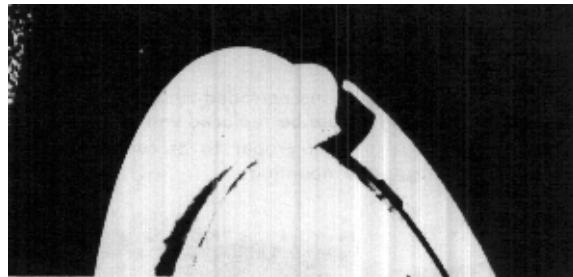

FIGURE 9
An incorrectly assembled two-piece rim could have a large gap in side ring. Components are not firmly locked in place. **DO NOT INFLATE TIRE AND RIM ASSEMBLY UNTIL COMPONENTS ARE PROPERLY SEATED AND LOCKED.**

THREE-PIECE RIMS

Correct

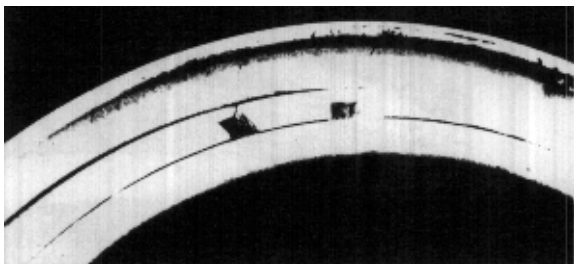

FIGURE 8
A three piece rim that is correctly assembled has firmly-fitted components: lock ring gap is small with lock ring completely embedded in its cavity.

Incorrect

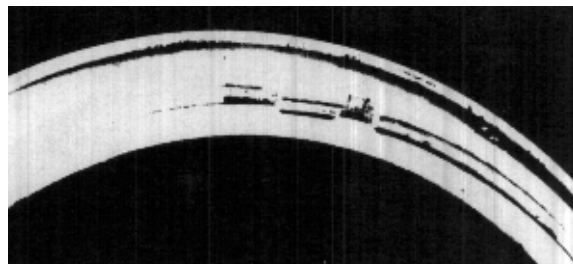

FIGURE 10
An incorrectly assembled three-piece rim. Lock ring is not seated. **DO NOT INFLATE UNTIL LOCK RING IS PROPERLY SEATED AND LOCKED.**

KW, KB, KWX TYPE RIMS

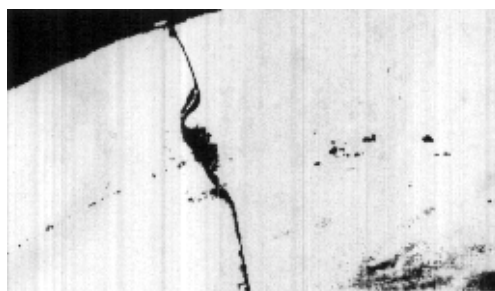
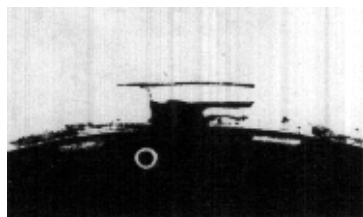

FIGURE 11

KW, KB, and KWX type rims have unique configurations that deserve special mention. Make sure your assembly pattern matches that shown in photographs of correctly assembled rims. **DO NOT INFLATE UNTIL ALL RIM COMPONENTS ARE PROPERLY LOCKED AND SEATED.**

Correct



Side ring is seated in gutter hook.

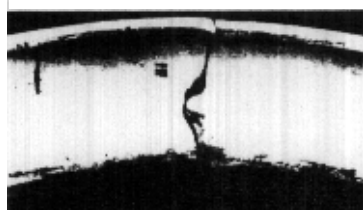

Rim ends match; rim locking device is securely locked.

FIGURE 12

Incorrect

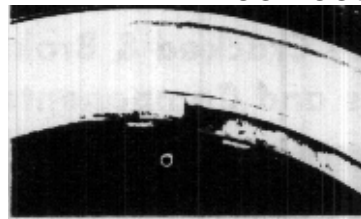

Side ring is not seated in gutter hook. Check for incomplete assembly or worn rim. **Do not inflate tire.**



Rim base is not locked. One raised end of rim end means incorrect assembly or bent rim. **Do not inflate tire.**

FIGURE 13

Replace Worn, Rusted & Corroded Rim Parts

Badly worn, rusted and corroded rims and components are dangerous and should be replaced with new parts.

Such hazards prevent proper fit of components, and can cause difficult tire mounting.

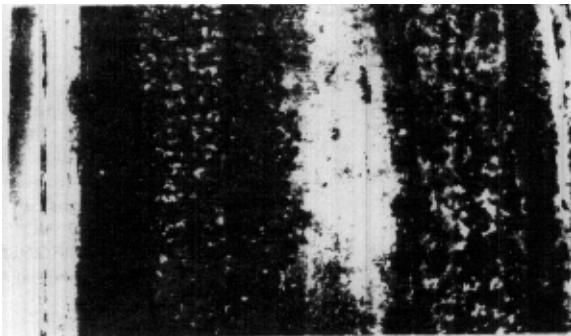
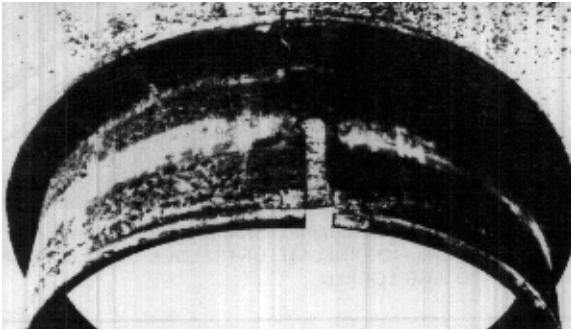
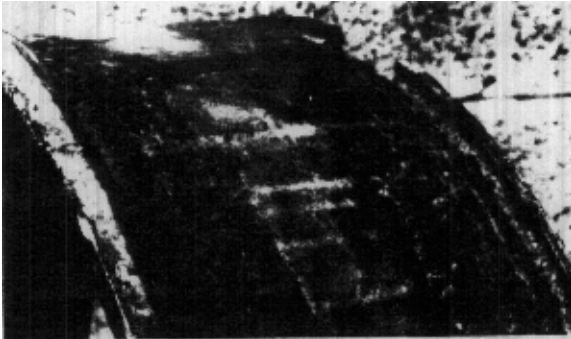

FIGURE 14

Replace Cracked & Broken Rims and Components

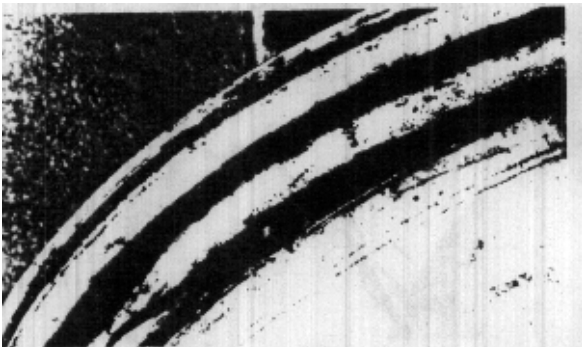

FIGURE 15

Fatigue-cracked or broken rims and components must be replaced. Periodically inspect all rims and components for signs of fatigue cracks or breakage.

Replace Distorted Rims & Components

Distorted rims and components will not properly lock together. They should be replaced.

This hazard, besides making the tire/rim assembly unsafe through improper fit, may cause difficult tire mounting.

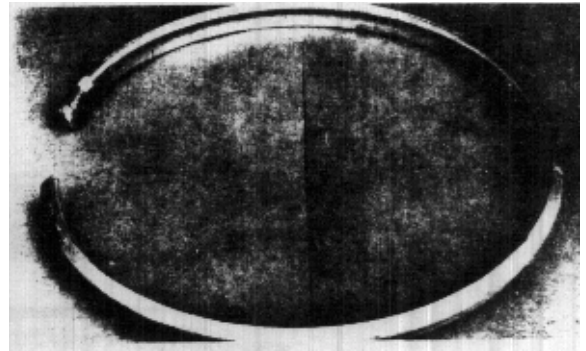
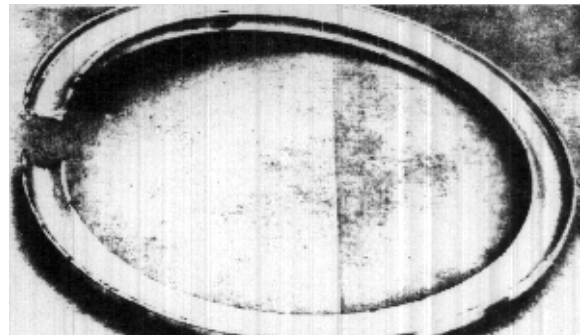
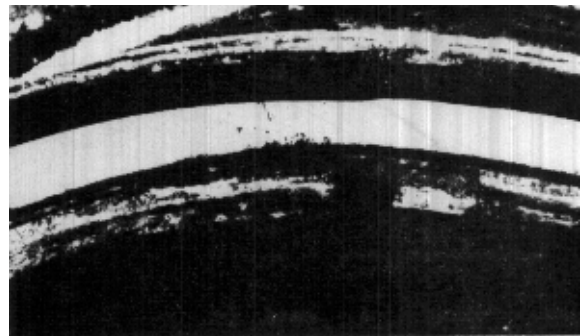
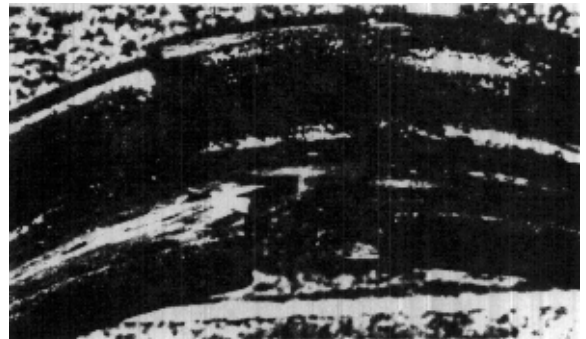

FIGURE 16

WARNING!

MISMATCHED RIM PARTS ARE DANGEROUS AND COULD CAUSE SEVERE INJURY

Most highway rims look alike, but all vary somewhat in certain design features. It is these differences between rims of different types that makes "part-mixing" a hazardous business. A close, proper fit between rim parts is essential to long tire life as well as to operating safety. Very often, side-rings, flanges and lock-rings of different types appear to be properly seated, but actually wide gaps

are present, frequently difficult to see. The rim cross-sections below show correct, safe matchings of rim parts as well as mismatched rings and bases which almost always create an unsafe operating condition. The pictures contained herein are intended only to depict some examples of incorrect procedures. They are not intended to show all incorrect and dangerous methods.

NOTE: Contact Motor Wheel Corp. for list of components that are designed to interchange with components of other manufacturers. Department of Transportation (DOT) charts show rim interchangeability.

CORRECT

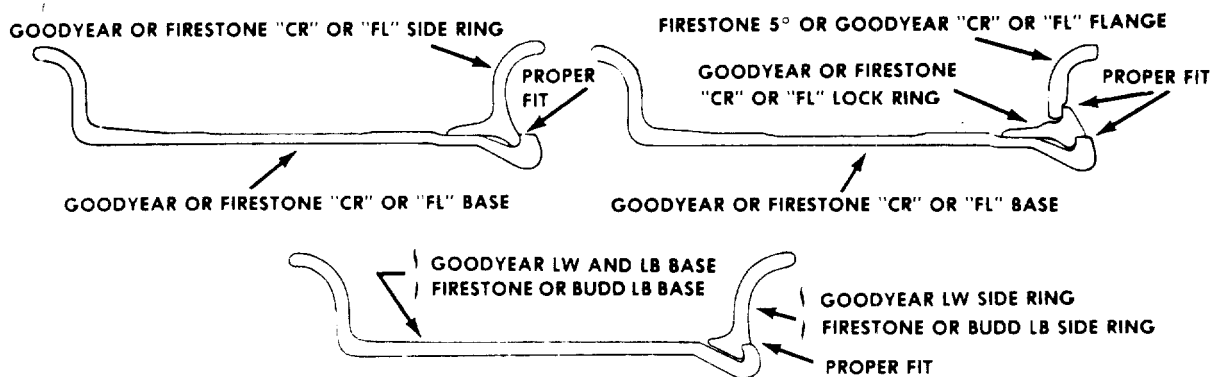

FIGURE 17

Goodyear "CR" and "FL" bases and components interchangeable with Firestone "CR" and "FL". Goodyear "LB" bases and components interchangeable with Firestone and Budd "LB".

INCORRECT

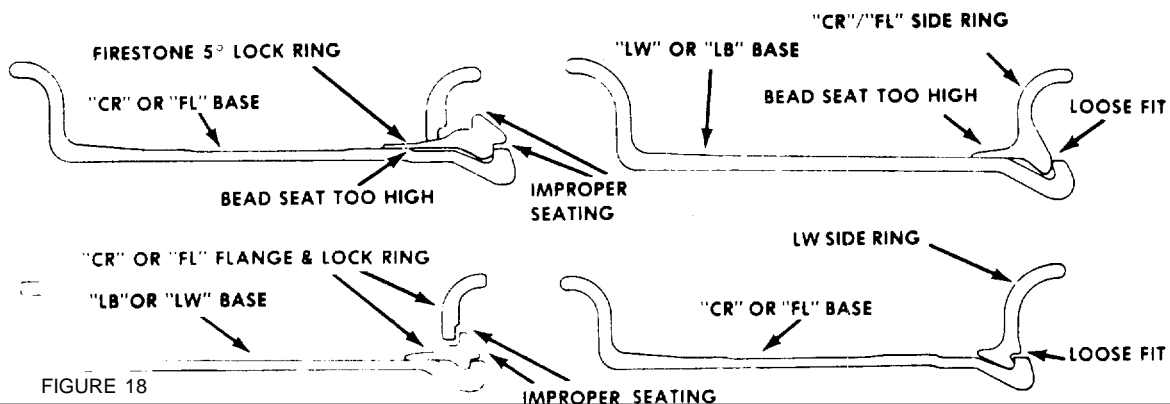

FIGURE 18

IMPROPER RIM SELECTION CAN CAUSE THESE TIRE AND TUBE OPERATING PROBLEMS

- TIRE SLIPPAGE
- TUBE PINCHING
- VALVE STEM TEAR OUTS
- PLY SEPARATION
- EXCESSIVE FLEXING
- OVERHEATING
- SIDEWALL FAILURES
- BLOWOUTS

PARKING BRAKE

FUNCTION

The Parking Brake is spring loaded to apply the brake. Hydraulic pressure is used to release or hold "off" the brake.

DISSASSEMBLY PROCEDURE

1. Loosen 2 bolts (22) alternately.
2. Separate power plate (18) assembly from the remainder of the brake.
3. Remove O-ring (5).
4. Remove rotating disc (10) from splined shaft (7), remove springs (12) and stationary disc (11) from pins (8).
5. Repeat until all rotating discs (10), stationary disc (11) and springs (12) are removed.
6. Remove primary disc (9).
7. Remove pins (8).
8. Remove springs (6) from counter bores.
9. Further disassembly of the seal (1), snap ring (2), bearing (3), and shaft (7), from the housing (4) is not recommended, and should not be attempted unless necessary for the replacement of specific parts.
10. Remove seal (1). The seal will be damaged during removal and must be replaced.
11. Remove retaining ring (2).
12. Remove shaft (7) and bearing (3) by lightly tapping the shaft with a plastic mallet.
13. Remove shaft from bearing by supporting the inner race of the bearing and pressing the shaft out of the race.
14. Remove the piston (13) from the power plate (18) by introducing low pressure air - 15 psi - into the hydraulic inlet. Make sure piston is directed away from the operator.
15. Remove O-rings (15,17) and teflon back-up rings (14,16) from the O. D. and I. D. ring grooves. Removal of the teflon back-up rings (14,16) may cause damage to the teflon rings and should not be attempted unless necessary.
16. Remove snap ring (20).
17. Remove bearing (21) by tapping lightly with a plastic mallet.

ASSEMBLY PROCEDURE

Use the reverse of disassembly with the following note and additions:

1. Worn O-rings and damaged or worn teflon back-up rings must be replaced prior to reassembly.
2. Cylinder of the power plate, piston and O-rings must be clean prior to assembly, and pre-lubed with system hydraulic fluid.
3. Assemble piston (13) into power plate (18) using a shop press, being careful not to damage the O-rings or the teflon back-up rings. Visually align the center of the cut-outs in the piston (13) with the torque pin (8) holes in the power plate (18).
4. Rotating discs must be clean and dry. There should be no pressure of oil on any lining material or mating surfaces of the stationary discs.
5. Alternately tighten bolts (22) and torque them to 75-85 lb. ft.

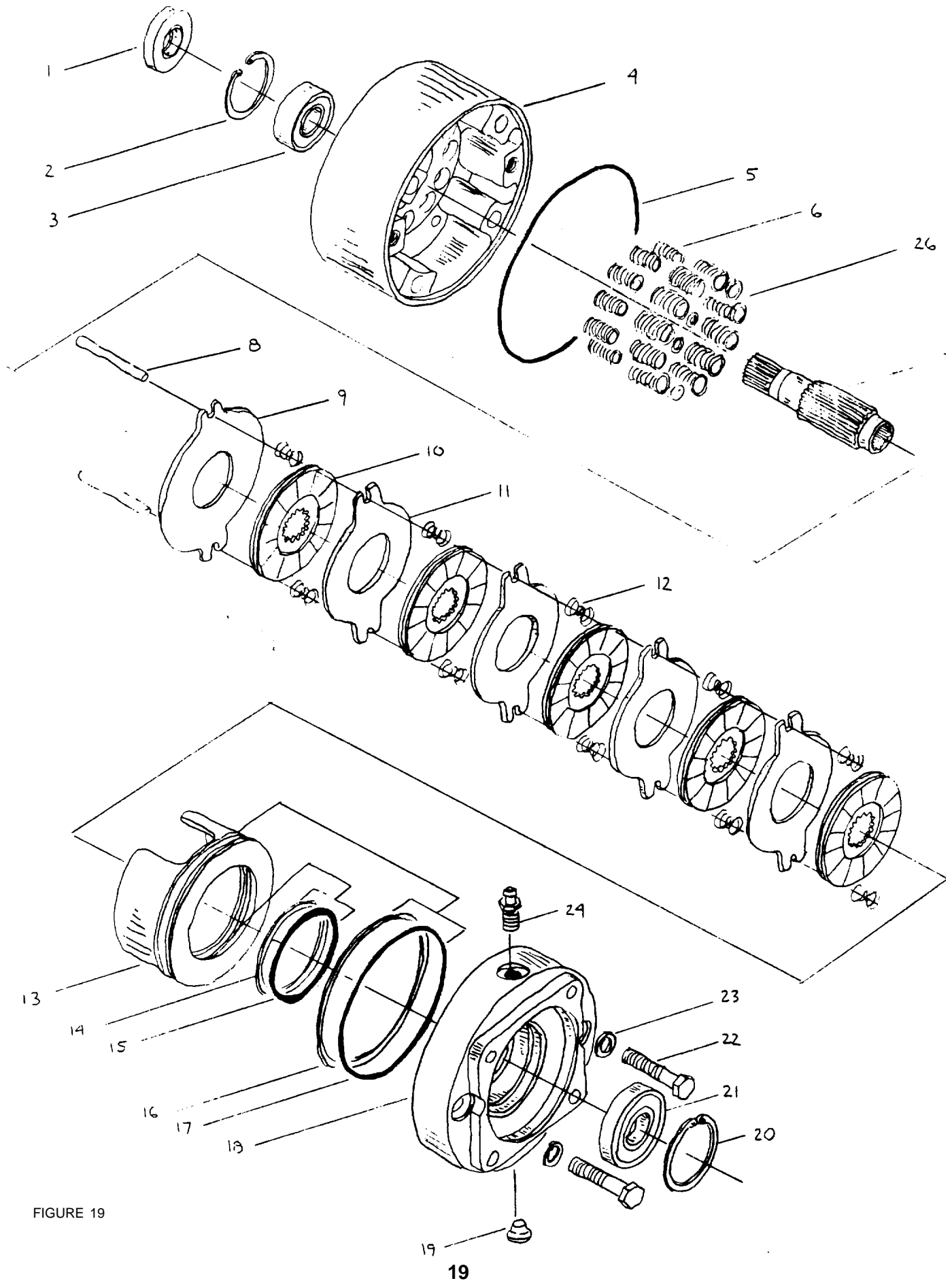

FIGURE 19

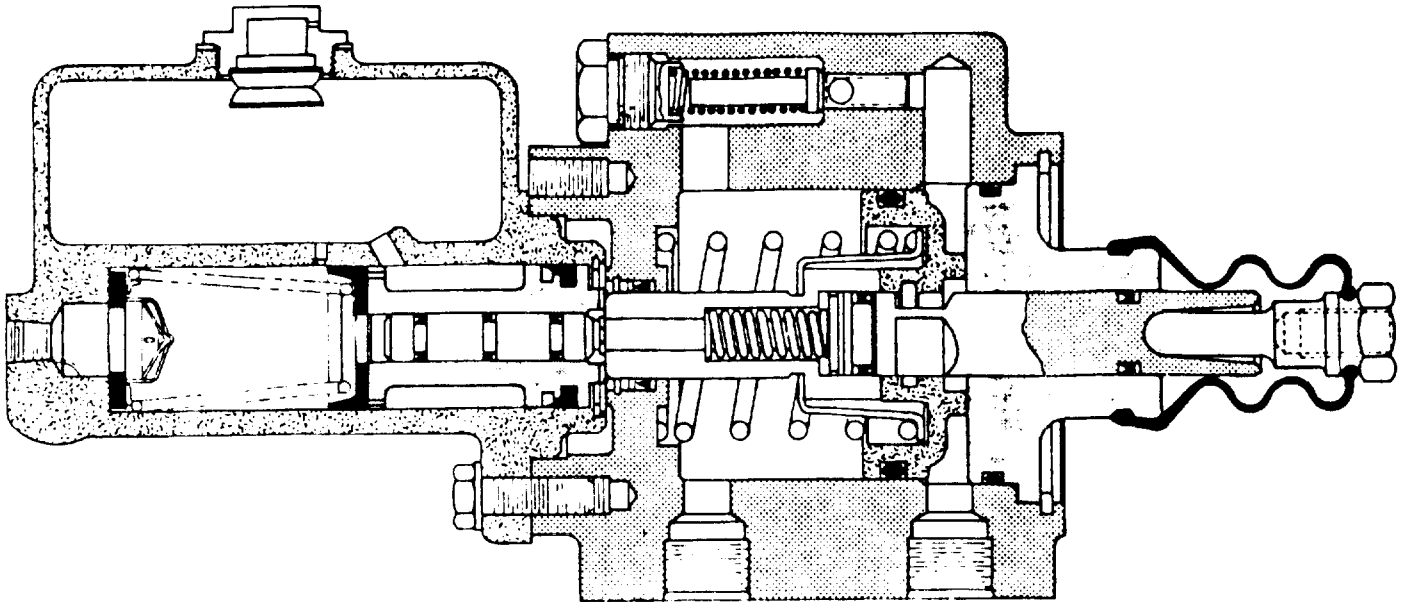

FIGURE 20

1.0 REMOVING BRAKE VALVE FROM VEHICLE AND SEPARATING CYLINDER RESERVOIR SECTION FROM POWER ASSIST SECTION. Refer to Figures 20 & 21.

1.1 Remove Brake Valve from vehicle by disconnecting necessary fluid lines, disconnecting push rod, and removing mounting bolts. Drain fluid from assembly.

1.2 Separate Cylinder Reservoir Section from Power Assist Section by removing three cap screws and three lock-washers.

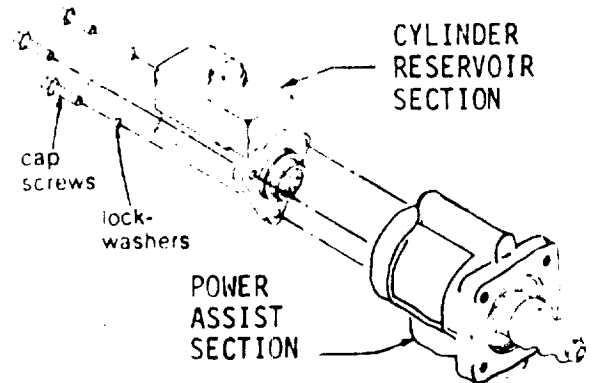

FIGURE 21

CYLINDER RESERVOIR SECTION

- 2.0 DISASSEMBLY OF CYLINDER RESERVOIR SECTION. Refer to Figures 1 & 3.
- 2.1 Drain fluid from unit before disassembling.
- 2.2 Remove retainer ring (item 1) from housing (item 14). CAUTION: Retainer ring is under tension of spring (item 11).
- 2.3 Remove assembly (item 17) from cylinder bore.
- 2.4 Remove cup (item 9), retainer (item 10), spring (item 11), check valve (item 12), and seat (item 13) from housing.
- 2.5 Remove filler cap (item 16) and gasket (item 15) from housing.

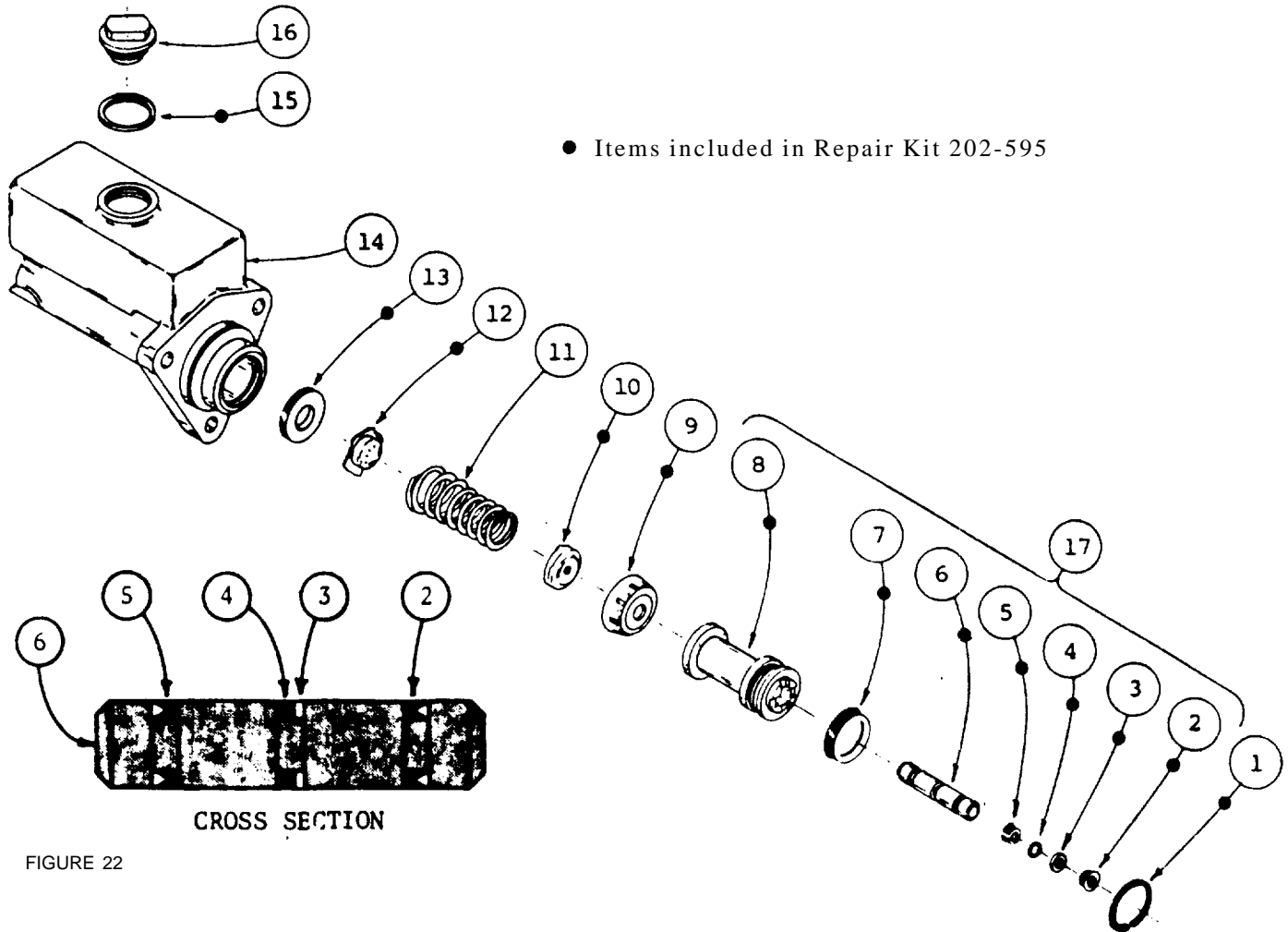
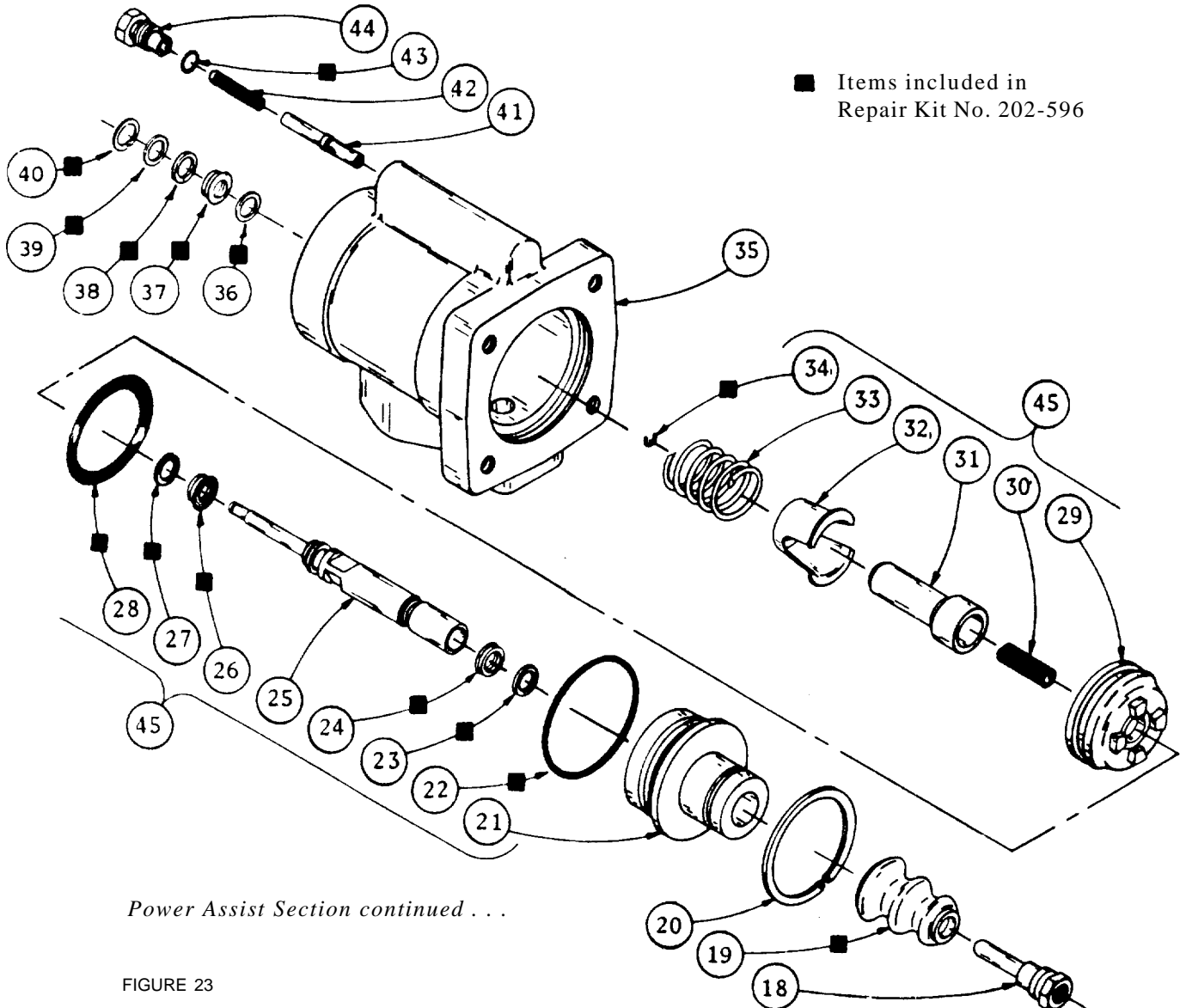

FIGURE 22

- 3.0 ASSEMBLY OF CYLINDER RESERVOIR SECTION. Use only brake fluid in Cylinder Reservoir Section. Use Repair Kit No. 02-400-058. Refer to Figures 20 & 22.
- 3.1 Clean all parts thoroughly before assembling.
- 3.3 Install seat (item 13) and check valve (item 12) in bore of housing. Attach retainer (item 10) to small end of spring (item 11). Install assembly items 10 & 11 into housing bore with large end of spring over check valve (item 12).
- 3.4 Lubricate cup (item 9) with type fluid used in system and install over retainer (item 10). Note direction of cup.
- 3.5 Lubricate v-cup seals (items 2 & 5), o-ring (item 4) and back-up ring (item 3). Then install on piston (item 6). Note order of washer and o-ring and direction of seals.
- 3.6 Install piston (item 6) in piston (item 8).
- 3.7 Lubricate cup (item 7) with type fluid used in system and install on piston (item 8). Note direction of cup.
- 3.8 Install assembly (item 17) in housing bore. Note direction of cup (item 7).
- 3.9 Install retainer ring (item 1) on housing.
- 3.10 Install gasket (item 15) and filler cap (item 16) on housing.

POWER ASSIST SECTION

- 4.0 DISASSEMBLY OF POWER ASSIST SECTION. Refer to Figures 20 & 23.
- 4.1 Drain fluid from unit before disassembling.
- 4.2 Remove push rod (item 18) and boot (item 19) from Power Assist Section.
- 4.3 Remove retaining ring (item 20). CAUTION: Retaining ring is under tension of spring (item 33).
- 4.4 Remove internal parts assembly (item 45) from housing.
- 4.5 Remove spring (item 33) and retainer (item 32) from internal parts assembly.
- 4.6 Remove end plug (item 21) from piston (item 25). Remove o’ring (item 22) from end plug.
- 4.7 plug.
- 4.8 Remove retainer ring (item 34) from piston (item 25).
Remove piston (item 31) from piston (item 25). Remove spring (item 30) from piston (item 25).
- 4.9 Remove v-cup seals (items 24 & 26) and back-up rings (items 23 & 27) from piston (item 25).
- 4.10 Remove piston (item 29) from piston (item 25), then remove o’ring (item 28) from piston (item 29).
- 4.11 Remove retaining ring (item 40) from housing. Remove washer (item 39), back-up ring (item 38), cup seal (item 37) and washer (item 36).
- 4.12 Remove o’ring or copper ring (item 43) from plug (item 44). NOTE: if an o’ring is found on plug replace with an o’ring, if a copper ring is found on plug replace with a copper ring.
- 4.13 Remove spring (item 42) and valve stem (item 41).



Power Assist Section continued . . .

FIGURE 23

- 5.0 ASSEMBLY OF POWER ASSIST SECTION. *Use only hydraulic oil in Power Assist Section.*
Use Repair Kit No. 02-400-059. Refer to Figures 20 & 23.
- 5.1 Clean all parts thoroughly before assembling.
- 5.2 Install valve stem (item 41) and spring (item 42) in housing.
- 5.3 Install o'ring or copper ring (item 43) on plug (item 44). NOTE: If an o'ring was found on plug replace with an o'ring, if a copper ring was found on plug replace with a copper ring.
- 5.4 Lubricate cup seal (item 37) with type fluid used in system. Install these parts in housing (item 35) in this order: steel washer (item 36), cup seal (item 37), teflon back-up ring (item 38), brass washer (item 39) and retaining ring (item 40). Note direction of seal.
- 5.5 Lubricate o'ring (item 28) with type fluid used in system and install on piston (item 29).
- 5.6 Install piston (item 29) on piston (item 25) between the two v-cup seal slots. Note direction of piston (item 29).
- 5.7 Lubricate back-up rings (items 23 & 427) and v-cup seals (items 24 & 26) with type fluid used in system and install on piston (item 25). Note direction of seals.
- 5.8 Install spring (item 30) on piston (item 25).
- 5.9 Install piston (item 31) over spring (item 30) and piston (item 25).
- 5.10 Install retaining ring (item 34) on piston (item 25).
- 5.11 Lubricate o'ring (item 22) with type fluid used in system and install on end plug (item 21).
- 5.12 Install end plug assembly (items 21 & 22) on piston (item 25).
- 5.13 Install retainer (item 32) over piston (item 31) and install spring (item 33) over retainer (item 32).
- 5.14 Install entire internal parts assembly (item 45) into housing bore. Use a twisting motion when inserting end of piston (item 25) through cup seal (item 37).
- 5.15 Install retaining ring (item 20) in housing (item 35).
- 5.16 Install boot (item 19) on end plug (item 21) and push rod (item 18) into boot,
-
- 6.0 CONNECTING CYLINDER RESERVOIR SECTION TO POWER ASSIST SECTION AND MOUNTING BRAKE VALVE ON VEHICLE. Refer to Figures 20 & 21.
- 6.1 Attach cylinder Reservoir Section to Power Assist Section with three cap screws and three lockwashers.
- 6.2 Install unit on vehicle. Connect push rod. Connect fluid lines. Bleed system of air. Tighten fittings if leaks should occur. Make several applications to be sure Brake Valve is working properly.

ASSEMBLY PROCEDURE FOR MAJOR ASSEMBLY

1. Start with hub-spindle sub-assembly (1) with large open end up.
2. Assemble internal gear (2) onto the spindle of hub-spindle sub-assembly (1).
3. Place thrust washer (15) onto the spindle pilot of hub-spindle sub-assembly (1).
4. Place thrust bearing (16) onto spindle pilot of hub-spindle sub-assembly (1).
5. Place thrust washer (15) onto spindle pilot of hub-spindle sub-assembly (1).
6. Drop spacer washer (7) into spindle of hub-spindle sub-assembly (1).
7. Place spring (8) into spindle of hub-spindle sub-assembly (1).
8. Place spacer washer (7) into spindle of hub-spindle sub-assembly (1).
9. Secure retaining ring (9) into groove in spindle of hub-spindle sub-assembly (1).
10. Secure retaining ring (10) in groove on input shaft (11).
11. Place long splined end of input shaft (11) into spindle of hub-spindle hub-assembly (1).
12. Slide thrust spacer (12) onto input shaft (11).
13. Put “O” ring (5) in hub counterbore of hub-spindle.
14. Place carrier sub-assembly (3) on a flat surface with large gears up. Find marked (punch marked) teeth on the large gears. Rotate until the marks are in a straight-up position. (See Figure).
15. Place ring gear (4) over large gears of carrier sub-assembly (3).
16. Holding ring gear (4) in mesh with large gears, pick-up carrier sub-assembly (3) until marked hold is located over one of the counterbored holes in hub of hub-spindle sub-assembly (1). Carrier sub-assembly (3) must rotate freely.
17. Put input gear (13) over input shaft (11) and meshing with large gears of carrier sub-assembly. Be sure that input gear (13) relief is as shown. (See Figure).
18. Put “O” ring (5) into cover counterbore of cover sub-assembly (6). Hold “O” ring in place with petroleum jelly or grease.
19. Place thrust washer (15) into carrier counterbore of carrier sub-assembly (3).
20. Place thrust bearing (16) into carrier counterbore of carrier sub-assembly (3).
21. Place thrust washer (15) into carrier counterbore of carrier sub-assembly (3).
22. Place cover sub-assembly (6) onto ring gear (4) with oil check plug in cover sub-assembly (6) located 90° from oil fill plug in hub-assembly sub-assembly (1).

23. Secure cover sub-assembly (6) and ring gear (4) in place with bolts. Use four shoulder bolts (18) for counterbored holes in hub of hub-spindle sub-assembly (1) and use bolts (17) for remaining holes. Tighten bolts to 47 ft. lbs. maximum.
24. Place coupling (19) into spindle of hub-spindle sub-assembly (1) and meshing with input shaft (11). On W3C be sure retaining ring (20) is in internal groove of coupling (19) and retaining ring (21) is located in external groove of coupling (19).

ASSEMBLY PROCEDURE OF HUB-SPINDLE SUB-ASSEMBLY

1. Press bearing cups (races) (1C) and (1C) and (1E) into hub (1G).
2. Set hub (1G) on large end. (Studs and disc are optional)
 - 2A. If required, press studs (1N) into hub (1G) flange.
 - 2B. If required, mount disc (1M) into hub (1G) rigs, and secure in place with lockwasher (1L) and bolts (1K).
3. Place bearing cone (1D) into bearing cup (race) (1C).
4. Preys seal (1B) into hub (1G).
5. Place spindle (1A) into bearing cone (1D). This is a loose fit and should not be pressed.
6. Invert the partial assembly of hub-spindle (1A), (1B), (1C), (1D), (1E), and (1G). Do not let spindle (1A) slip from hub (1G). Place spindle (1A) down.
7. Slide bearing cone (1F) onto the spindle (1A) against bearing cup (1E). This is NOT a press fit.
8. Place spacer (1H) on spindle (1A).
9. Place retaining ring (1I) on spindle (1A) groove. Be sure ring is completely in the groove.
10. Screw pipe plug (1J) into hub (1G) outside diameter.
11. The above step completes the sub-spindle sub-assembly (1) and the hub (1G) should turn freely with respect to the spindle (1A). The seal will cause a small amount of drag.

ASSEMBLY PROCEDURE FOR CARRIER SUB-ASSEMBLY

1. Set carrier (3A) on edge so that six small holes and two center holes are in a horizontal plane.
2. Lay two thrust washer (3B) on a flat surface with the tang facing up. Apply petroleum jelly or grease to this surface of both thrust washer (3B).

3. Place thrust washers (3B) inside carrier (3A) with greased side against carrier (3A) and the tang should be in cut away section of carrier (3A). Thrust washers (3B) are flat against the surface on both sides of carrier (3A).
4. Apply petroleum jelly or grease to bore of one cluster gear (3F). Place two sets of needle roller bearings (3C) into cluster gear (3F) bore with spacer (3D) between them. (See Figure).
5. Place cluster gear (3F) into carrier (3A) and between the two thrust washers (3B). (Be sure that large side of cluster gear (3F) is on same side as pin hole thru carrier (3A) wall).
6. Place planet shaft (3E) horizontally thru carrier (3A) wall, thrust washer (3B), needle rollers bearings (3C), thrust washer (3B) on opposite side, and carrier (3A) wall. NOTE: The hole in planet shaft (3E) must line-up with pin hole in carrier (3A) wall. The chamfered side of planet shaft (3F) hole should line-up with carrier (3A) wall pin hole.
7. Place roll pin (3G) in vertical hole in carrier (3A) wall and drive into hole until flush with surface of carrier (3A). (This will keep planet shaft (3E) from turning).
8. Repeat these steps for remaining two cluster gears (3F) to complete carrier sub-assembly.

ASSEMBLY OF COVER SUB-ASSEMBLY (SEE FIGURE FOR COVER SUB-ASSEMBLY)

1. Place "O" ring (6F) into cover cap (6B).
2. Place "O" ring (6G) over cover cap (6B).
3. Screw pipe plug (6H) into cover (6A).
4. Put cover cap (6B) into cover (6A) with clearance hole around the pipe plug (6H).
5. Place disconnect cap (6D) over the cover cap (6B) again with the clearance cover the pipe plug (6H).
6. Assemble (6D) with (four) bolts (6C) into the cover (6A). Two bolts hold cover cap (6B) and two bolts hold disconnect cap (6D).
7. Push disconnect rod (6E) into cover cap (6B).

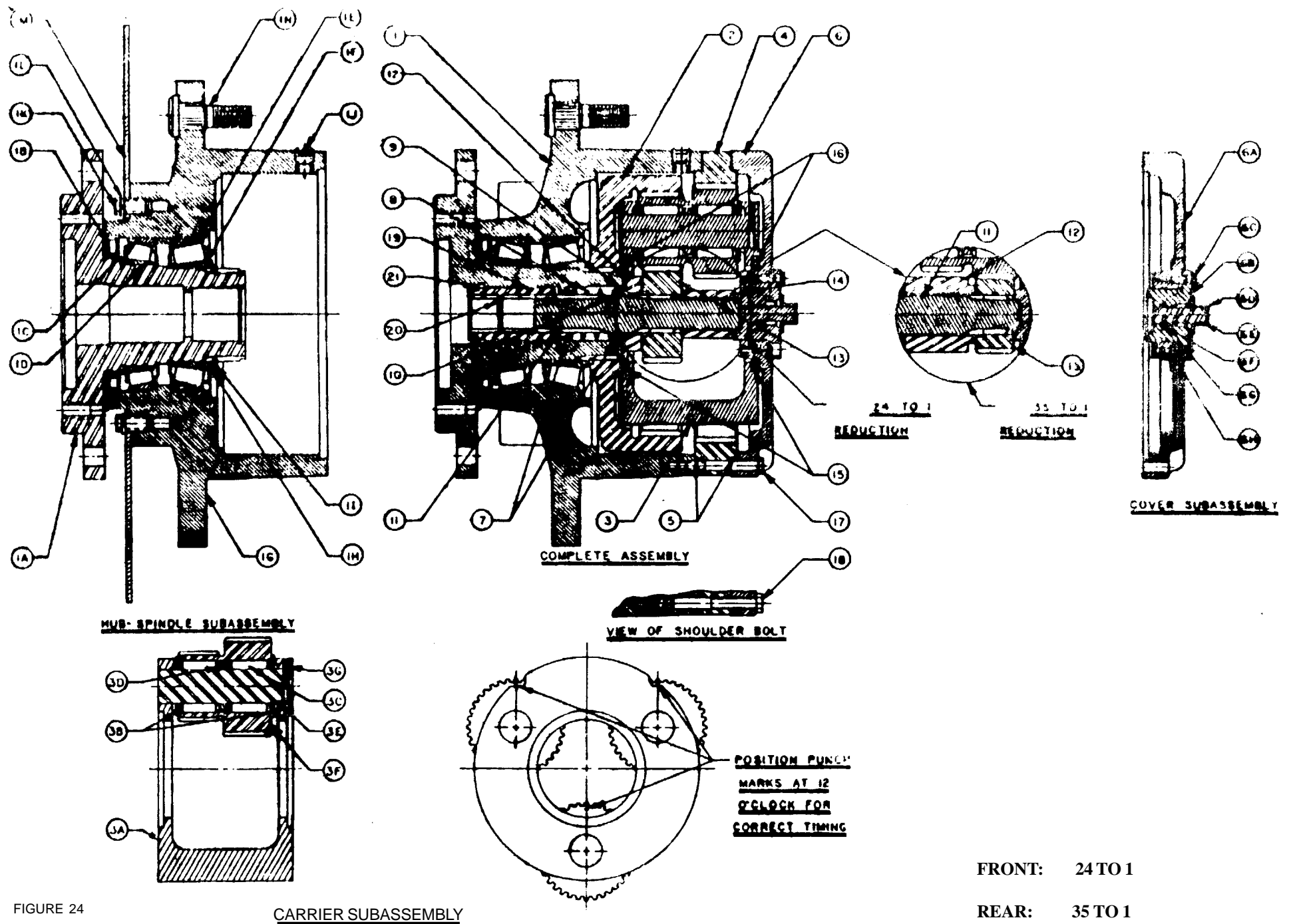

FIGURE 24

CARRIER SUBASSEMBLY

FRONT: 24 TO 1

REAR: 35 TO 1

HYDRAULIC PRESSURE CHECKS

NOTE: Do not attempt to adjust the hydraulic pressure settings on this machine. A change from the factory settings indicates a defective component. If an incorrect pressure is indicated, contact LOED Service Department for proper corrective action.

MAIN DRIVE

1. Connect a 5000 psi gauge to test point 1
2. Apply parking brake.
3. With machine in "HI" transmission range, 2 wheel drive ("HI" on shift knob) and low flow (1st gear), gauge should read 2750 psi at 2/3 throttle.

CONTROL VALVES

1. Connect a 5000 psi gauge to test point 2.
2. Operate the tilt circuit until the forks are rotated full up. Gauge should read 2500 psi.

TILT CIRCUIT PORT RELIEFS

1. Connect a 5000 psi gauge to test point 5.
 2. Rotate the forks full down.
 3. At 1/2 throttle, raise the boom. Gauge should read 2750 psi.
 4. Connect a 5000 psi "gauge to test point 6.
 5. Raise the boom. Rotate forks full up.
 6. At 1/2 throttle, lower the boom. Gauge should read 2750 psi.
- WARNING' Attempting to increase lifting capacity by increasing the pressure settings of the port relief valves will result in damage to the frame or cylinders.

STEERING

1. Connect a 5000 psi gauge to test point 3.
2. Turn wheels full left or right and hold against stop. Gauge should read 1800 psi before s/n 237 - 2500 psi s/n 237 and after.

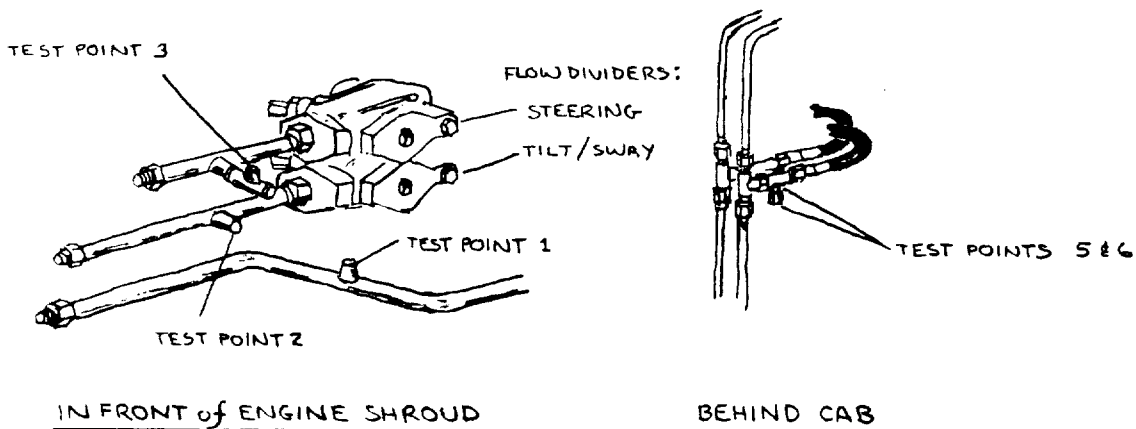

FIGURE 25

HYDRAULIC CYLINDERS

NOTE: Replace all seals whenever a cylinder is disassembled for repair.

DISSASSEMBLY

1. Remove cylinder from machine.
2. Use a spanner wrench and mallet to unscrew the rod bearing from the cylinder barrel. Do not use a pipe wrench to remove the bearing. The aluminum rod bearing may not unscrew if the cylinder is warm.
3. Carefully pull the rod assembly straight out of the barrel. Use air to work the piston to the end of its stroke if necessary.
4. Remove the piston retaining lock nut and slide piston off rod.
5. Slide the rod bearing off the rod.
6. Carefully inspect all parts for scoring or deep scratches. Replace as required.

REASSEMBLY

1. Clean all parts thoroughly.
2. Lubricate the rod seal and wiper with hydraulic oil and install in rod bearing. Replace bearing on rod.
3. Replace "O" ring in inner groove of piston and remount piston on rod. Examine nylon insert lock nut carefully to determine if reuse is advisable. Lubricate threads with hydraulic oil and torque nut to specification:

1"	Nut	150-175	lb	ft
1-1/2"	"	600-650	"	"
1-3/4"	"	950-1000	"	"
2-1/2"	"	1800-2000	"	"

4. Lubricate piston seal grooves with hydraulic oil.
5. Warm the teflon piston seals to approximately 110 - 120 F. (still comfortable to handle by hand) in warm water. Do not apply flame heat to seal

Work the piston seal into groove as quickly as possible, using installation tool or small pocket screwdriver with smooth edges to work the seal in one groove at a time.

Allow seal to cool 10-20 minutes to return to original diameter before assembling piston into barrel.

6. Position cylinder barrel vertically for reassembly of cylinder. Lubricate piston seals with hydraulic oil. Protect piston seals from being damaged by cylinder barrel threads with .0010 - .0015 shim stock during assembly. Lubricate with hydraulic oil and install new back-up ring and "O" ring in outer groove of rod bearing. Screw rod bearing into cylinder barrel and use spanner wrench and mallet to tighten until rod bearing flange is firmly sealed.

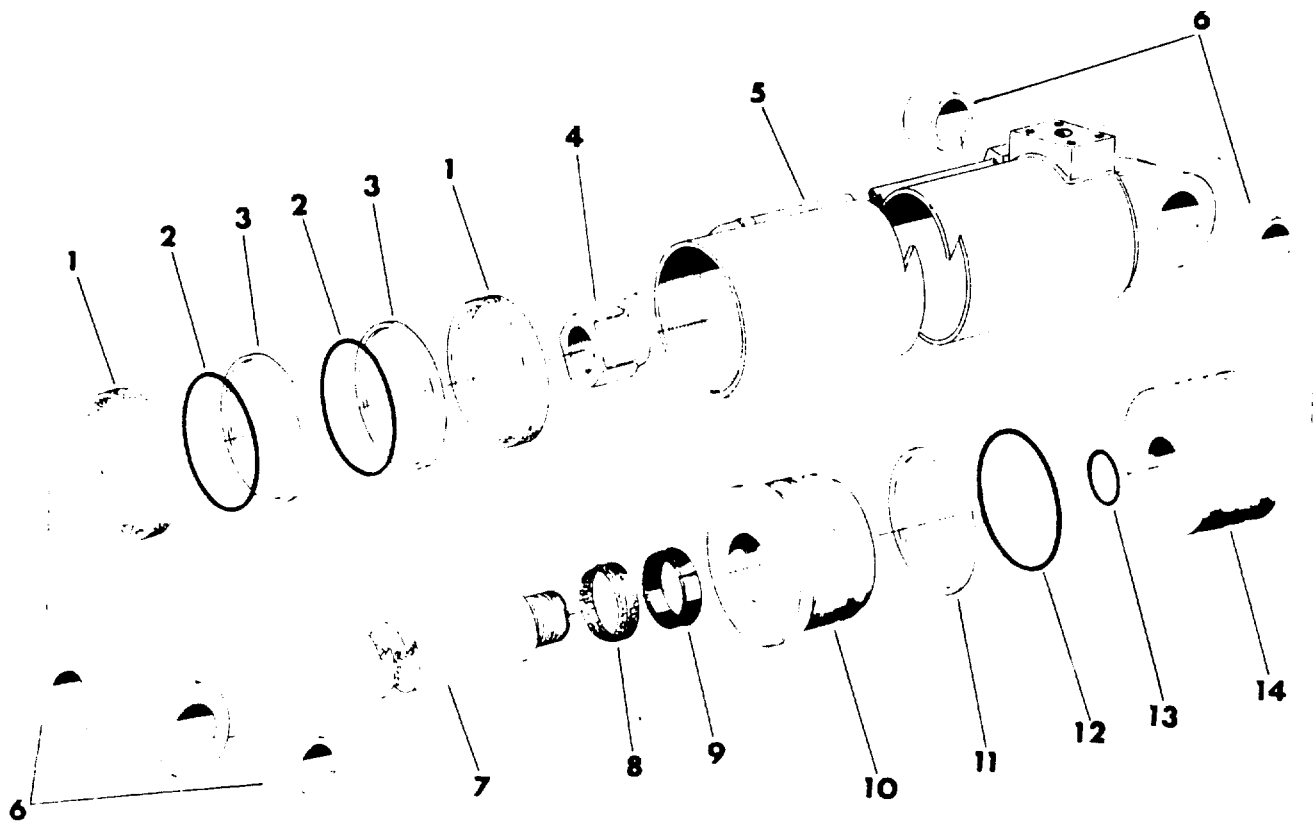

FIGURE 26

- | | |
|--------------------|----------------|
| 1. WEARING RING | 8. WIPERRING |
| 2. "O" RING | 9. RODSEAL |
| 3. PISTON SEAL | 10. RODBEARING |
| 4. NUT | 11. BACKUPRING |
| 5. CYLINDER BARREL | 12. "O" RING |
| 6. BUSHING | 13. "O" RING |
| 7. CYLINDER ROD | 14. PISTON |

SECTION V EMERGENCY PLUNGER AND HOUSING REPAIR

To manufacture a high quality control valve having a minimum amount of leakage, each plunger is honed to fit its respective bore. It is, therefore, recommended that the valve returned to the factory to repair or replacement.

Should a situation require rebuilding the valve, we recommend the following procedures:

- Remove valve from the equipment and thoroughly clean all external surfaces.
- Disassemble valve, tagging plungers to assure reassembly to the same bore. Do not damage plunger seals during disassembly.
- Clean all internal parts with solvent and blow dry with compressed air.
- Plate plunger .001 to .002 with crack-free chrome plate.
- Refinish plated plunger to within .0002 of being straight and round with a surface finish of 12 RMS or greater.
- Hone valve bore until plunger fits bore smoothly. Permissible clearance between bore and plunger is .0002 to .0005.
- Thoroughly flush valve housing, grease detents and other sliding parts and reassemble valve. During assembly do not damage plunger seals.

If a new plunger is required, refit new plunger to the respective bore using the same procedures as for a rebuilt plunger.

NOTE: HUSCO IS NOT ABLE TO PERFORM FACTORY REPAIR SERVICE WITHOUT WRITTEN AUTHORIZATION FROM THE ORIGINAL EQUIPMENT MANUFACTURER.

Returned valves will be held at HUSCO until authorization is obtained. All billing will be mailed to the original manufacturer. The manufacturer will, bill the owner of the equipment.

Valves will be shipped directly to the owner of the equipment unless otherwise instructed.

MINIMUM AND MAXIMUM LEAKAGE RATES			
DIA. OF SPOOL	MINIMUM	STANDARD	MAXIMUM
3/4"	1/8"	1/8"	1-1/4"
1	1/4"	1/4"	1-3/4"
1-1/4	3/8"	3/8"	3-1/2"
1-5/8	1/2"	1/2"	5"
2	3-1/2"	5-1/4"	7"

FIGURE 27

Plunger leakage allowance is tabulated in cubic inches per minute for a five minute average. Oil temperature of 80 F. with a viscosity of 145 to 155 S.U.S. of 100 f., and viscosity index of 95. Pressure constant at 1000 p.s.i.

If leakage exceeds maximum, the valve should be returned for factory rebuilding or replacement *

NOTE: ALL DYNAMIC SEALS ARE MADE OF SPECIAL COMPOUNDS AND SHOULD BE PURCHASED FROM HUSCO OR AN APPROVED SOURCE.

HUSCO MODEL "5000" SECTIONAL VALVE SERVICE INFORMATION

The design and construction of the HUSCO Model 5000 Sectional Valve allows for easy service or replacement of the various sections, seals and components. All parts are available for replacement with the exception of furnishing separately either the plunger housing or the plunger. They are selectively fit and are available as a complete unit. Should either require repair, it will be necessary to return the complete plunger section.

To perform service operations, it is recommended that the valve be removed from the machine. However, in some instances, it is only necessary to remove the parts or sections requiring service or replacement. In either case, the exterior of the valve must be thoroughly cleaned before disassembly.

MAINTENANCE PROCEDURE

Valve Disassembly

Remove tie rod nuts from one side of valve and carefully slide valve sections across tie rods to avoid losing circuit check poppet and spring, which is enclosed between plunger sections. This poppet must be kept with respective plunger section and should be tagged. An O-ring is also present between the sections, and can be removed. When separating sections, extreme care must be exercised not to damage machined sealing surfaces. Place section on a clean surface.

● Plunger End Seals

An O-ring plunger seal, protected by a one piece molded wiper, is used at each end of the plunger. To replace them, remove the seal plates and plunger control from the cap end. After seals are removed, inspect seal counterbores so that surfaces are smooth and completely free of dirt, pits, rust, and metal particles. Select new seal and wiper and coat them with hydraulic oil. Thoroughly clean seal counterbore in housing and install O-ring, followed by wiper. Install seal plates and plunger controls.

If for some reason, it is necessary to remove plungers, they should be tagged for their respective plunger sections. Switching them will result in incorrect clearances, causing either binding and sticking or excessive leakage.

● Circuit Check Valves

The circuit check valves are of the poppet type and are spring loaded. They are retained in one side of the machined surface of each plunger section and normally require very little service.

Check valve malfunctioning is usually the result of foreign matter lodging between the seat and the poppet. Examine seat for dirt or metal particles. Check seating face for nicks or scratches and, if present, they can be removed by lapping, using fine lapping compound; however, care must be exercised to prevent lapping compound from entering or remaining in valve. Examine spring and replace if it is weak, broken, or distorted.

● Section Seal

All machined surfaces between inlet and outlet sections (which includes plunger sections) are ground and must be free of dirt or any raised burrs. If present, they must be removed by lapping on a perfectly smooth flat steel surface using fine lapping compound. Clean section very thoroughly to avoid lapping compound from remaining in any of the valve passages.

Examine machined O-ring counterbore so that surfaces are smooth and completely free of dirt, pits, rust, and metal particles. Select new O-ring and, after thoroughly cleaning counterbore, install it.

● Assembling Sections

Place the various sections in the proper order, making certain the circuit check poppet and spring are positioned properly in the plunger section, and install the tie rods. The top one is 3/8 dia. and the others 5/16 dia. Assemble the nuts and, using a torque wrench, apply 33 ft. lbs. of torque to the top one and 14 ft. lbs. to the others.

● Cartridge Main Relief

See service information Page 4 in this section.

TESTING PLUNGER LEAKAGE

To check the leakage rate of the plungers, install a good accurate pressure gauge in the cylinder port that is controlled by the plunger to be tested. Actuate the plunger until full relief valve pressure is indicated on this gauge. Return plunger to neutral. The rate at which the pressure drops is an indication of the leakage past the plunger. The rate of drift of the cylinder is also an indication. Care must be exercised in interpreting these results, as leakage past the cylinder packings is also included in these determinations.

TESTING CIRCUIT CHECK VALVE

The circuit check valves can be tested in a similar manner. With full relief pressure in the cylinder port and the plunger in the operating position, stop the pump and check the rate of pressure drop in the cylinder port. It must be noted that this pressure drop reflects not only the leakage past the check valve and cylinder packing but also the leakage around the plunger.

MAINTENANCE PROCEDURES LOAD CHECK VALVES

C. LOAD CHECK VALVES

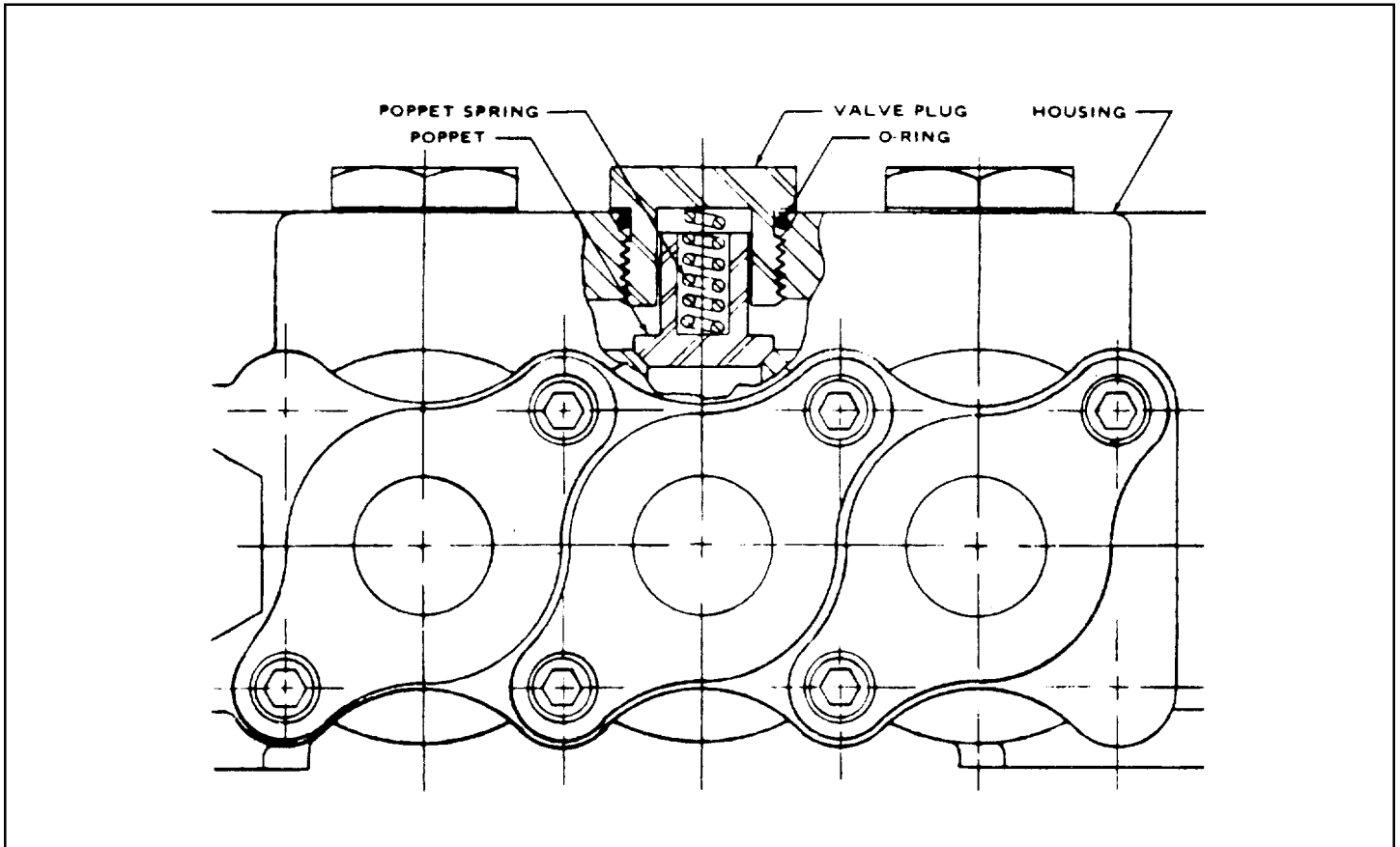

FIGURE 28

Load Check Valve

Load check valves used on HUSCO control valves normally do not require servicing; malfunction is usually the result of foreign matter lodging between the seat and poppet.

DISASSEMBLY

Remove valve plug, poppet spring and poppet.

INSPECTION AND REPAIR

Clean parts with solvent and blow dry with compressed air. Examine poppet and poppet seat for nicks or scratches. Minor nicks or scratches can be removed by lapping poppet and seat with a fine grade lapping compound.

CAUTION: DO NOT ALLOW LAPPING COMPOUND TO REMAIN IN VALVE.

Replace O-ring if damaged or deteriorated. Replace spring if weak or distorted.

ASSEMBLY

Assemble poppet and poppet spring to housing. Replace O-ring to valve plug to housing.

FIELD TESTING PROCEDURES

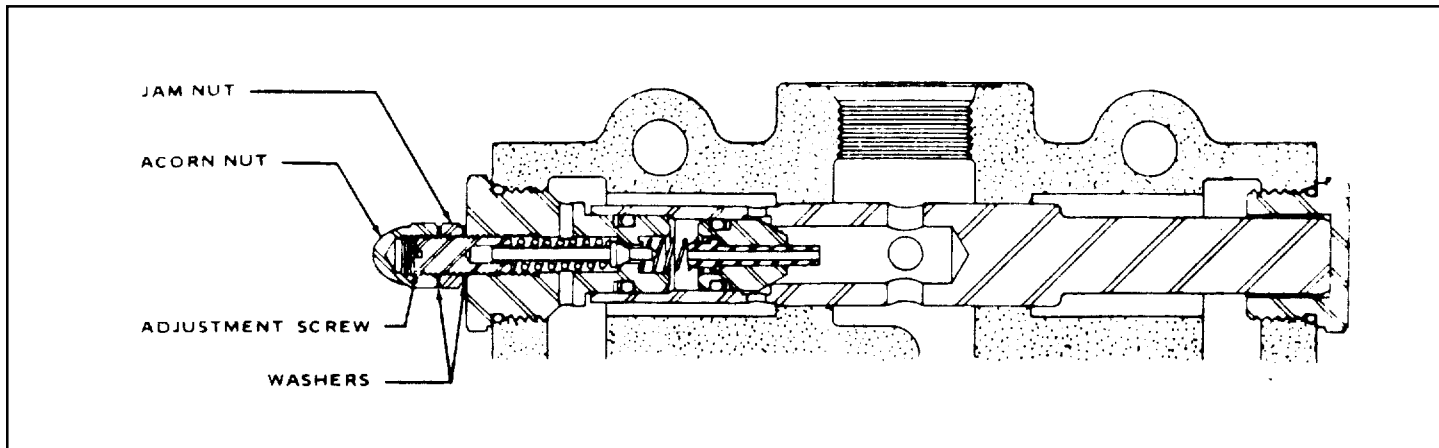

FIGURE 29

Pilot Operated - Sleeve Type Main Relief Valve

To set main relief valve pressure, install a pressure gauge in the inlet line and set pressure as follows

Remove acorn nut and loosen jam nut.

Back off pilot adjustment screw and reset so that pilot adjustment screw just seats against pilot poppet.

Run engine at normal operating speed.

Operate one plunger of the control valve at the extreme position until a pressure reading is observed. Reset adjustment screw until desired pressure obtained.

Holding adjustment screw at this setting, tighten jam nut and install acorn nut.

Retest to check pressure setting.

NOTE: THE ABOVE SETTING WILL PRODUCE A RELATIVELY CONSTANT RELIEF VALVE SETTING ACROSS FULL ENGINE RPM.

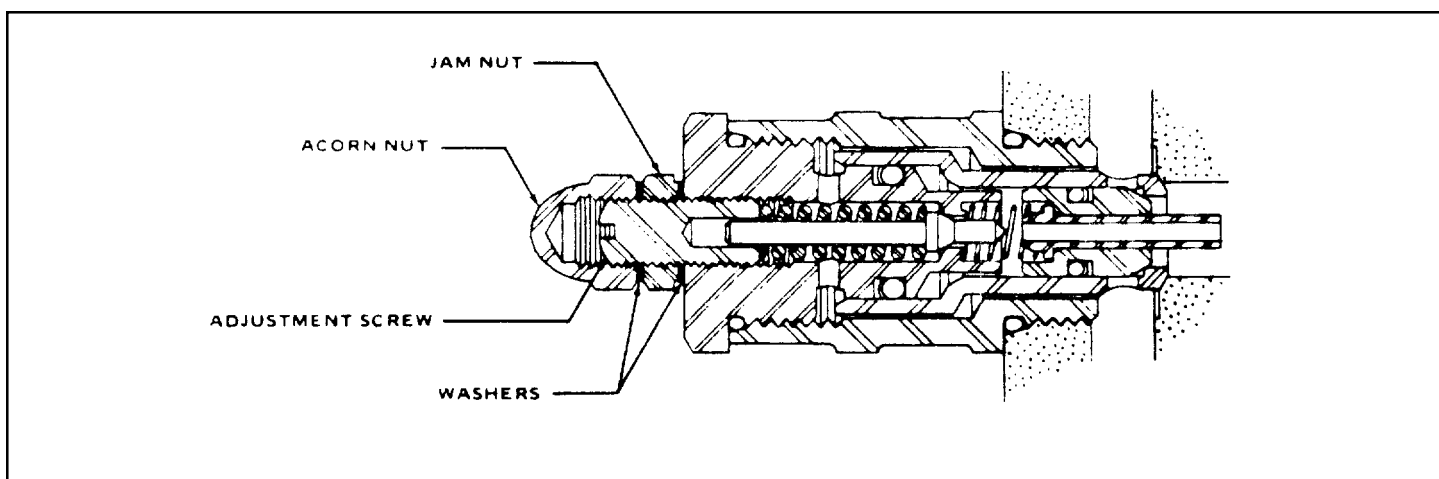

FIGURE 30

Cartridge Type - Main Relief Valve (identical in design port relief valve).

To set pressure on the Service Port Relief Valve, install a good pressure gauge in the line which is in communication with the Service Port Relief Valve. Apply a load to reach the set pressure of the Service Port Relief unit. Then proceed as outlined for Fig. 29 (See Above).

NOTE: THE VOID CONTROL FEATURE IS DESIGNED TO OPERATE WHENEVER THE CYLINDER PORT PRESSURE IS LOWER THAN THE RESERVOIR PRESSURE AND IS NOT ADJUSTABLE.

MAINTENANCE PROCEDURES - RELIEF VALVES

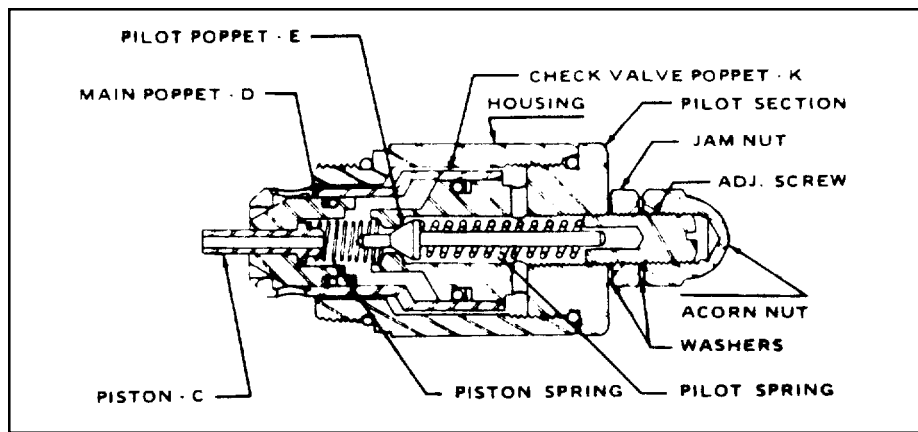

FIGURE 31

. Service Port Relief Cartridge

DISASSEMBLY

The cartridge type service port reliefs used in the Husco valves are of the pilot poppet type with external adjustment. Any malfunctioning is usually the result of foreign matter lodging between the piston, relief valve poppet, and check valve.

To service, clean the surrounding area and remove the complete relief valve cartridge.

The design, of the pilot poppet and pilot poppet seat provides positive seating and seldom requires any maintenance. Therefore, the pilot section, check valve poppet and other internal parts, can be removed from the cartridge without disturbing the valve setting. Disassemble these parts and examine for foreign matter.

INSPECTION AND REPAIR

Examine the seat in the main valve housing, if grooves or ridges are present, the valve must be returned to Husco for re-machining.

All seats and seating surfaces should be smooth and free of nicks, scratches or grooves. Examine O-rings and back-up washers for any damage. Replace damaged or faulty parts. All moving parts should slide, freely with only seal friction present.

If operating difficulties indicate that the pilot poppet is leaking or sticking, remove internal parts of the pilot section and follow same procedure as above.

ASSEMBLY

After inspecting and cleaning, immerse all parts in hydraulic oil and re-assemble. Since pressure setting was not disturbed, unit can be tested for proper functioning under actual working conditions.

There are several variations to service port relief. However, all are similar in nature regarding service and repair (see Maintenance Procedure Relief Valves, Page 7).

TROUBLE SHOOTING - SERVICE PORT RELIEF CARTRIDGE

TROUBLE	PROBABLE CAUSE	REMEDY
Can't get pressure.	1. Poppet D, E or K stuck open or dirt under seat.	Check for foreign matter between poppets D, E or K and their mating members. Members must slide freely.
Erratic pressure	1. Pilot poppet seat damaged. 2. Poppet C sticking in D.	Replace damaged parts. Clean dirt and remove surface marks for free movement.
Pressure setting not correct	1. Wear due to dirt. 2. Lock nut & adj. screw loose.	See "How to set pressure on service port relief" (Fig. 27, Page 26).
Leaks	1. Damaged seats. 2. Worn O-rings. 3. Parts sticking due to dirt.	Replace worn or damaged parts. Inspect for free movement of components. Check seats for scratches, nicks or other marks.

FIGURE 32

MAINTENANCE PROCEDURES - PLUNGERS

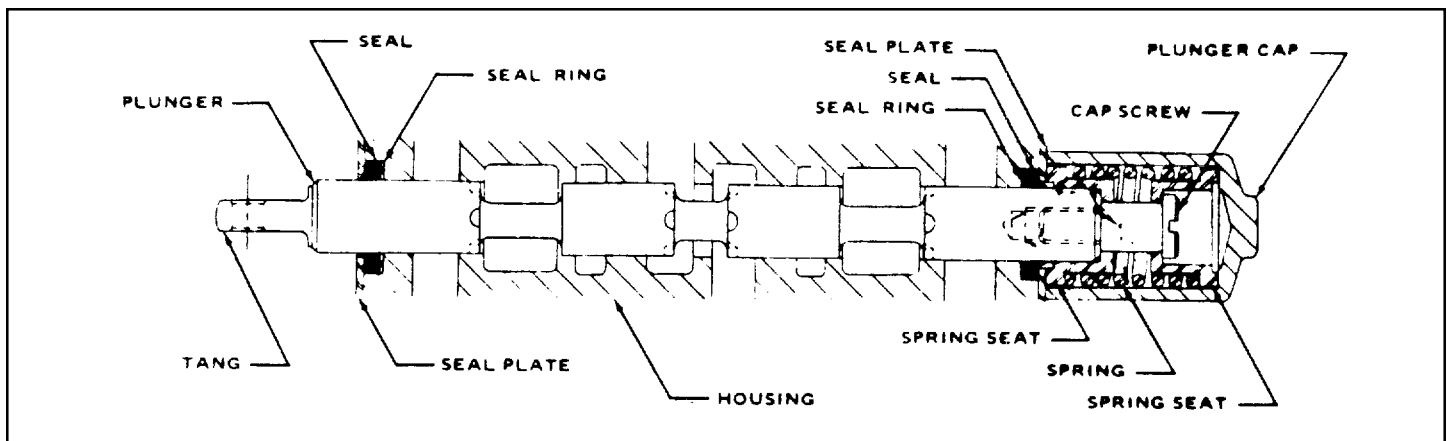

FIGURE 33

Double Acting - Spring Centered Plunger (Hydraulically Balanced)

SEAL REPLACEMENT

A one piece molded combination wiper and seal is used at each end of the plunger. The seals are positioned with a seal ring and retained by seal plates. To replace seal at tang end of plunger, remove screws and seal plate from housing. Carefully remove seal and seal ring from housing. Seal groove must be smooth and completely free of dirt, pits, and metal particles. Examine lip of new seal for damage or mars. Replace seal ring and press firmly in place with a blunt tool (seal ring must fit in molded recess of seal to seat properly). Replace seal plate and round head screws.

To service seal at cap end of plunger, remove plunger cap from housing. Insert a pin through hole of tang and through tang hole of an adjacent plunger to prevent plunger from turning. Remove cap screw from end of plunger. Remove spring seats, plunger spring and seal plate from end of plunger. Remove seal and seal ring from housing. Seal grooves must be smooth and completely free of dirt, pits, and metal particles. Examine lip of new seal for damage or mars. Replace seal ring and press seal firmly in place with a blunt tool (seal ring must fit in molded recess of seal to seat properly). Assemble seal plate, inner spring seat, spring and outer spring seat to plunger with cap screw. Assemble plunger cap to housing.

DISASSEMBLY

NOTE: DURING DISASSEMBLY PLUNGERS MUST BE TAGGED TO ASSURE REASSEMBLY TO THE SAME BORE.

Remove round head screws, seal plate, seal and seal ring from tang end of housing. Remove plunger cap. Insert pin through hole of an adjacent plunger to prevent plunger from turning. Remove cap screw from end of plunger. Remove spring seats, plunger spring and seal plate. Carefully withdraw plunger from housing, tang end first. Remove seal and seal ring.

INSPECTION AND REPAIR

Clean all parts with solvent and dry with compressed air. Examine wiper seal for cuts, nicks, deterioration or hardening. Replace if necessary. Replace plunger spring if broken or distorted.

ASSEMBLY

Thoroughly clean sealing surfaces of housing. Install seal ring at tang end and press seal firmly in place with a blunt tool (seal ring must fit in molded recess of seal to seat properly). Replace seal plate. Coat the seal wiper lips with clean oil. Insert plunger into housing, tang end first from cap end. Work plunger carefully through seal. Assemble seal ring and seal to cap end of plunger. Press seal firmly in place with a blunt tool (seal ring must fit in molded recess of seal to seat properly). Replace seal plate, inner spring seat, spring and outer spring seat to plunger with cap screw. Insert pin through hole of tang and through tang hole of an adjacent plunger to prevent plunger from turning; tighten cap screw. Assemble plunger cap to housing.

MAINTENANCE PROCEDURES - RELIEF VALVES

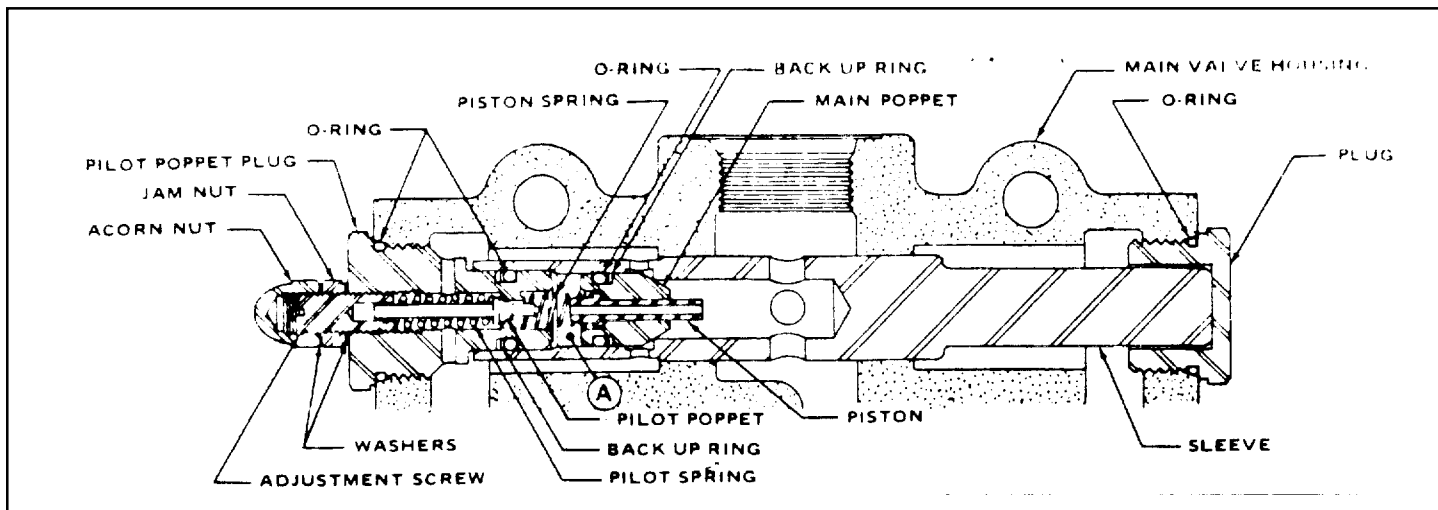

FIGURE 34

Relief Valve - Pilot Operated (External Adjustment)

The Cartridge relief valve shown in Figure -1 is of the differential area type. When fluid enters the relief valve through the hole in the piston, an unbalanced condition in this area keeps main poppet and piston tightly sealed.

As system pressure exceeds the relief valve setting, the pilot poppet is unseated, allowing oil to flow around the pilot poppet stem through the holes in the pilot poppet plug and into the low pressure area. This oil flow reduces the pressure in area (A) allowing the piston to seat against the pilot poppet. The seating of the piston shuts off the oil flow through the sensing hole in the piston. Oil pressure in area (A) is greatly reduced thus allowing the main poppet to unseat. System fluid is then dumped instantaneously to low pressure. (For detailed theory of operation see page 8.).

DISASSEMBLY

Remove pilot poppet plug assembly and plug from housing. Remove piston spring and piston from sleeve. Using brass rod, carefully drive sleeve out through valve plug end of housing. Main poppet can then be removed by tapping sleeve into palm of hand. Pilot poppet in the pilot poppet plug assembly is preset at the factory; further disassembly will alter this setting and is not recommended. If, however, it is necessary to disassemble, remove acorn nut, lock nut and the two washers from the adjustment screw. Remove all O-rings and spiral back up rings.

INSPECTION AND REPAIR

NOTE. THE MOST COMMON CAUSE OF RELIEF VALVE FAILURE IS DAMAGED OR FATIGUED O-RINGS. IT IS, THEREFORE, RECOMMENDED THAT NEW O-RINGS BE INSTALLED.

Clean all parts in solvent and dry with compressed air. Inspect seating surfaces of poppets and piston for nicks, grooves and excessive wear. The seating edge of the sleeve must be sharp and free from nicks. Check the sensing hole in the piston, hole in the pilot poppet plug assembly, and holes in the sleeve for obstructions. Assemble piston to the main poppet. It is essential that the piston move freely through the hole in the main poppet. Any parts found to be faulty must be replaced.

ASSEMBLY

Assemble and position all O-rings and spiral back up rings as shown in Fig. 34. Stretch O-rings into position (do not roll). Insert pilot poppet and pilot poppet spring into valve plug and install the adjustment screw. Lubricate main poppet with hydraulic oil and insert it with piston and piston spring into sleeve. Lubricate this assembly and mate with sleeve. Install this assembly in the valve housing. Because the sleeve is a honed fit, gentle tapping may be required to install. Care must be exercised to avoid damaging the control valves internal lands. Install plug to, valve housing. Acorn nut, lock nut and washers can be assembled after relief cartridge is adjusted.

MAINTENANCE PROCEDURES - RELIEF VALVES

A combination cylinder relief valve and anti-void unit is illustrated in Figure 5 8. The service port relief valve is designed to control the maximum pressure obtained in the circuit. By discharging oil to the low pressure return passage, the service port relief valve provides maximum structural protection of circuit components. It will function whether the plunger is in the neutral or operate position.

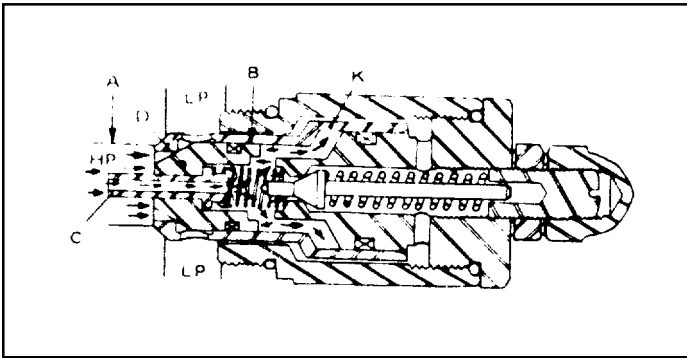

FIGURE 35

Step 1

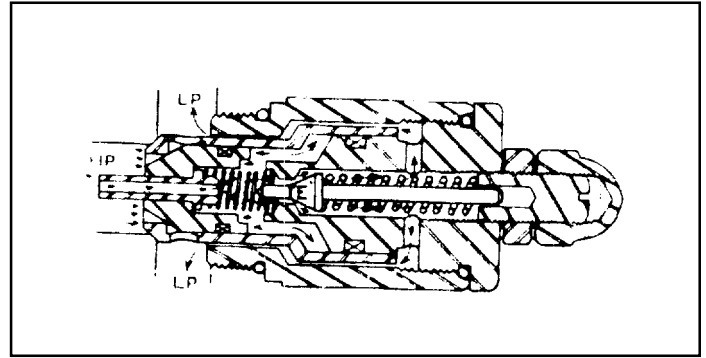

FIGURE 36

Step 2

The normal operating sequence for the cylinder port relief is as follows - the relief is in communication between the cylinder port "HP" and low pressure "LP". Oil is admitted through the hole in piston "C" and because of the differential area between diameters "A" and "B" main poppet "D" and check valve poppet "K" are tightly seated. (See Fig. 35)

The oil pressure in the cylinder port "HP" has reached the setting of the pilot poppet spring force and unseats the pilot poppet "E" and oil flows around the poppet - through the cross drilled holes and to the low pressure area "LP". (See Fig 36)

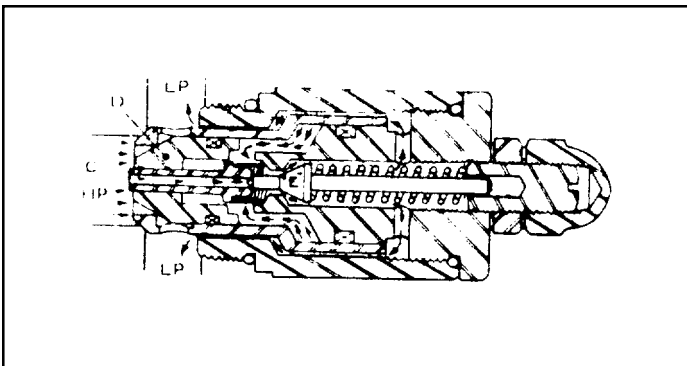

FIGURE 37

Step 3

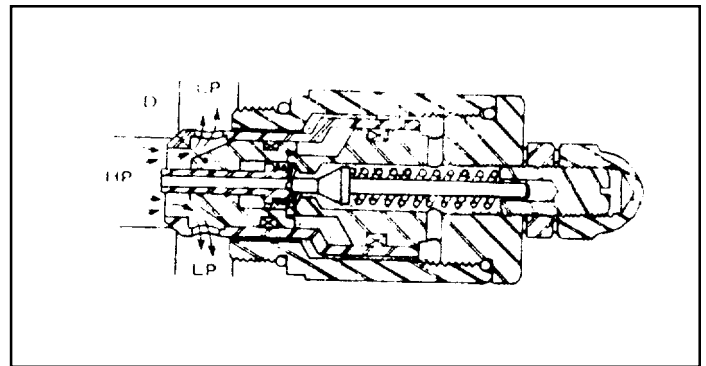

FIGURE 38

Step 4

The loss of oil behind piston "C" effected by the opening of pilot poppet "E", causes piston "C" to move back and seat against pilot poppet "E". This shuts off the oil flow to the area behind main poppet "D", and causes a low pressure area internally. (See Fig. 37)

The imbalance of pressure on the inside as compared to that of the cylinder port "HP", forces the main poppet "D" to open and relieve the oil directly to the low pressure chamber "LP" in the valves. (See Fig. 38)

INTRODUCTION

The following information relates to the main and auxiliary hydraulic control valves used on the LOED Handler.

GENERAL INFORMATION

Disassembly and repair procedures are included in this Manual for the different types of relief valves, plunger styles, check valves, and special devices incorporated in the HUSCO control valves. All parts are available for replacement except the valve housing and plungers. The plungers are custom fit to the respective bore with extremely close tolerances AND ARE NOT INTERCHANGEABLE. Whenever excessive wear or damage occurs to the plunger or bore, return valve to factory for rebuilding or replacement.

NOTE

Remove valve from machinery and thoroughly clean the exterior before attempting any disassembly. Disassemble on an area that is free of dirt and corrosive material.

When servicing or rebuilding a valve, it is important to lubricate disassembled parts to prevent corrosion.

The following lubricants are recommended:

Lubriplate No. 105

coating seals and "O" Rings.

Lubriplate No. 630 AA

springs, detent parts, plunger end assemblies and any

parts not normally immersed in the hydraulic oil.

NOTE: ALL DYNAMIC SEALS ARE MADE OF SPECIAL COMPOUNDS AND SHOULD BE PURCHASED FROM LOED.

TROUBLE SHOOTING

Trouble	Probable Cause	Remedy
Load will not hold	<ol style="list-style-type: none"> 1. Cylinder leaking or worn. 2. Oil bypassing valve plunger. 3. Port relief valve not holding. 	<p>Check cylinders.</p> <p>Replace valve.*</p> <p>Remove and clean.</p>
Load drops when plunger moved from neutral	<ol style="list-style-type: none"> 1. Dirt in check valve. 2. Scored check valve poppet or seat. 	<p>Disassemble and clean.</p> <p>Replace poppet or lap poppet to seat.</p>
Poor hydraulic system performance or failure.	<ol style="list-style-type: none"> 1. Defective pump. 2. Dirt in relief valve. 3. Relief valve defective. 4. Worn cylinders. 5. Load too heavy. 6. Internal valve crack. 7. Plunger not at full stroke. 8. Reservoir low on oil. 9. System filter clogged. 10. Line restricted. 	<p>Check pressure or replace.</p> <p>Disassemble and clean.</p> <p>Check as per instructions.</p> <p>Repair or replace.</p> <p>Check line pressure.</p> <p>Replace valve.*</p> <p>Check movement and linkage.</p> <p>Add oil.</p> <p>Clean or replace.</p> <p>Check lines.</p>

FIGURE 39

SECTION II TROUBLE SHOOTING

Trouble	Probable Cause	Remedy
Sticking plungers	<ol style="list-style-type: none"> 1. Excessively high oil temperature. 2. Dirt in oil. 3. Pipe fittings too tight. 4. Valve warped from mounting. 5. Excessively high pressure in valve. 6. Handle or linkage binding. 7. Plunger bent. 8. Return spring damaged. 9. Spring or detent cap binding. 10. Valve not at thermal equilibrium. 	<p>Eliminate restriction in pipe lines and filtering system.</p> <p>Change oil - clean system.</p> <p>Check torque.</p> <p>Loosen valve and check.</p> <p>Check with gauge on inlet and cylinder lines.</p> <p>Free up linkage.</p> <p>Replace valve.*</p> <p>Replace faulty parts.</p> <p>Loosen cap, re-center and re-tighten.</p> <p>Let system warm up.</p>
Leaking seals	<ol style="list-style-type: none"> 1. Paint on or under seal. 2. Excessive back pressure. 3. Dirt under seal. 4. Scored plunger. 5. Loose seal plates. 6. Cut or scored seal. 	<p>Remove and clean.</p> <p>Open or enlarge line to reservoir.</p> <p>Remove and clean.</p> <p>Replace valve.*</p> <p>Clean and tighten.</p> <p>Replace faulty parts.</p>
Detent control fails to hold	<ol style="list-style-type: none"> 1. Worn detent cam. 2. Spring or ball broken or deformed. 3. Excessive vibration. 4. Plunger stroke restricted. 5. Weight of lever excessive. 	<p>Replace worn parts.</p> <p>Replace damaged parts.</p> <p>Insulate valve and handle linkage.</p> <p>Check linkage.</p> <p>Check linkage and mechanism.</p>
Unable to move plunger in or out.	<ol style="list-style-type: none"> 1. Dirt in valve. 2. Plunger cap full of oil. 3. Bind in linkage. 	<p>Clean and flush out.</p> <p>Replace seals.</p> <p>Free up linkage.</p>

FIGURE 40

**MAINTENANCE PROCEDURES - FORWARD - REVERSE VALVE
(Disassembly)**

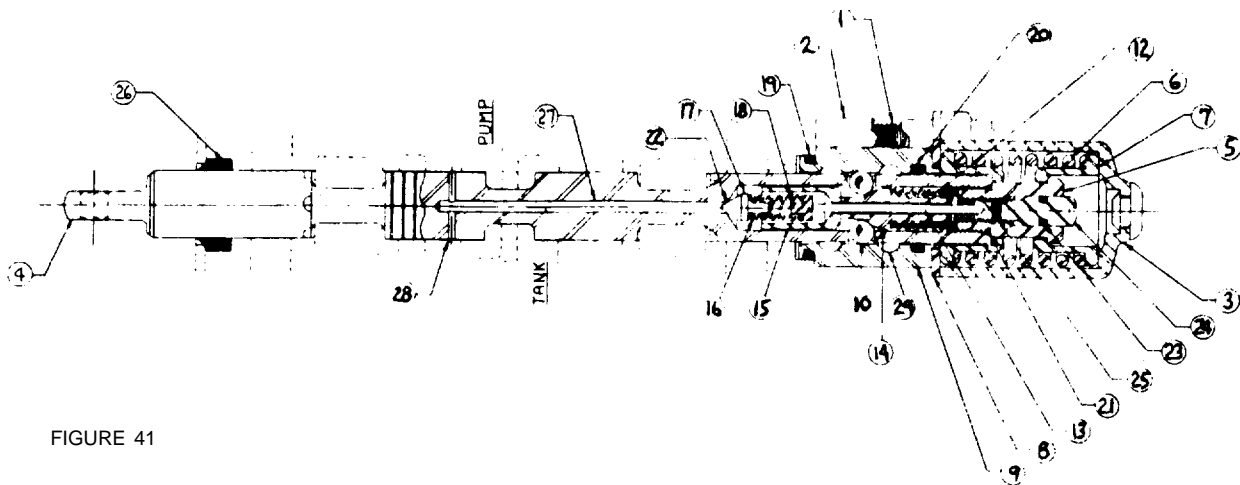

FIGURE 41

- | | |
|---|--|
| <p>Step 1: Remove socket head cup screws (No. 1), spacers (No. 2), and plunger cap (No. 3).</p> <p>Step 2: Insert rod through all holes in tang end of plungers (No. 4) This will prevent the plunger from turning.</p> <p>Step 3: Use a special spanner wrench to remove the special cap screw (No. 5) that holds the plunger spring (No. 6) to spring seats (No. 7) and seal plate (No. 8). Remove these parts slowly to prevent them from being lost.</p> <p>Step 4: Take a firm hold on the detent sleeve (No. 9) slowly rotate while gently pulling the detent sleeve backwards.</p> <p>Step 5: As the detent sleeve (No. 9) is being pulled backwards, place the other hand under and around the plunger (No. 4) so that when the balls (No. 10) are exposed, your hand will catch them.</p> <p>Step 6: Remove rod from the hole in the tang ends of the plunger (No. 4).</p> <p>Step 7: Remove any balls (No. 10) that are left in the plunger (No. 4) by slowly rotating the plunger and catching the balls as they drop out.</p> <p>Step 8: Take a firm hold of the plunger (No. 4) and pull it out of the housing (No. 11). Be careful of any accumulation of oil that may be in the plunger bore of the valve housing.</p> <p>Step 9: While holding the plunger (No. 4) in your hand, tip the plunger up and catch the spring (No. 12), adjust rod (No. 13), cam (No. 14), sleeve (No. 15), spring (No. 16), poppet (No. 17), and spring guide (No. 18) that is inside of the plunger.</p> <p>Step 10: The seal (No. 26) at the tang end of the plunger (No. 4) is serviced in the same manner as for the spring-centered plunger previously discussed on page B-7.</p> <p>Step 11: To replace the "O" ring (No. 19) on the outside of the detent sleeve (No. 9), insert a small screw driver or similar instrument under the "O" ring and gently lift it from its seat. Wash the "O" ring groove and replace the worn or damaged "O" ring with a new one being careful not to damage it.</p> <p>Step 12: To remove the "O" ring (No. 20) from the detent sleeve (No. 9), use a thin sharp instrument to get behind the "O" ring to extract it from the groove. If you are unable to get an instrument behind the "O" ring, insert the instrument into the "O" ring and remove it from the groove. Before inserting a new "O" ring into the groove be sure the "O"</p> | <p>Continued ring groove is clean and has not been damaged in any way. Insert plunger (No. 4) through the detent sleeve until the rear of the plunger is even with the bottom edge of the inner "O" ring groove. Lubricate the "O" ring with oil and gently insert it into the "O" ring groove. Use a thin round edge tool for this operation. Always proceed with caution so as not to damage the "O" ring in any way.</p> <p>Step 13: Remove the "O" ring (No. 21) on the special cap screw in same manner as described in Step 12. To replace the "O" ring, first put the "O" ring partly over the edge of the threaded end and hold it with your thumb. Now, insert a small diameter round edge tool under "O" ring and while using a circular motion, stretch the "O" ring down and over the threads to the "O" ring seat. NEVER roll the "O" ring over the threads to the seat.</p> <p>Step 14: Inspect adjust rod (No. 13.) If this rod is bent, replace it with a new one.</p> <p>Step 15: Check the face of the small poppet (No. 17) and the poppet seat (No. 22) inside of the plunger (No. 4). If poppet face (No. 17) or poppet seat in the plunger is worn or marred, use a fine lapping compound on the poppet and gently lap these parts until seat and poppet face are free of any irregularities. Be sure to cleanse both the poppet and the inside of the plunger of any lapping compound.</p> <p>Step 16: If "O" ring (No. 23) on adjust screw (No. 24) needs to be replaced, back out adjust screw from special cap screw (No. 5); remove the "O" ring and replace it with a new one.</p> <p>Step 17: To replace nylon insert (No. 25), first remove it from the adjust screw (No. 24) using a rod or drill with an O.D. a little smaller than the I.D. of the hole. Install a new insert making sure the insert fits snug in the hole and does not protrude past the crest of the threads on the adjust screw.</p> <p>Step 18: NOTE: If adjust screw (No. 24) has been turned in the special cap screw (No. 5) or removed, this will change the setting of the kickout pressure and must be reset (Step 19).</p> <p>Step 19: To reset the kickout pressure setting, first install a pressure gage in the cylinder port line, which is in communication with the cylinder port for this plunger. Move the plunger into an operating position and apply pressure at high idle. Adjust in this manner until desired kickout pressure is reached. Never set the plunger kickout pressure higher than the main relief valve pressure setting.</p> |
|---|--|

**MAINTENANCE PROCEDURE - FORWARD - REVERSE VALVE
(Reassembly)**

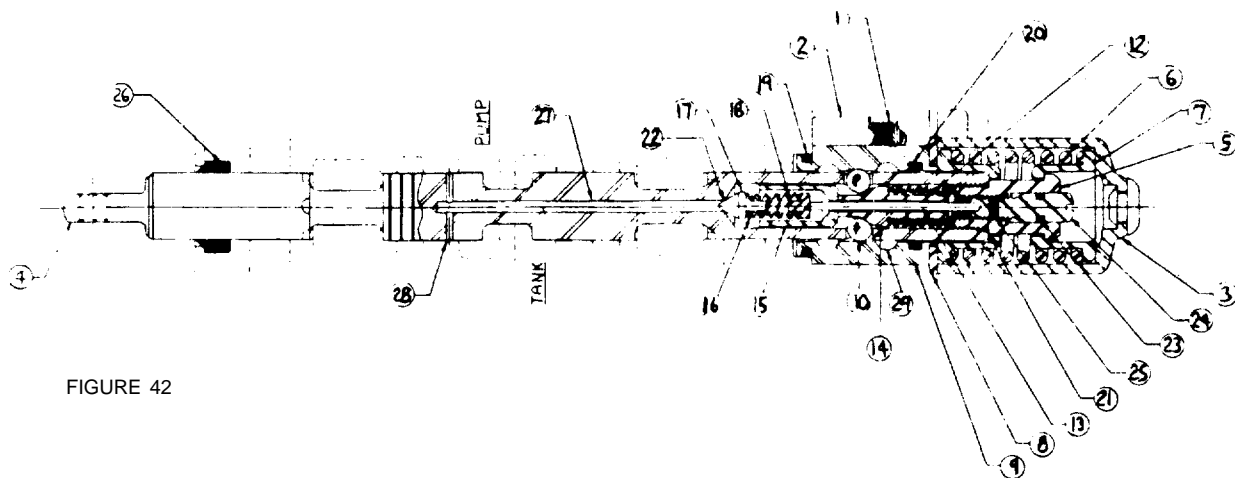

FIGURE 42

- | | |
|---|--|
| <p>Step 1: Clean all parts in solvent and blow dry with compressed air. Inspect all parts and if any are found to be worn or deformed replace them with new ones.</p> <p>Step 2: Clamp tang end of plunger (No. 4) in a vise. To clean the pilot hole (No. 27) that runs down through the inside of the plunger to the cross hole (No. 28), use a rod or a drill with an O.D. approximately the same size as the hole. Insert the instrument through the passage several times being careful at all times not to mar the seat on which the poppet rests. To clean the cross hole at the bottom of the passage, use an instrument in the same fashion as previously described. Now blow the entire passage out with compressed air.</p> <p>Step 3: Insert the small spring (No. 16) over the end of the small poppet (No. 17). Now insert the small spring guide (No. 18) into the other end of the spring. Take this assembly and slip it into the sleeve (No. 15) with the poppet exposed. Insert the adjust rod (No. 13) through the hole in the end of the sleeve. The cam (No. 14) now slides over the adjust rod, and the larger spring (No. 12) slides over the end of the cam.</p> <p>Step 4: Insert this assembly into the end of the plunger (No. 4), making sure that all parts stay in alignment. Do not insert this assembly too far or the ball holes (No. 29) will be closed off by the cam (No. 14).</p> <p>Step 5: Form a cup around the ball holes (No. 29) your finger and slowly insert the balls (No. 10). If any difficulties are experienced in keeping the balls in place apply a small amount of grease (lubricate #630-AA) in the ball holes. While holding the balls, slip the detent sleeve (No. 9) down over the plunger (No. 4) gently pushing your fingers off the balls while at the same time the balls are being inserted into the detent sleeve. Once the balls are inside the sleeve take your thumb and apply a little pressure on the spring (No. 12) and gently move the sleeve until you feel the balls positioned in the detent sleeve.</p> <p>Step 6: Since the seal and wiper (No. 26) at the tang end of the valve need not be removed when servicing the automatic kickout assembly, no instructions are needed at this time for their removal or assembly. If this seal and wiper do require inspection or repair, proceed as per instructions on page B-10 and Figure #12, page 15.</p> | <p>Step 7: Take the plunger (No. 4) out of the vise and dip the tang end in oil. Now gently insert it into the plunger bore of the housing (No. 11) being careful not to move the detent sleeve (No. 9). Insert the plunger into the bore until the detent sleeve touches the counterbore of the housing. Now gently push forward on the sleeve and the plunger until the "O" ring (No. 19) on the detent sleeve is seated in the counterbore. Use a left-to-right half-rotation motion when inserting the "O" ring on the cam (No. 14) into the counterbore. Do not force the "O" ring into the counterbore.</p> <p>Step 8: Put the seal plates (No. 8) over the plunger (No. 4) onto the detent sleeve (No. 9). Now install spring guide (No. 7), spring (No. 6), and another spring guide. Insert special cap screw (No. 5).</p> <p>Step 9: Insert round hardened rod through tang holes in end of plungers (No. 4). This will prevent the plungers from rotating. Be sure the valve is bolted to the mounting plate or secured in some fashion that, when pressure is applied to the special cap (No. 5), your valve will not move.</p> <p>Step 10: Take spanner wrench and insert it into end of special cap screw (No. 5) and force the spring and screw up to the threaded end of the plunger (No. 4). Make sure that all parts are aligned and proceed to tighten all parts together. Brush a light coating of grease on the large plunger spring (No. 6) and insert your plunger cap (No. 3) over the spring, Insert socket head cap screws (No. 1) through cap into spacers (No. 2) and tighten socket head cap screws to the valve housing.</p> <p>Step 11: Remove the rod from the tang end of the plungers and rotate the plunger from the tang end, making sure that the plunger turns freely. If plunger should bind, re-adjust special cap screws (No. 1). Holding the cap, insert linkage through tang hole in plunger and move plunger in and out, making sure that the detent action and the spring return is functioning properly. If they do function normally, you know the plunger has been reassembled properly.</p> <p>Step 12: To reset the kickout pressure setting, first install a pressure gage in the cylinder port line, which is in communication with the cylinder port for this plunger. Move the plunger into an operating position and apply pressure at high idle. Adjust in this manner until desired kickout pressure is reached. Never set the plunger kickout pressure higher than the main relief valve pressure setting.</p> |
|---|--|

TROUBLESHOOTING GUIDE FOR GEAR TYPE HYDRAULIC PUMPS

IDENTIFICATION			CAUSE	CORRECTIVE CHECKS
<ol style="list-style-type: none"> 1. Sandblasted band around pressure plate bores 2. Angle groove on face of pressure plate 3. Lube groove enlarged and edges rounded 4. Dull area on shaft at root of tooth 5. Dull finish on shaft in bearing area 6. Sandblasted gear bore in housing 			I. Abrasive wear caused by fine particles. <ol style="list-style-type: none"> 1. Dirt (fine contaminants, not visible to the eye) 	<ol style="list-style-type: none"> 1. Was clean oil used? 2. Was filter element change period correct? 3. Were correct filter elements used? 4. Cylinder rod wiper seals in good condition? 5. Cylinder rods dented or scored? 6. Was system flushed properly after previous failure?
<ol style="list-style-type: none"> 1. Scored pressure plates 2. Scored shafts 3. Scored gear bore 			II. Abrasive wear caused by metal particles <ol style="list-style-type: none"> 1. Metal (coarse) contaminants, visible to the eye 	<ol style="list-style-type: none"> 1. Was system flushed properly after previous failure? 2. Contaminants generated elsewhere in hydraulic system? 3. Contaminants generated by wearing pump components?
<ol style="list-style-type: none"> 1. Any external damage to pump 2. Damage on rear of drive gear and rear pressure plate only 			III. Incorrect Installation	<ol style="list-style-type: none"> 1. Did shaft bottom in mating part? 2. Any interference between pump and machine?
<ol style="list-style-type: none"> 1. Eroded pump housing 2. Eroded pressure plates 			IV. Aeration – Cavitation <ol style="list-style-type: none"> 1. Restricted oil flow to pump inlet 2. Aerated oil 	<ol style="list-style-type: none"> 1. Tank oil level correct? 2. Oil viscosity as recommended? 3. Restriction in pump inlet line? 4. Air leak in pump inlet line? 5. Loose hose or tube connection near or above oil level in tank? 6. Excessive operation of relief valve?
<ol style="list-style-type: none"> 1. Heavy wear on pressure plate 2. Heavy wear on end of gear 			V. Lack of Oil	<ol style="list-style-type: none"> 1. Was oil level correct? 2. Any leaks in piping inside tank? 3. Any oil returning above oil level?
<ol style="list-style-type: none"> 1. Housing scored heavily 2. Inlet peened and battered 3. Foreign object caught in gear teeth 			VI. Damage caused by metal object	<ol style="list-style-type: none"> 1. Metal object left in system during initial assembly or previous repair? 2. Metal object generated by another failure in system?
<ol style="list-style-type: none"> 1. Pressure plate black 2. O-rings and seals brittle 3. Gear and journals black 			VII. Excessive Heat	<ol style="list-style-type: none"> 1. Was a valve stuck? 2. Was relief valve too low? 3. Was oil viscosity correct? 4. Was oil level correct?
<ol style="list-style-type: none"> 1. Broken shaft 2. Broken housing or flange 			VIII. Over Pressure	<ol style="list-style-type: none"> 1. Relief valve setting correct? 2. Did relief valve function?

FIGURE 43

HYDRAULIC PUMP

Disassembly

1. Clean outside of pump thoroughly.
2. Mark the Pump sections on the side nearest to the drive shaft extension so that they can be reassembled back to the original relationship. (Figure 44)

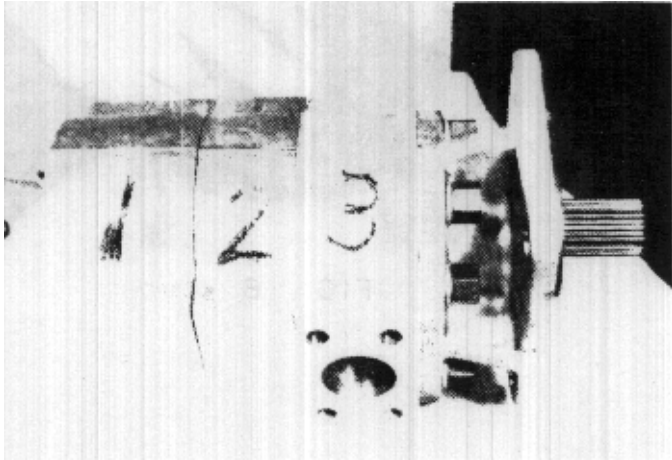

FIGURE 44

3. Place pump in machinist vise securely, shaft up, using a clean block of wood between the flats on each side and the jaws of the vise. This keeps from marring the machined surface of the pump and causing leakage at the port connectors. (Figure 45)

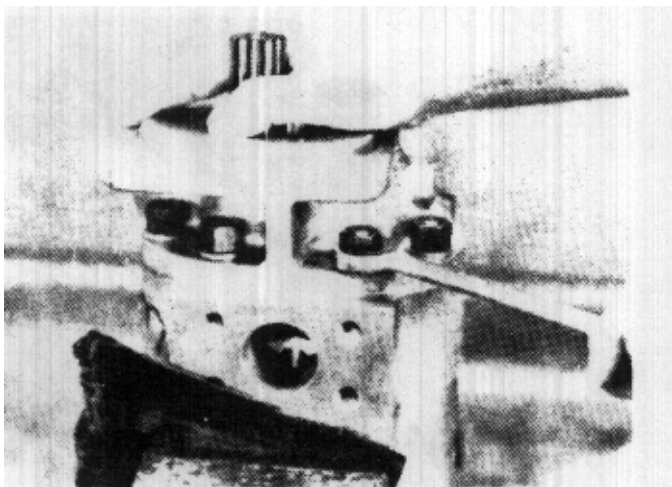

FIGURE 45

4. Remove nuts (23) and washers from studs.

5. Remove pump from vise and set pump on bench with shaft end up. Coat the shaft extension with clean grease. This will help to keep from damaging the rubber sealing surface of shaft seal when seal is removed.

6. Lift the flange (4) off the pump, keeping the flange as straight as possible during removal. If the flange is stuck, use a wood mallet or plastic hammer and tap around the edge to loosen it. (Figure 46)

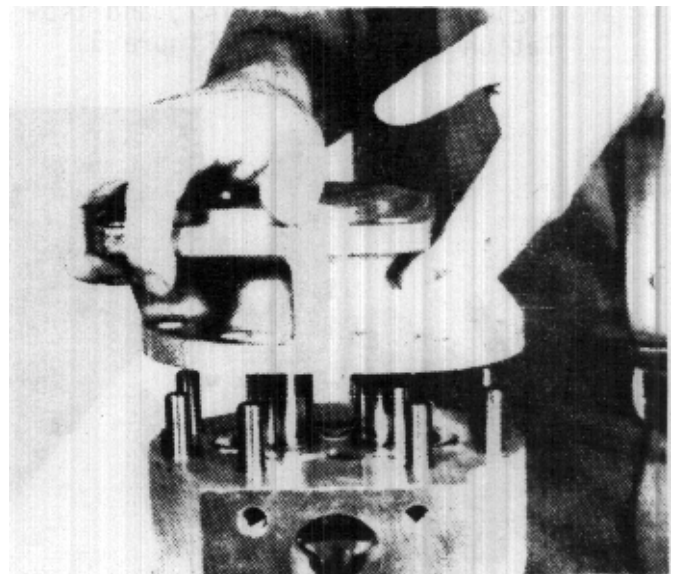

FIGURE 46

- Using vise grip pliers, remove stud bolts (22) from pump. (Figure 47)

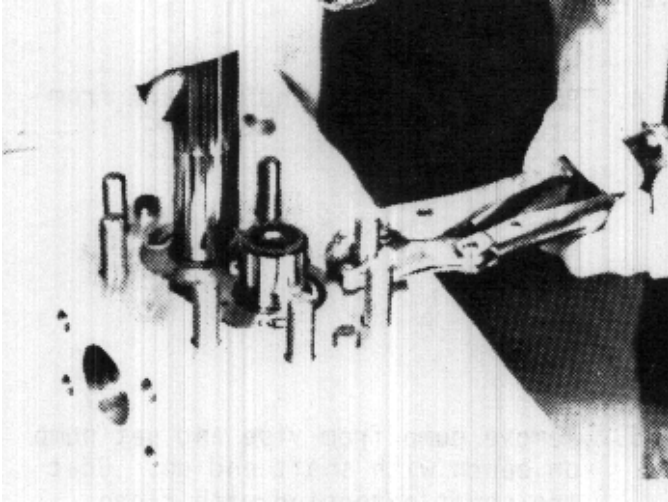

FIGURE 47

- When disassembling the tandem pump, all parts removed with bodies (1 and 2) should be laid out in separate groups.

- Remove ring retainer (13), o-ring (12), back-up ring (14), and isolation plate (10). (Figure 48)

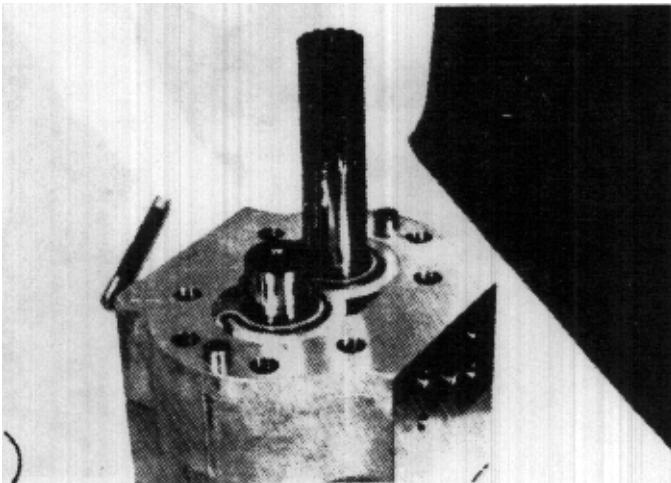

FIGURE 48

- Grasp the drive shaft extension and lift upward to dislodge the pressure plate. Grasp the pressure plate between thumb and forefinger and lift straight up off the shafts. (Figure 49)

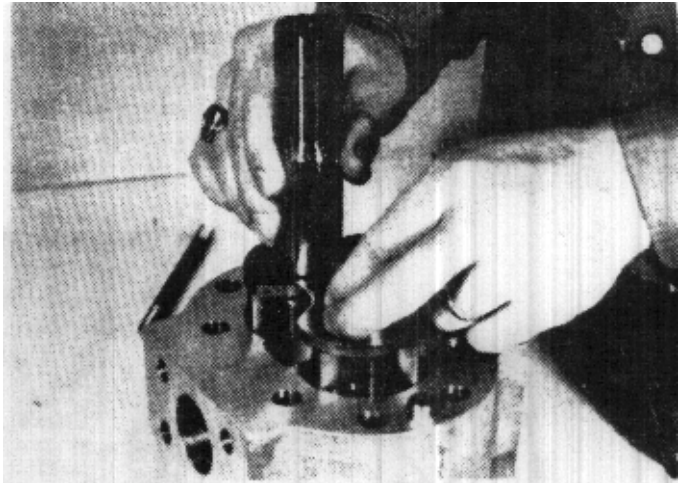

FIGURE 49

- Remove both gears (7 and 5) by lifting them straight up out of the body. (Figure 50).

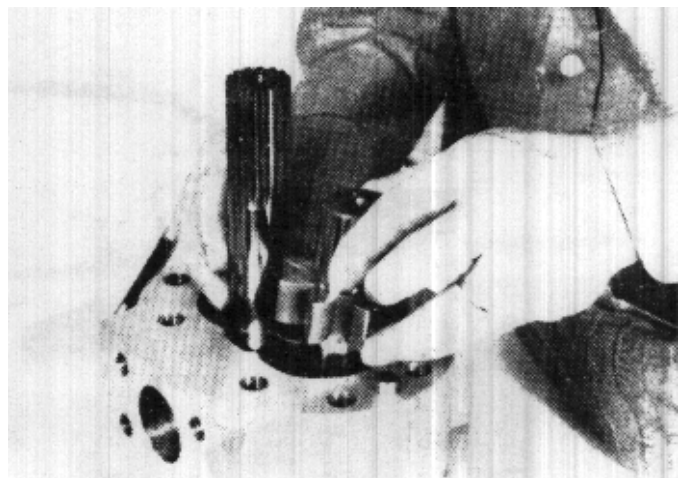

FIGURE 50

12. It will be necessary to remove any burrs from the gear “track-in” in the body (1) before attempting to remove pressure plate (9). After burrs have been removed, the plate can be lifted out. Using thumb and forefinger, lift the pressure plate straight out of the body. Use extreme care in removing this plate as it will bind in the bores of the body if not kept straight during removal (Figure 51).

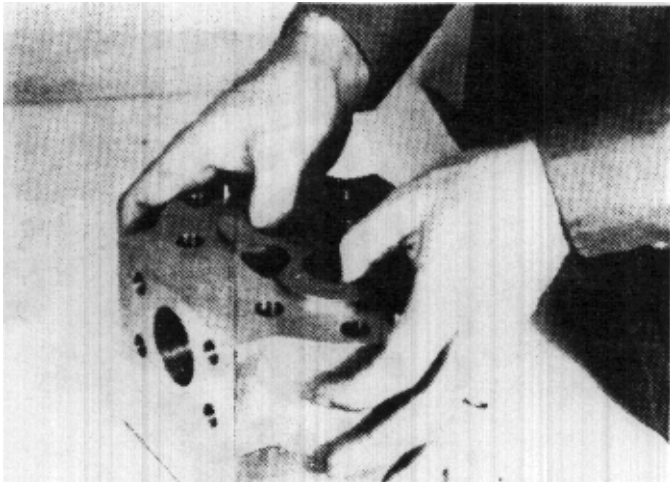

FIGURE 51

13. Remove ring retainer (13), o-ring (12), back-up ring (14), and isolation plate (10).
14. Remove body (1). Using wood mallet or plastic hammer, tap the sides of the body. With the other hand, lift body off dowel pins.
15. Remove spline coupling (16) from drive shaft. (Figure 52)



FIGURE 52

16. Bearing plate (3) can be removed by using method described in Step 14.
17. Disassemble the next section by repeating Steps 8 through 13.
18. Wash all parts of the pump thoroughly with clean solvent and dry with shop air.
19. Inspect all parts to determine which, if any, should be replaced. See Parts Inspection section.

Assembly

20. If Parts 1, 2, 3, and 4 are replaced, examine the new parts and remove any nicks or burrs. flash in clean solvent. Make sure that an identifying mark is put on each new part and on the same side as it was on the old part. Refer to Step 2. This should be done before any parts are assembled.
21. Place the body (2) with its solid flat end down and the mark made in Step 2 facing you.
22. Coat the inside of the body and bearings with clean hydraulic oil. This will insure easier assembly.
23. Out of the group of parts from this pumping section, examine the two isolation plates 10 and 11. You will find that plate 11 has rounded edges. Install this plate on the suction side of the body with the rounded edges down. (Figure 53)

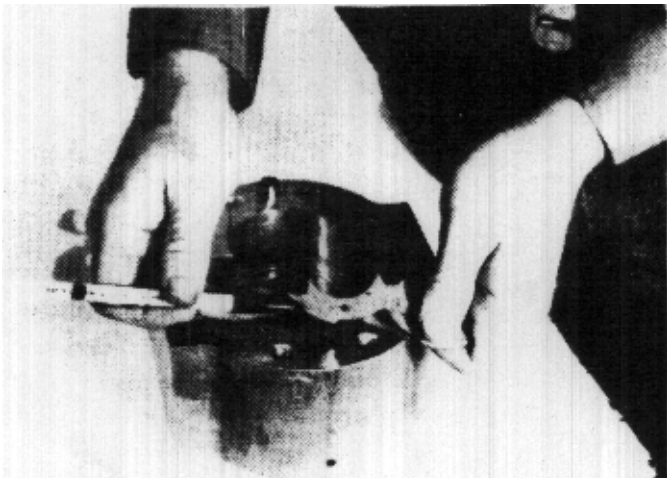

FIGURE 53

24. Install back-up ring (14), o-ring (12), and retainer ring (13). (Figure 54)

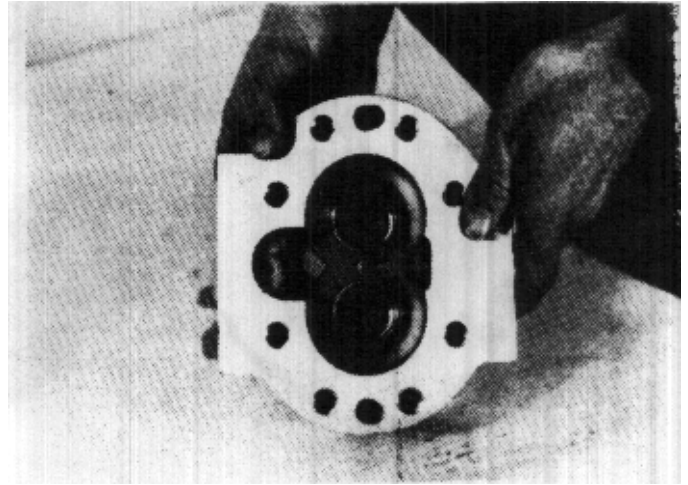

FIGURE 54

25. Pick up a pressure plate, part 9. Use the thumb and forefinger in the hole. Keep the bronze side of the plate facing up and the rounded trap slots facing the discharge side of the pump. Holding the plate as level as possible, slide it into place in the bottom of the body. Do not force the plate into place. If it binds on the way down work it back and forth carefully until it slides into position. (Figure 55)



FIGURE 55

26. Install the drive gear and idler gear. The drive gear should be in the bore nearest the identifying mark made in Step 2, with the splined end up. (Figure 56)

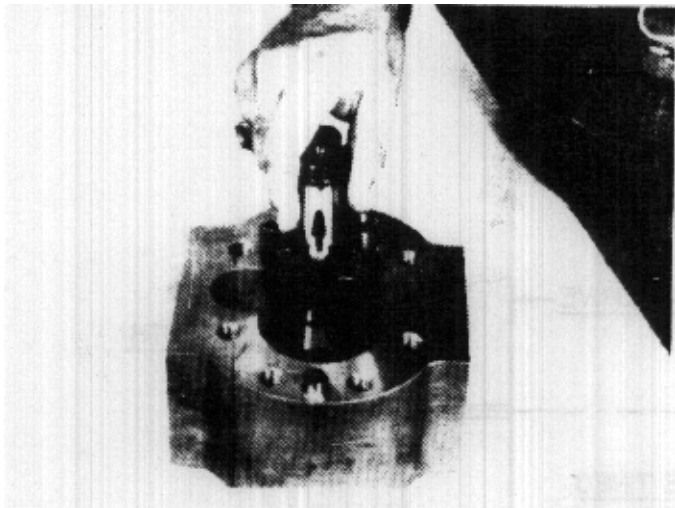

FIGURE 56

27. Install body dowels (20), one near the drive gear and the other near the idler gear.

28. For proper timing of the gears 6 and 8 with gears 5 and 7, see sketch.

29. Install pressure plate (9), bronze side down against the gear faces and with the trap slots facing the discharge side of the body. (Figure 57)

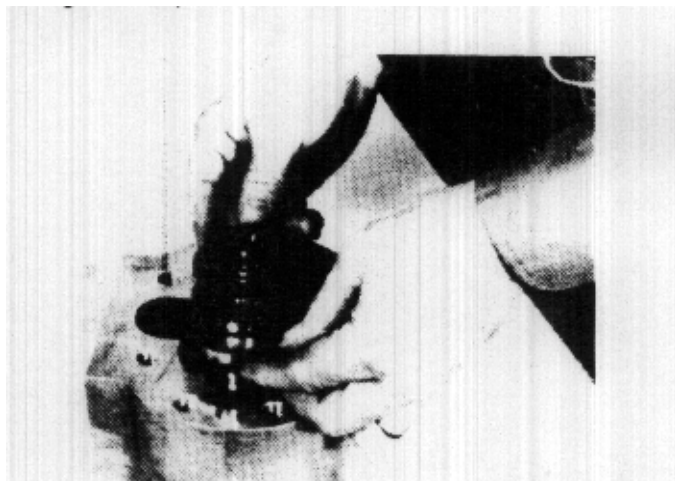

FIGURE 57

30. Install the isolation plate (10) with its square edges on the suction port side. Install back-up ring (14), o-ring (12), and retainer (13) on the discharge side. (Figure 58)

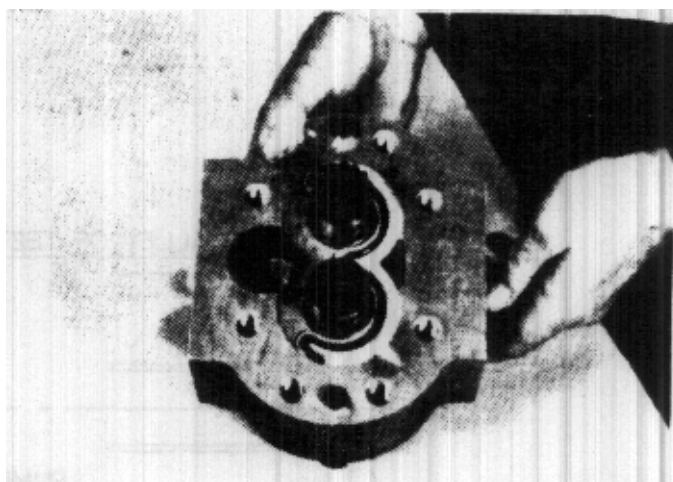

FIGURE 58

31. Install o-ring (25) in the bearing plate (3) on the side which has the bearings extending beyond the plate surface. Use heavy grease to hold the o-ring in position. (Figure 59)

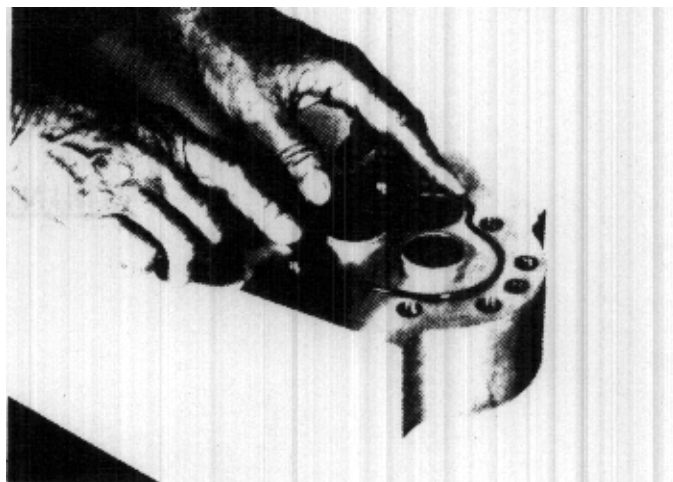

FIGURE 59

32. With the o-ring down, and the identifying mark made in Step 2 facing you, slide the bearing plate (3) down on the shafts until the plate makes contact with the dowels. Use caution and keep the plate level. If the surfaces are not parallel when the bearing enters the back-up ring (14), the bearing will pinch and damage the back-up ring.

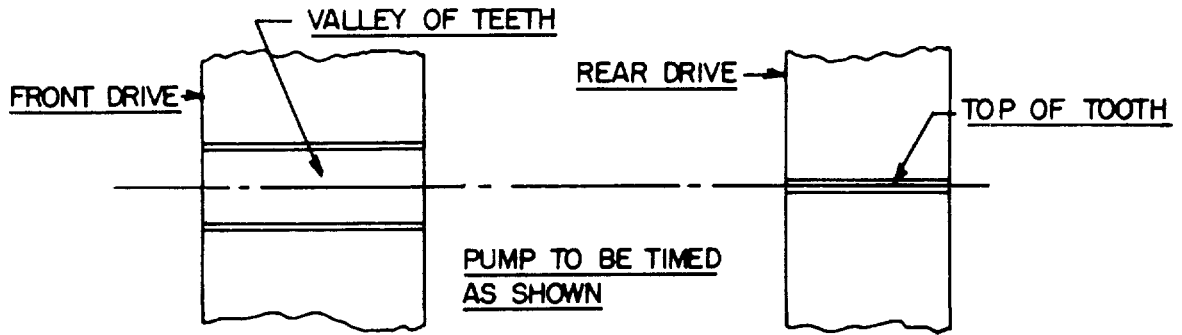

FIGURE 60

**FRONT DRIVE GEAR TO BE TIMED WITH REAR
DRIVE GEAR BY LINING UP A TOOTH ON REAR
DRIVE WITH VALLEY OF TWO TEETH ON FRONT
DRIVE**

TIMING SKETCH

33. Install the spline coupling (16) and O-ring (25). (Figure 61)

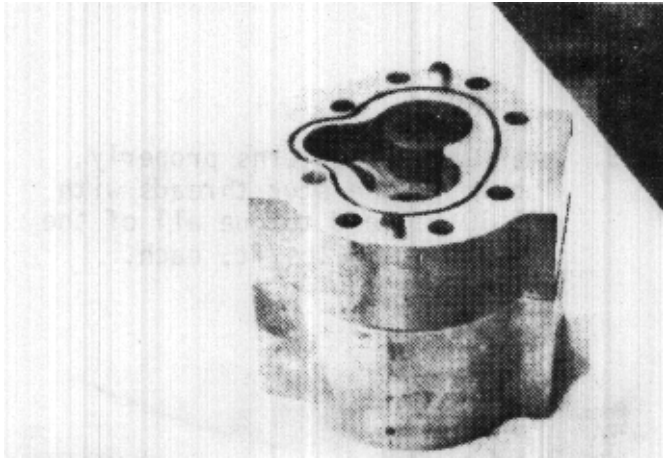

FIGURE 61

38. Install and tighten stud bolts. (Figure 63)

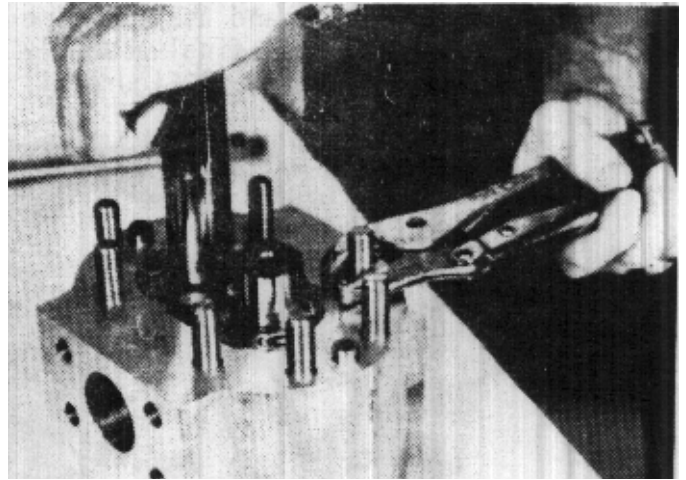

FIGURE 63

34. Install dowels (20).
35. Install body (1) with identifying mark made in Step 2 facing you, and with gear bore up .
36. To assemble this pumping section, repeat Steps 23 through 31, using gears 7 and 5.

37. Install dowels (20) in body (1). (Figure 62)

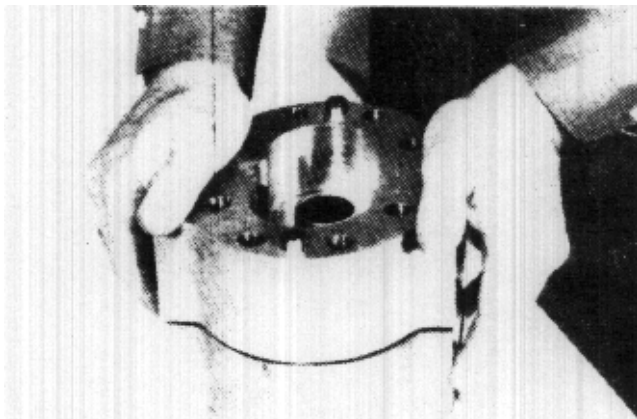

FIGURE 62

39. If a new flange plate (4) is used, plug (27) will have to be pressed into seal drain hole on the discharge side of the flange plate. (Figure 64)

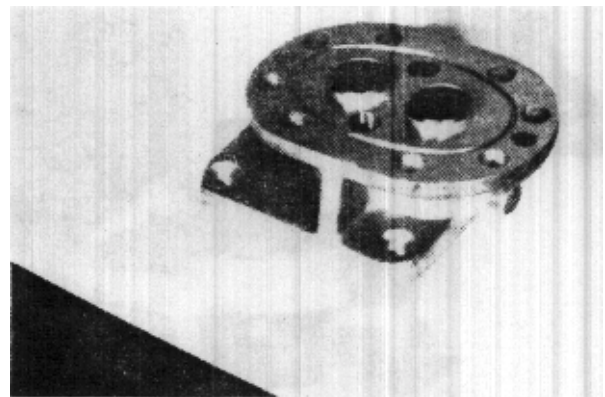

FIGURE 64

40. For seal replacement, refer to seal assembly section in this manual.

41. Install o-ring (24) in the flange plate. Use heavy grease to hold the o-ring in the groove while the plate slides down over the shafts. Refer to Step 32 and use the same precautions in the final assembly of the flange plate. (Figure 65)

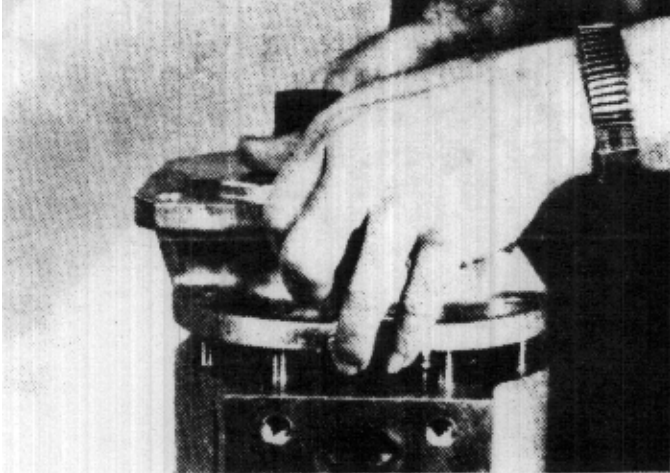

FIGURE 65

42. Install washers (26) and nuts (23). Tighten two opposite nuts. Use a 10" wrench to check the shaft for binding. It should turn with 5 to 7 pounds-feet of torque applied. (Figure 66)

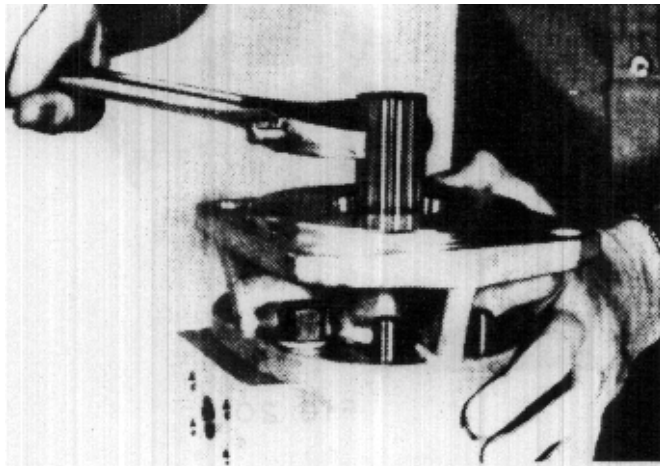

FIGURE 66

43. If the shaft will not turn properly, disassemble the pump and examine it for burrs or foreign material causing build-up or interference with the parts. Also check for the isolation plate with the radius edge not being in the bottom of the gear bore.

44. Correct the cause of interference and reassemble the pump.

45. When the shaft turns properly, lubricate the stud threads with SAE 10 oil and torque all of the nuts 80 to 90 lbs/ft. each. (Figure 67)

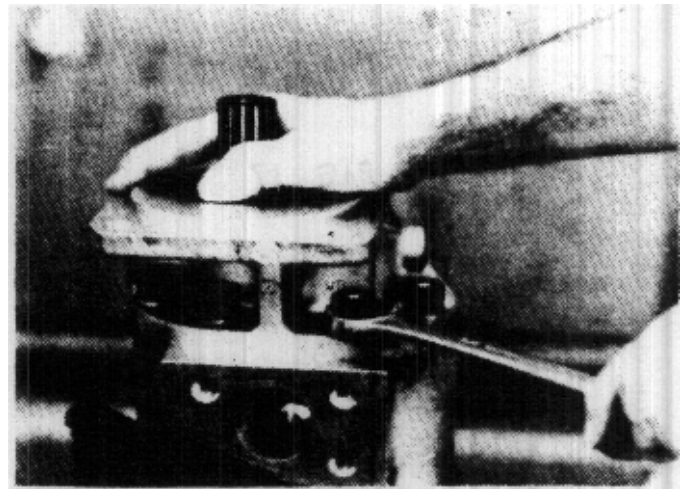

FIGURE 67

Seal Replacement

1. Stand pump on end and loosen all fasteners holding flange to body. Remove flange.
2. Lay the flange on a smooth clean surface and remove snap ring.

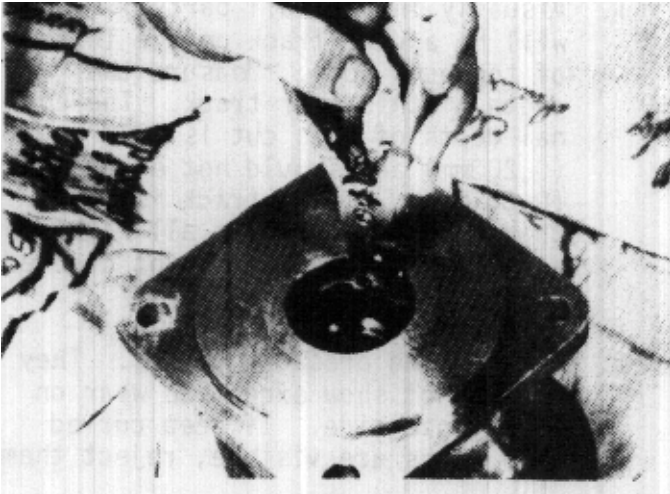

FIGURE 68

3. Lay flange on open jaws of vise (pilot down), using punch and mallet tap old seal out of the bore. Caution must be taken not to scar the seal bore in the flange. Drive the seal out straight by moving the punch around the seal as it is driven out. (Fig. 69)

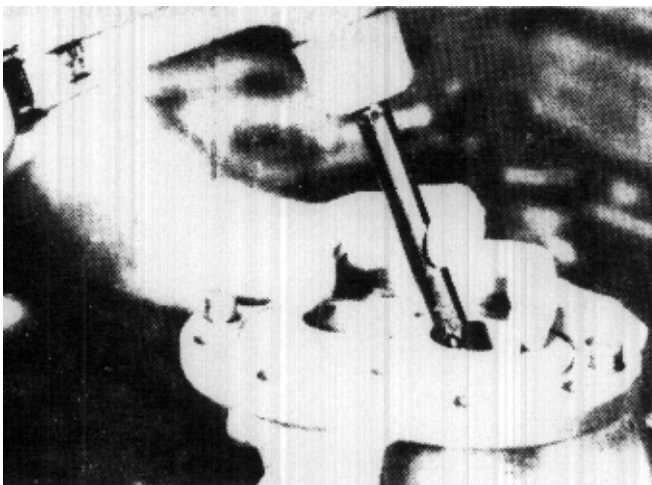

FIGURE 69

4. The rubber lip of the seal should point toward the rear of the pump so that the garter spring is inside. (Fig. 70)

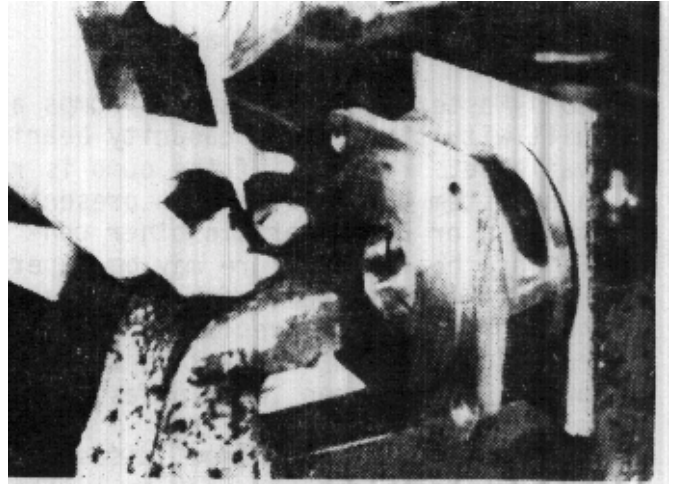

FIGURE 70

5. Place a clean block of wood between the rear jaw of the vise and the back of the flange. Next, place the seal in position in the bore of the flange.
6. Place the seal press ring in position against the seal, taking care that it is centered over the seal. (Fig. 71)

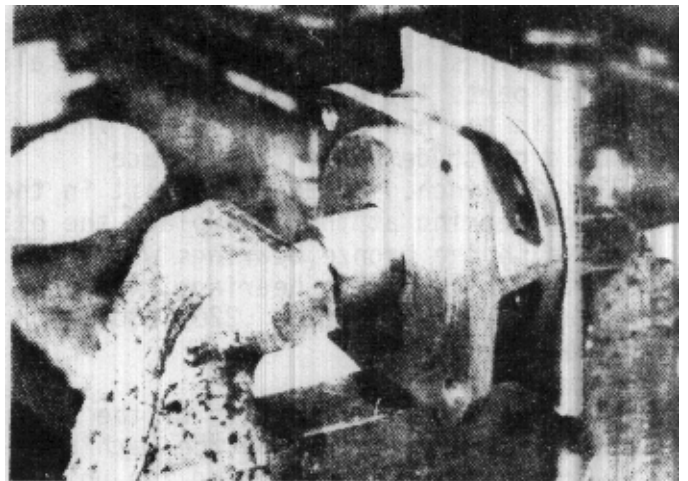

FIGURE 71

7. By tightening the vise firmly, but gently, press the seal into the bore.
8. Stop the pressure when the seal touches the shoulder inside the bore.
9. Replace snap ring, making sure that it snaps into the groove properly.

Wash the flange thoroughly in solvent. Coat the lips of the seal with heavy grease.

Bearing Replacement

Mobil-Master Series 20 and 25 pumps are built with the highest capacity bearings available. However, if the pump is run on a system with contaminant present in the oil, or under certain other conditions, bearing failure may be experienced. In the event of bearing failure the bearings may be replaced if the gears have not cut a track in the housing deeper than .015 inches.

To remove the old bearings, disassemble the pump and place the body in a vise. Clamp on the side of the body using cardboard to prevent marring by the vise jaws.

Using the small keyhole type hack saw, cut through the bearing opposite the oil groove. Be sure the saw cuts completely through the bearing shell, but cuts as little as possible into the aluminum bore.

After the cut is made, grip the bearing with vise-grip pliers and remove it with a twisting motion. Flange bearings can be removed in the same manner. Take care not to damage the bores. After the old bearings have been removed, wash all of the parts thoroughly in solvent. Press in the new body bearings. They should protrude above the surface .220/.230 inch. Locate the split in the flange bearing at the same place the oil groove in the bronze bearings was located. The flange bearings, when replaced, must protrude .220/.230 inch above the surface.

Install the remaining parts of the repair kit and replace on the machine. No break-in is necessary and the unit is ready to operate at full capacity.

Inspection of Parts

1. Visually inspect all parts. There will be a gear track on the inside of the pump body. Measure the depth of this gear track. The nominal depth of this cut is .008" (0,203 mm) and should not exceed .015" (0,381 mm). If the track is less than .015, the body is all right for assembly provided it is not cracked or damaged otherwise.
2. Examine the pressure plates. They should not show excessive wear on the bronze side. If deep curved wear marks are visible, reject them.
3. Examine the gears. If excessive wear is visible on the journals, sides or face of the gears, or at the point where it rotates in the seal, reject them.
4. If any of the internal parts show excessive wear, replace all the parts
5. For further information on inspection of parts, see PUMP TROUBLESHOOTING GUIDE, or DIAGNOSING TYRONE GEAR PUMP FAILURES.

REAR DRIVE MOTOR

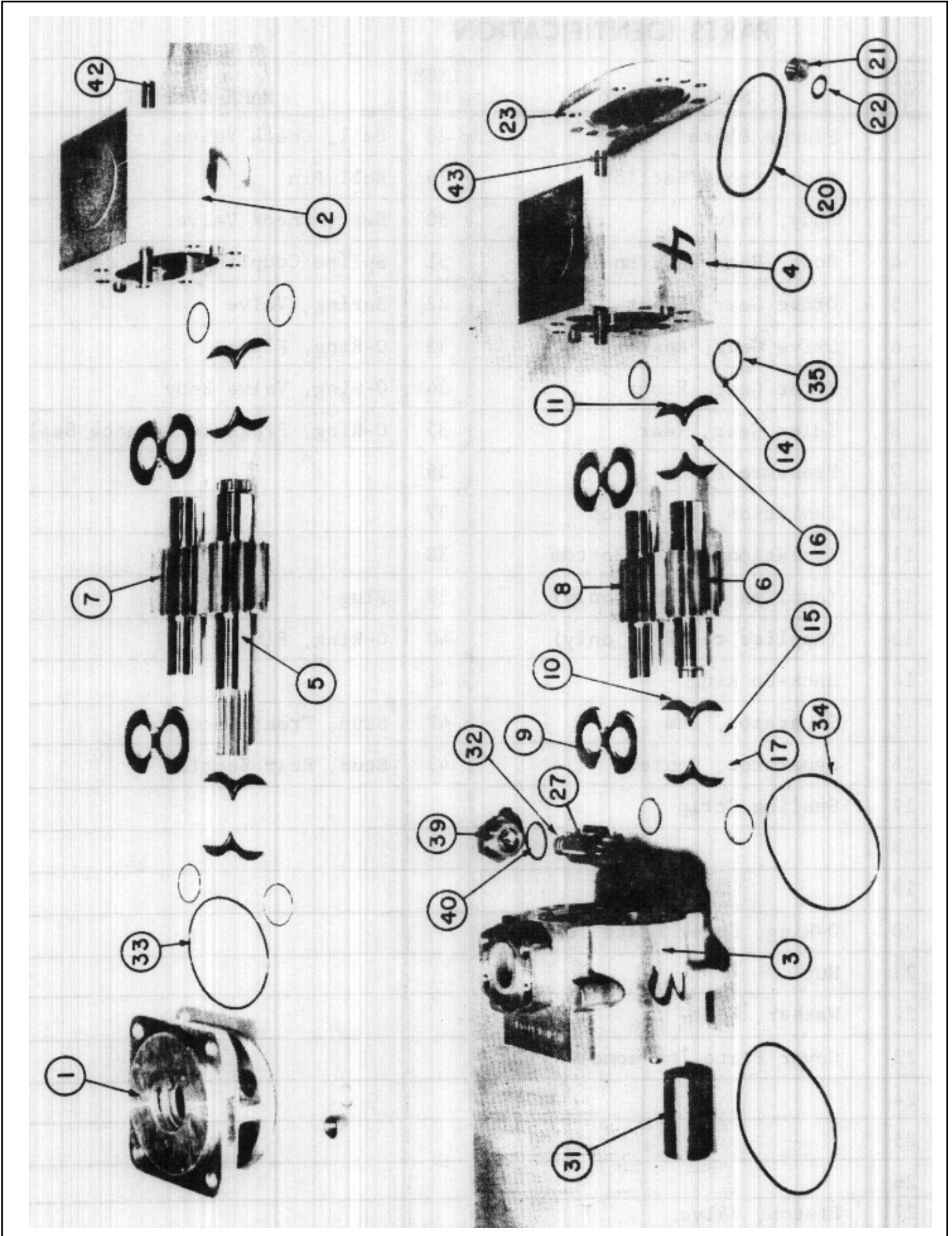

FIGURE 72

PARTS IDENTIFICATION

ITEM NO.	NAME OF PART	ITEM NO.	NAME OF PART
1	Flange Plate	28	Ball, Check Valve
2	Body, Front Section	29	Roll Pin
3	Body, Valve	30	Seat, Check Valve
4	Body, Rear Section	31	Spline Coupling
5	Drive Gear, Front	32	Spring, Valve
6	Drive Gear, Rear	33	O-Ring, Flange
7	Idler Gear, Front	34	O-Ring, Valve Body
8	Idler Gear, Rear	35	O-Ring, Pressure Balance Seal
9	Pressure Plate	36	
10	Isolation Plate, Top	37	
11	Isolation Plate, Bottom	38	
12	(Applies to SPM25 only)	39	Plug
13	(Applies to SPM25 only)	40	O-Ring, Plug
14	Back-Up Ring	41	
15	Separator, End	42	Stud, Front Section
16	Separator, Center	43	Stud, Rear Section
17	Sealing Strip		
18			
19			
20	O-Ring, Cover Plate (on some)		
21	Nut		
22	Washer, Flat		
23	Cover Plate (on some)		
24			
25			
26			
27	Piston, Valve		

FIGURE 73

DISASSEMBLY

1. Clean the outside of the motor thoroughly.
2. Mark the motor sections on the drive shaft extension side so that they can be reassembled exactly in the same order as they were originally. (Fig. 74)

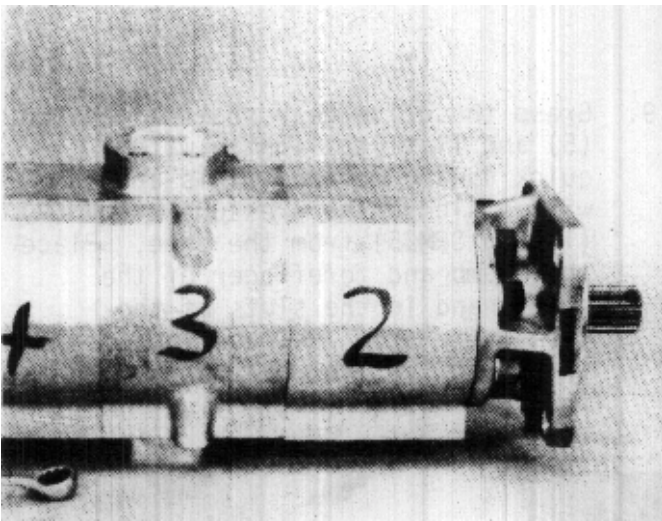

FIGURE 74

3. Securely fasten the motor in a machinist's vise, shaft up. Use a cream block of wood between each flat side of the motor and the vise jaws. This will protect the machined surfaces from damage which would cause leakage at port connectors. (Fig. 75)

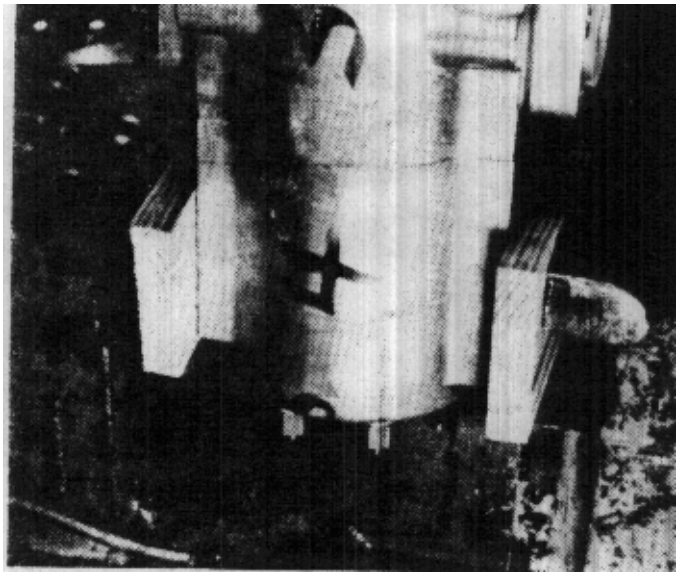

FIGURE 75

4. Remove nuts (21) and washers (22) from the flange. (Fig. 76)

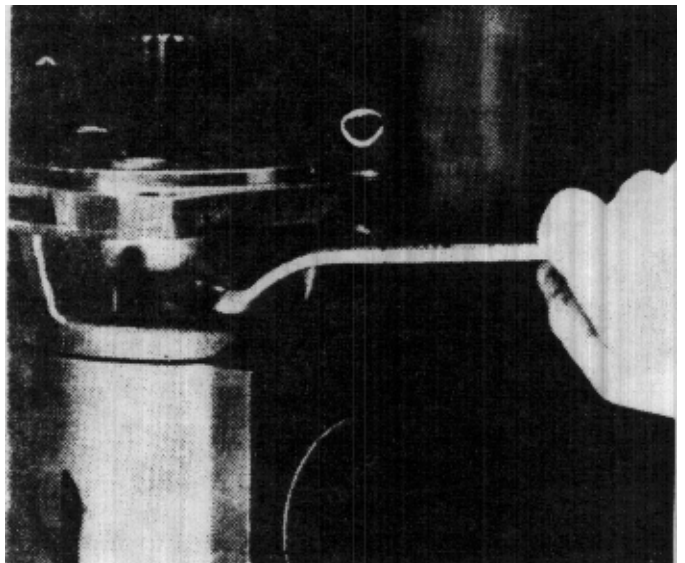

FIGURE 76

5. Keeping the flange (1) as straight as possible, lift it off the shaft and stud bolts. If the flange is stuck, use a wooden mallet or plastic hammer and tap around the edge to loosen it. (Fig. 77)

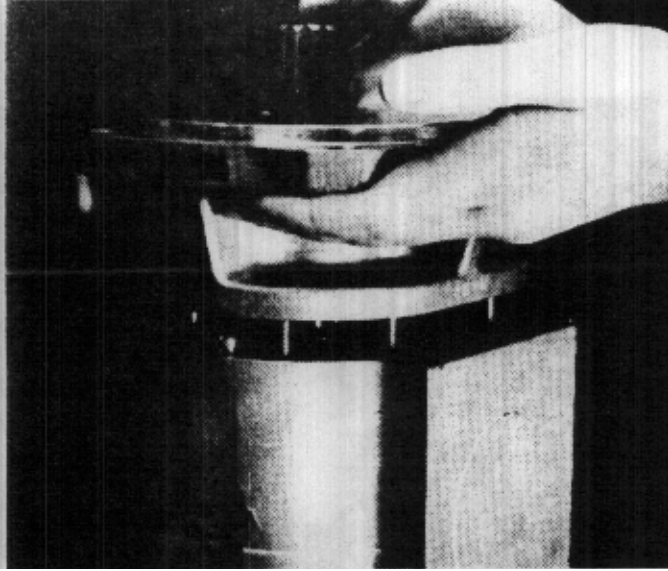

FIGURE 77

6. Remove o-ring (33) from the flange.
7. Remove isolation plates (10), sealing strips (17), end separators (15), center separators (16), back-up ring (14), and o-ring (35). (No isolation plates nor separators in SPM25.) (Fig. 78)

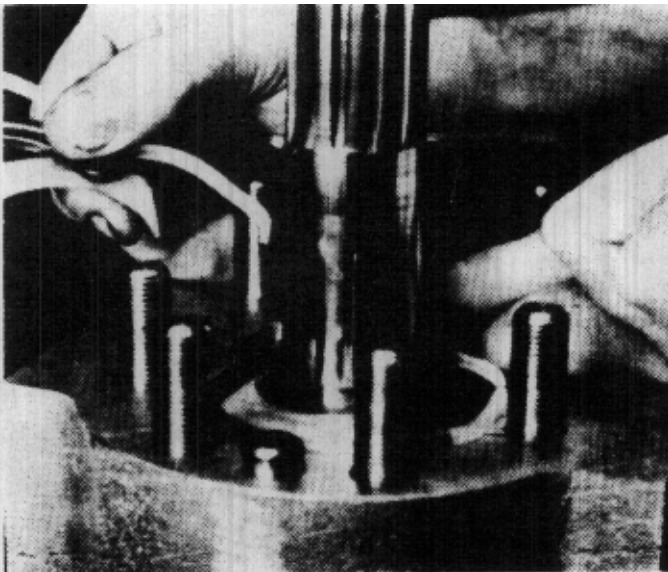

FIGURE 78

8. Use a stud driver or vise-grip pliers and remove studs (42). (Fig. 79)

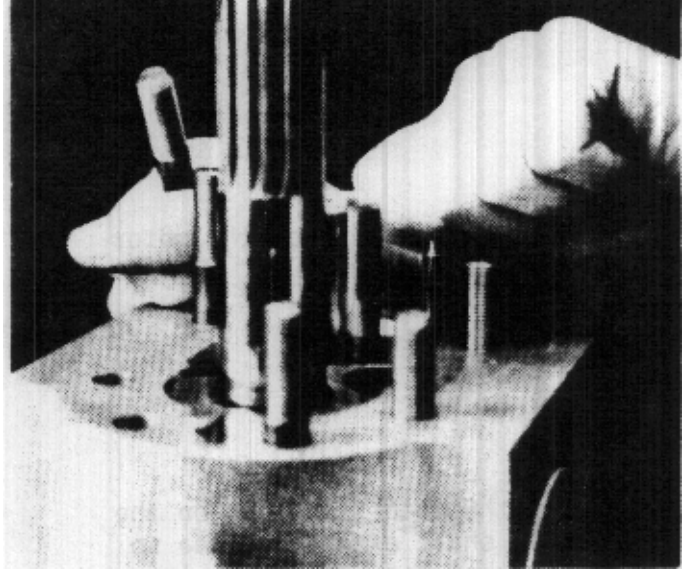

FIGURE 79

9. Grasp the drive gear shaft extension (5) and lift it slightly with a quick upward motion. This action will dislodge the pressure plate (9) (12, in SPM25) from the bore. Place the thumb and forefinger of the other hand in the slots of the pressure plate. Release the drive shaft and lift the pressure plate from the body. (Fig. 80)

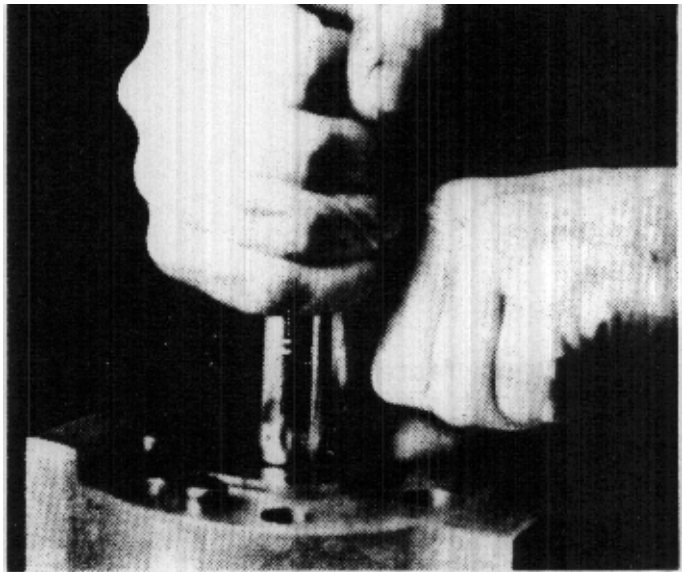

FIGURE 80

10. Lift drive gear (5) and idler gear (7) straight up out of the motor body. (Fig. 81)

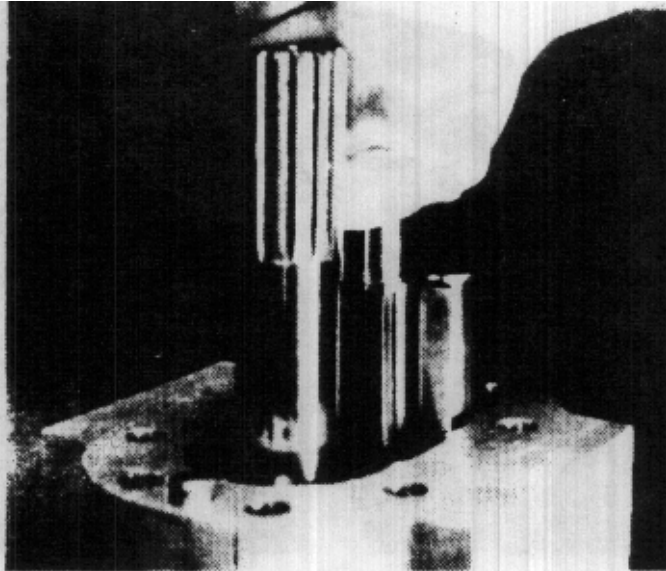

FIGURE 81

11. To remove the bottom pressure plate (9) (13, in SPM25) from the motor body, use an adjustable sleeve bearing puller. (A puller of this type is listed in McMasters and Carr's catalog under part number 6354N14). Insert the puller in the pressure plate bore. With a very light rocking motion applied to the puller handle, unseat the plate. Lift it straight up and out of the motor body. Use extreme care in the removal of this plate. Do not attempt to pry or force it. (Fig. 82)

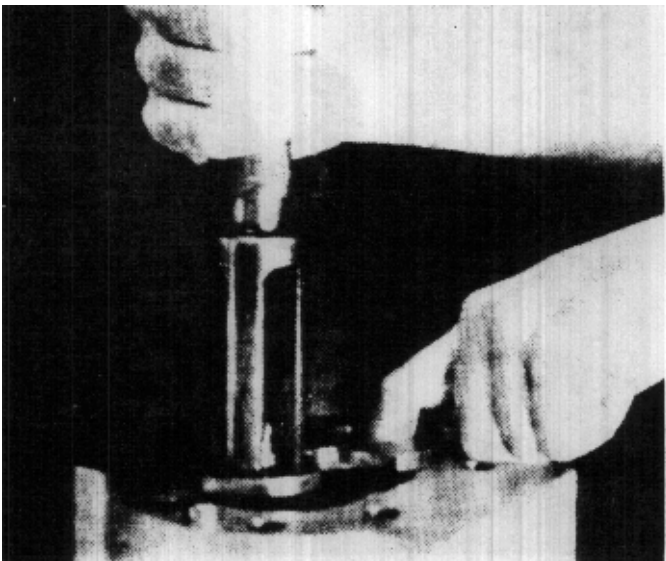

FIGURE 82

12. Remove isolation plate (11), sealing strip (17), end separators (15) center separator (16), back-up ring (14), and o-ring (35). (No isolation plates nor separators in SPM25.)
13. Remove the body (2) by lightly tapping the sides with a wooden mallet or plastic hammer, while lifting it with the other hand. Remove o-ring (34). (Fig. 83)

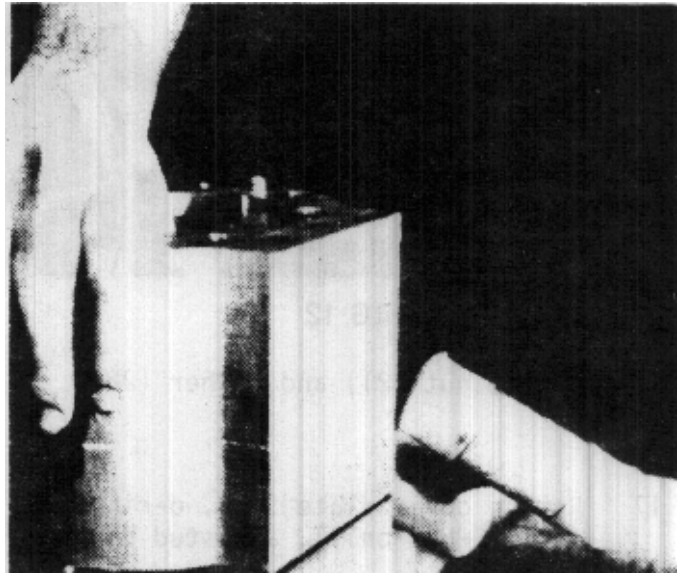

FIGURE 83

14. Remove the spline coupling (31). (Fig. 84)

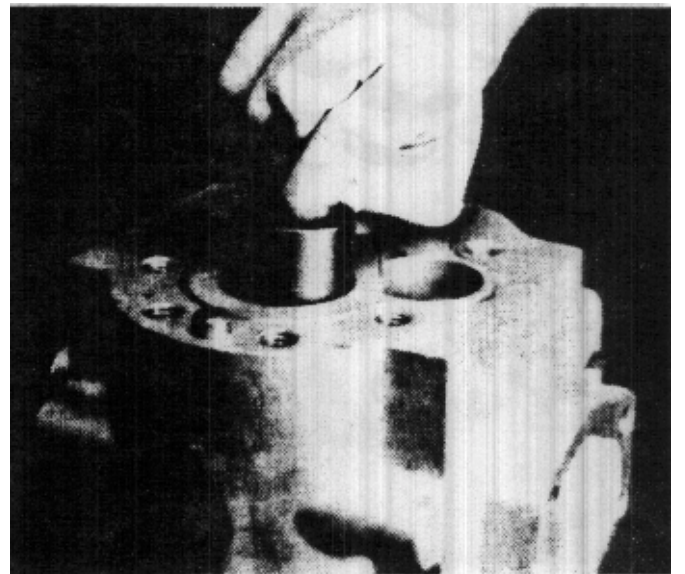

FIGURE 84

15. To disassemble the rear section, it will be necessary to reverse its position in the vise (rear end up). (Fig. 85)

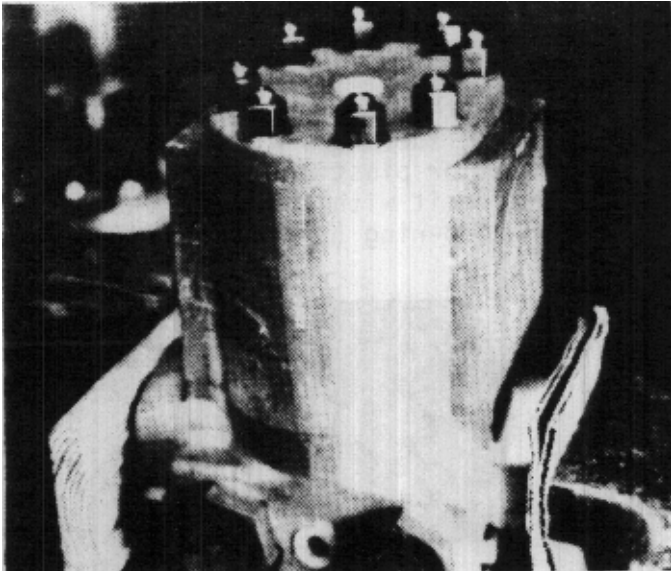

FIGURE 85

16. Remove nut (21) and washer (22).
17. Remove cover plate (23), o-ring (20) (some SPM20 only), and stud bolts (43)
18. Now remove the assembly from the vise and set it on a clean bench with the valve body (3) up. (Fig. 86)

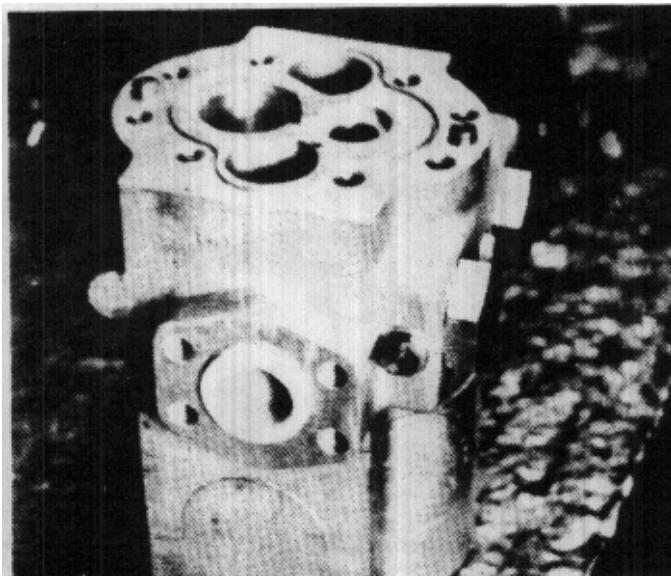

FIGURE 86

19. Remove the valve body by tapping lightly on the plugs (39) with a soft hammer. (Fig 87)

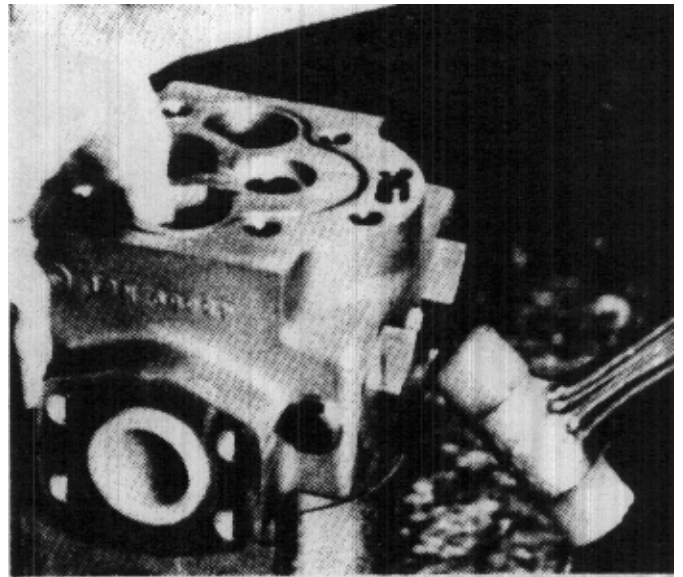

FIGURE 87

20. Remove o-ring (34).
21. To disassemble the rear motor sections, repeat Steps 7 through 12, as applicable. Keep these parts separate from the front motor. Although most of the parts are interchangeable, the body and gears may not be. (Fig. 88)

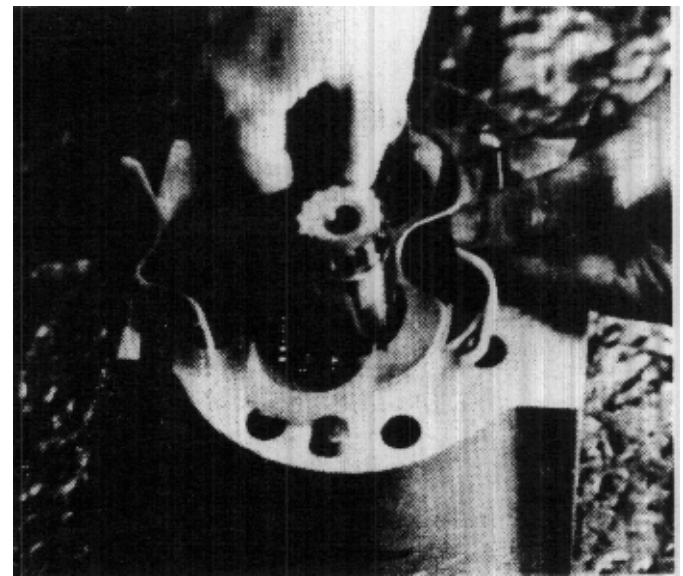

FIGURE 88

22. To disassemble the valve from the valve body, remove plug (39) and o-ring (40). (Fig. 16)

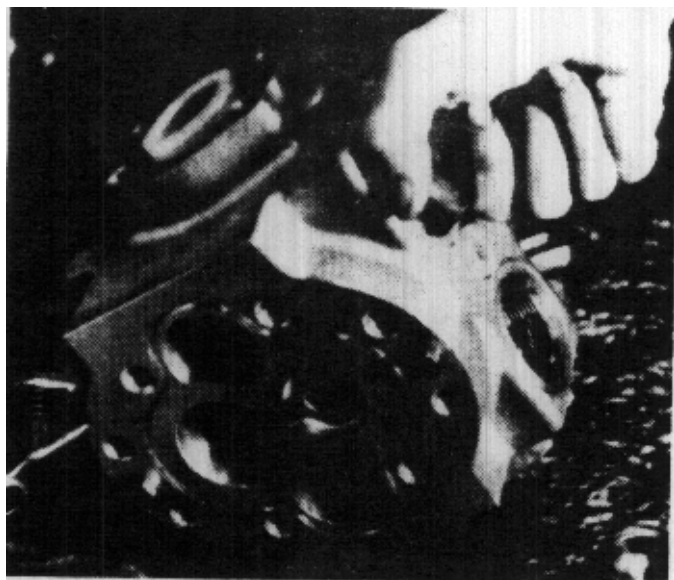

FIGURE 89

24. Items (28) and (30) are not serviceable separate from valve body (3).

25. Wash all of the motor parts thoroughly with clean solvent and blow them dry with compressed air. This action should remove any foreign matter trapped in the motor.

26. Inspect the parts carefully. For detailed instructions, see "Inspection of Parts" section.

23. Remove spring (32) and piston (27). (Fig. 90)

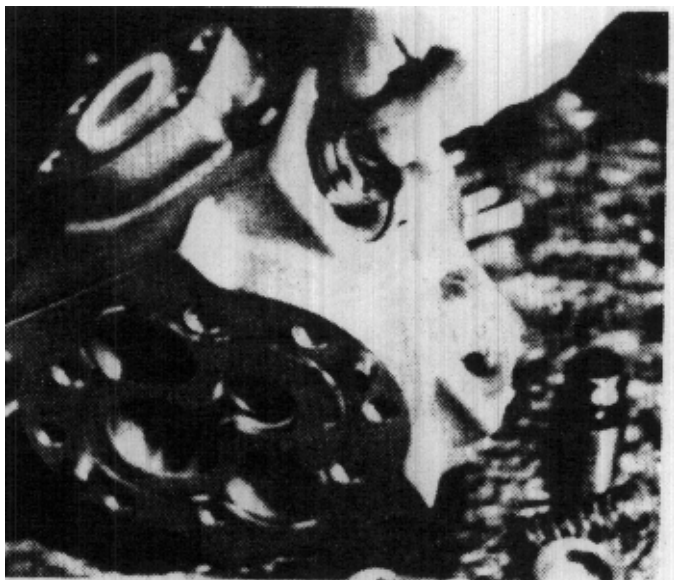

FIGURE 90

27. Take cover plate (23) and place it on a clean flat surface with the o-ring groove facing up. Install o-ring (20). (SPM20 only)

28. Place the motor body (4) on the cover plate (SPM20) with the gear bore facing up. Make sure that the mark made in, Step 2 is facing you. (If a new body is used, it does not matter which way the body faces.) (Fig. 91)

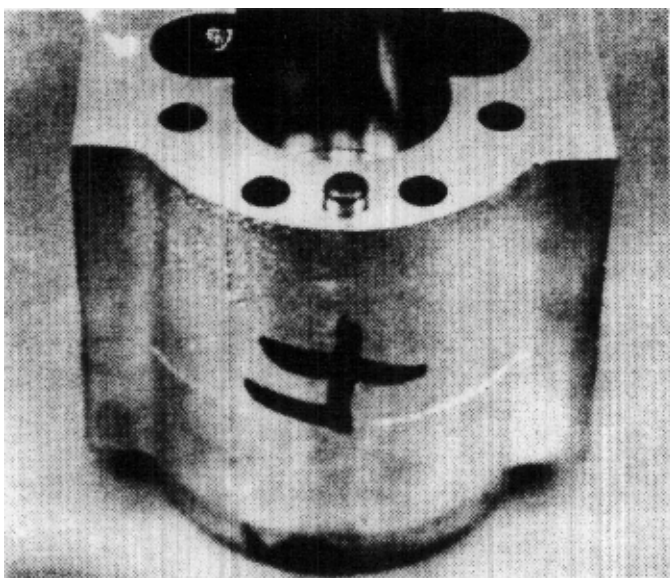

FIGURE 91

29. Install the o-rings (35), then the back-up rings (14 on the bearings which extend up from the bottom of the body. (Fig. 92)

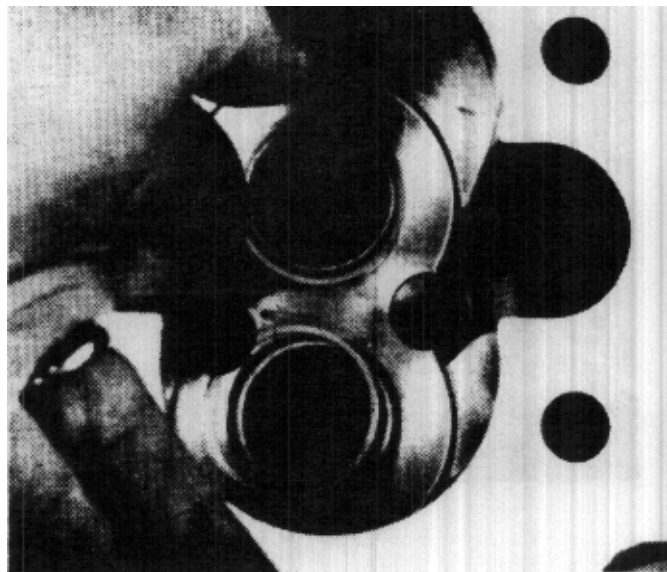

FIGURE 92

30. Install center separator (16), end separator (15) and sealing strip (17). (No separators in SPM25) (Fig. 93)

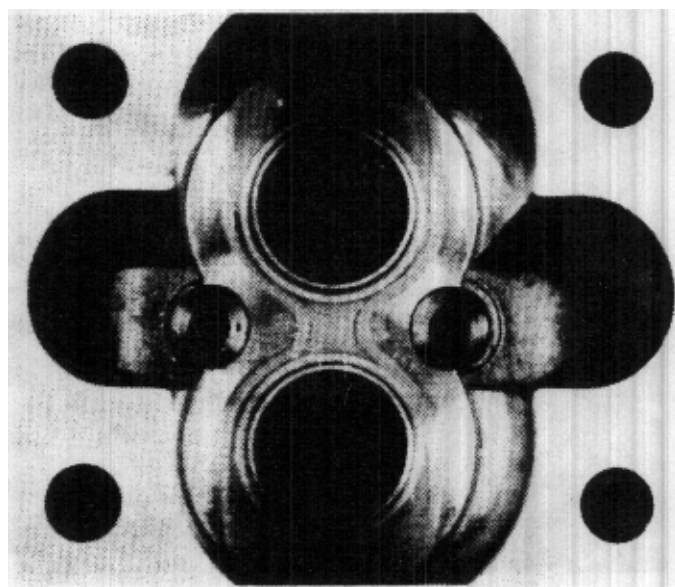

FIGURE 93

31. Examine the isolation plates. You will note that they are slightly different. Choose the two having rounded edges as shown. Install these two (11) in the bottom of the motor body with the rounded edges down and in their proper location. (No isolation plates in SPM25.) (Fig. 94)

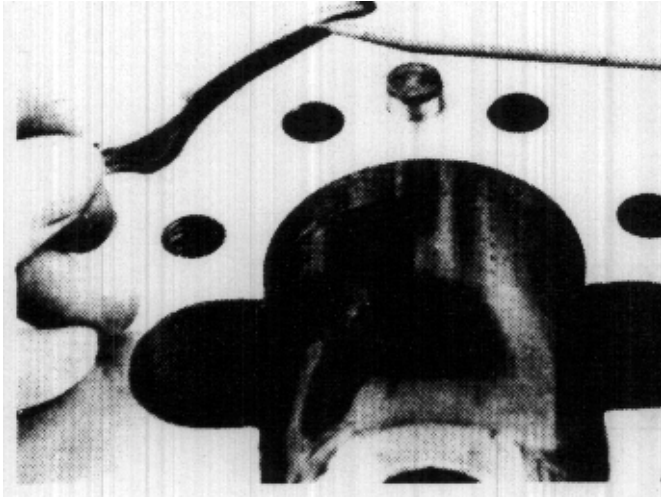

FIGURE 94

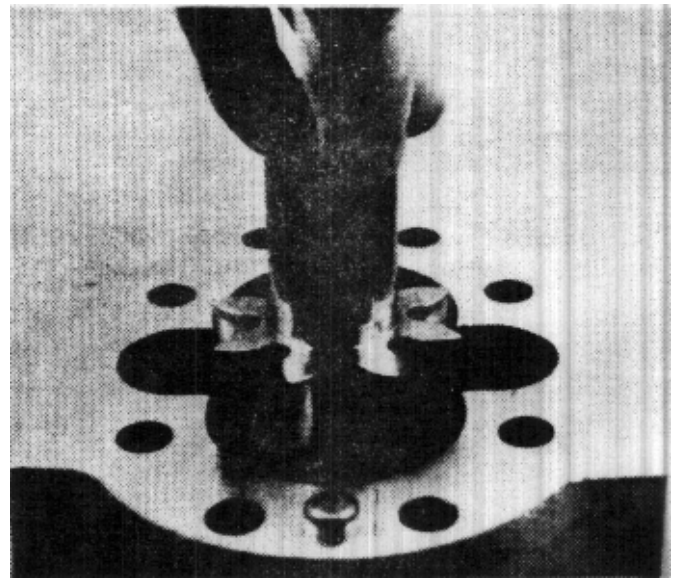

FIGURE 95

34. Coat the idler gear (8) journals with clean hydraulic oil and install it in the opposite bore. (Fig. 96)

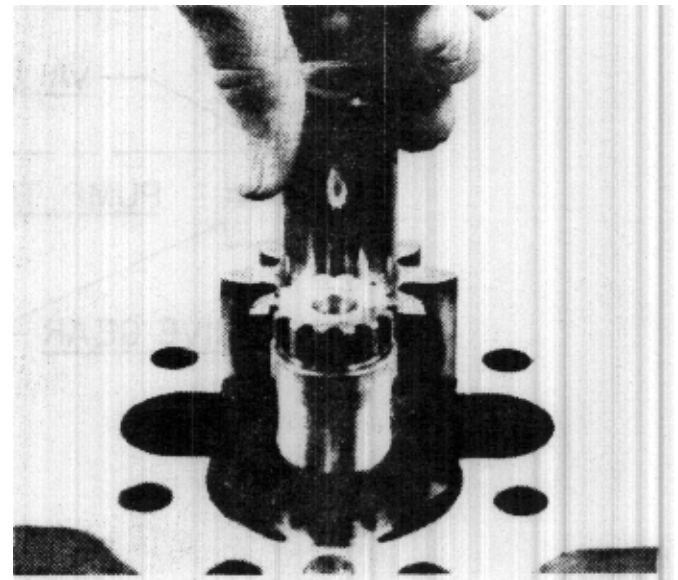

FIGURE 96

32. Install pressure plate (9) (13, in SPM25) with the bronze side up. Keep the plate as level as possible and slide it down to the bottom of the body. DO NOT FORCE THE PLATE.

33. Coat the journals of drive gear (6) with clean hydraulic oil and with the splined end up, insert it into the bore nearest you. DO NOT DROP IT INTO PLACE. Slide it into place gently. Dropping it will damage the bronze face of the pressure plate. (Fig. 95)

35. Before continuing to assemble the motor, it will be necessary at this point to position the drive gear in this section for proper timing as shown in Sketch 'A'.
36. Install top pressure plate (9) (12, in SPM25) with the bronze side down.

FRONT DRIVE TO BE TIMED WITH
REAR DRIVE BY LINING UP A
TOOTH ON REAR DRIVE WITH
VALLEY OF TWO TEETH ON
FRONT DRIVE

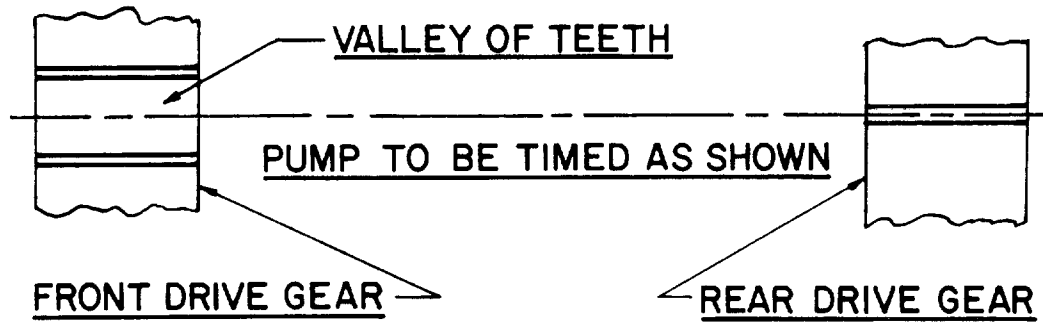

FIGURE 97

SKETCH 'A'

37. Install center separator (16), end separators (15), sealing strip (17), and isolation plates (10). (No separators nor isolation plates in SPM25.) (Fig. 98)

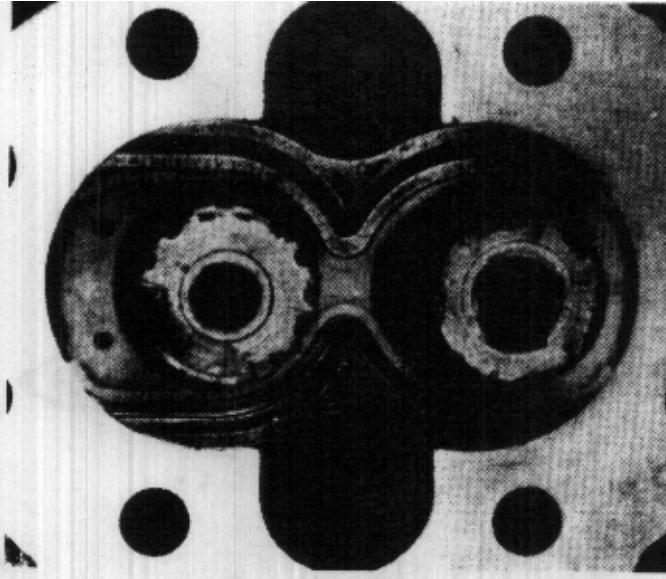

FIGURE 98

39. Pick up valve body (3). Turn it so that the side which has the bearings extended will face up. Apply enough clean, heavy grease in the o-ring groove to hold the o-ring in place after the plate has been turned over. Install o-ring (34). Install an o-ring (35) down on each protruding end of the bearings. (Fig. 100)

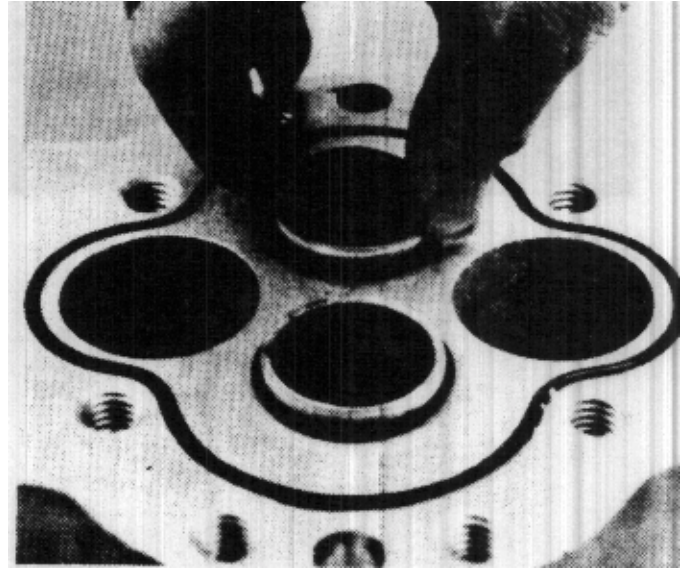

FIGURE 100

38. Place a back-up ring (14) on each shaft and seat the rings carefully against the pressure plate. (Fig. 99)

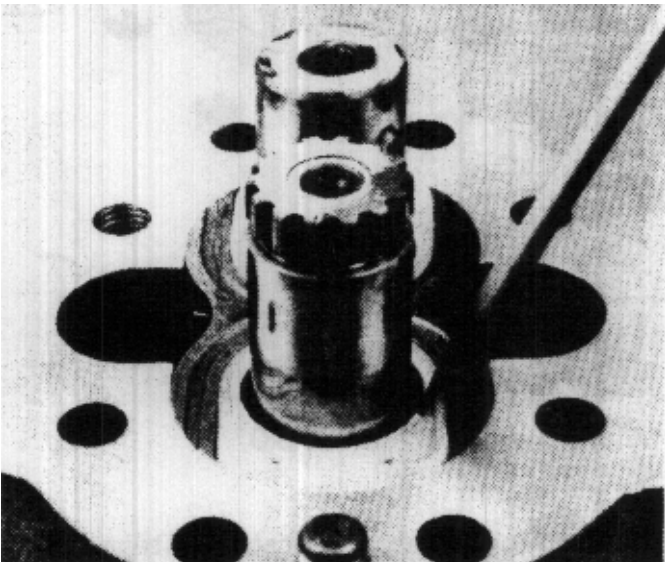

FIGURE 99

40. With the mark made in Step 2 facing you and the o-ring facing down, the shaft until it makes contact with the dowels. Caution should be used from this point on to prevent the bearings from pinching or upsetting the back-up rings as the body is lowered onto the dowels. (Fig. 101)

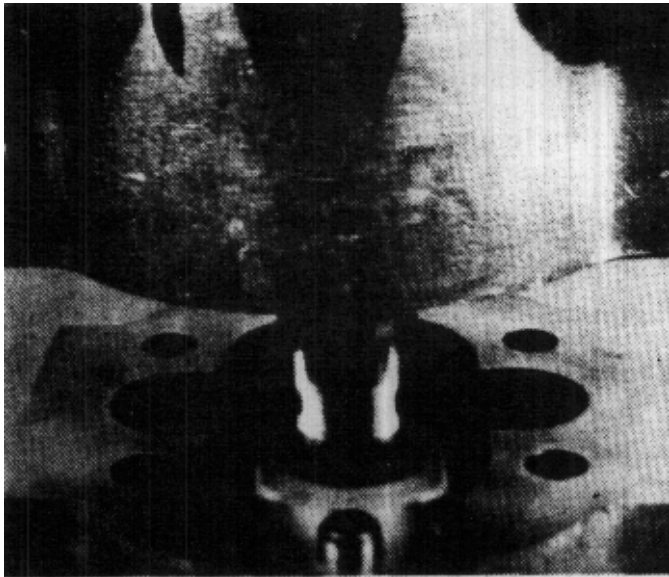

FIGURE 101

42. Position the assembly with the valve body up and install o-ring (34) and spline coupling (31). Make sure the gears are not turned from the timing position until after the other set of gears has been assembled. (Fig. 103)

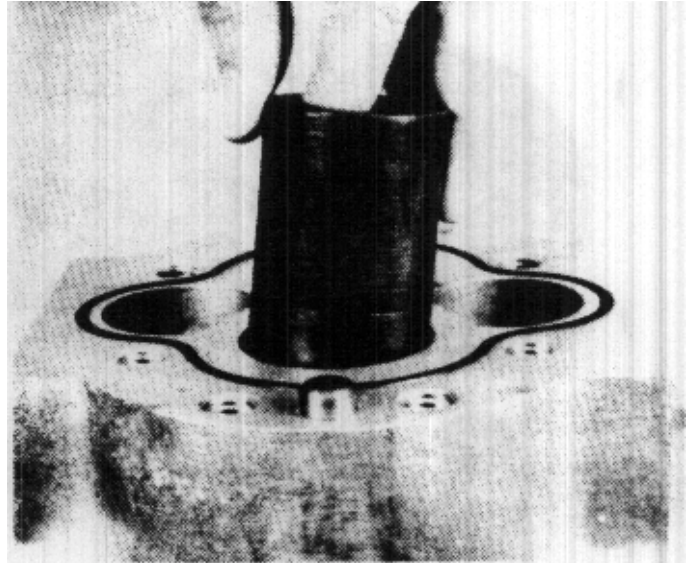

FIGURE 103

41. Lay the partially assembled unit on its side and install studs (43), washers (22) and nuts (21). You can wait until the motor is completely assembled before applying final torque to these studs. (Fig. 102)

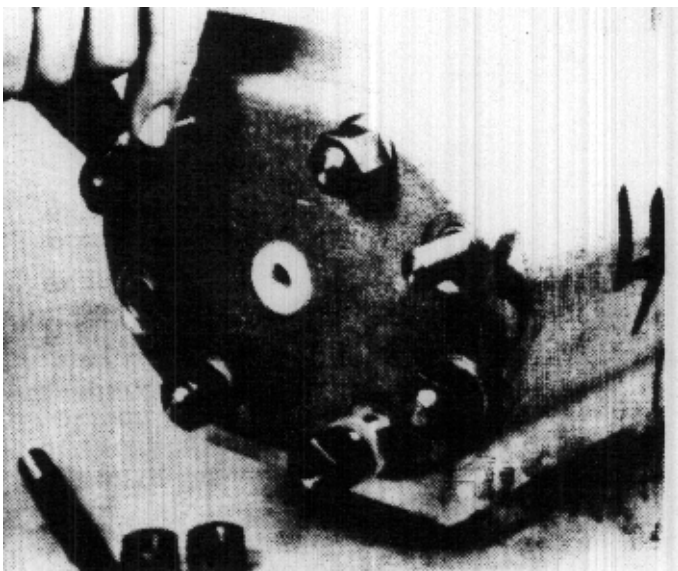

FIGURE 102

43. Install motor body (2) with the mark that was made in Step 2 facing you and with the gear bore facing up. (Fig. 104)

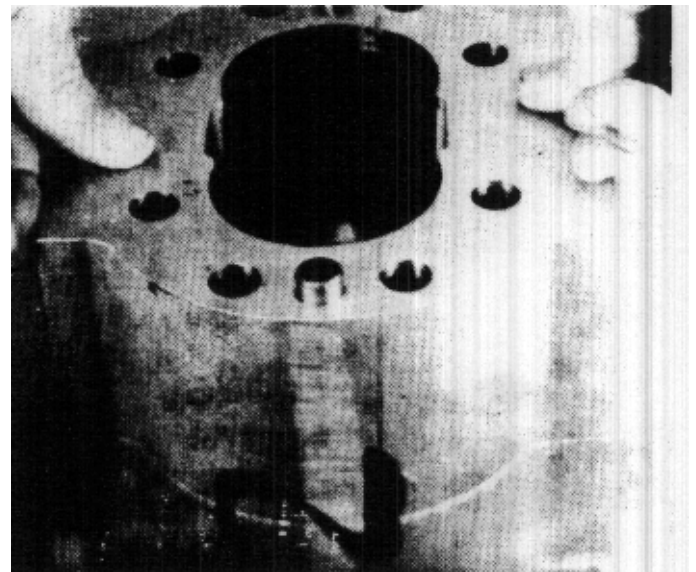

FIGURE 104

44. Repeat (as applicable) Steps 29 through 38. Make sure that Step 31 is followed closely.

45. Install stud (42).
46. See applicable seal Replacement Instructions.
47. Install o-rings (35) on bearing extensions of flange plate (1). Install o-ring (33) in the flange plate groove. Use clean heavy grease to hold the oring in the groove. (Use caution while the seal is being moved down the shaft. If the shaft extension is splined, heavy grease applied to the splines will help prevent damage to the seal. If the shaft extension has a keyway, a thin piece of shim stock covering the keyway will prevent cutting of the seal.)
48. Complete installation of the flange plate (1) by following applicable portions of the procedures described in Step 40. Use the same precautions.
49. Install washers (22) and nuts (21). The nuts should only be run down until they are snug.
50. Place the motor in a machinist vise, using a clean block of wood between the flats on each side of the motor and the jaws of the vise.
51. Tighten two opposite nuts on each end and apply a torque of 80 to 90 lb/ft. (165-175 lb/ft. on SPM25) (Fig. 105)

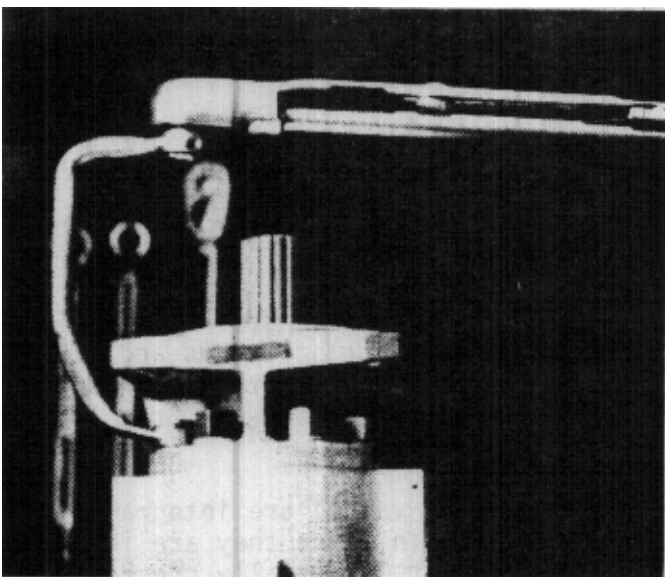

FIGURE 105

52. Use 10" wrench and check to see if the drive shaft will turn freely. The shaft will be tight but should turn with a maximum of 5 to 10 lb/ft. of torque applied. (Fig. 106)

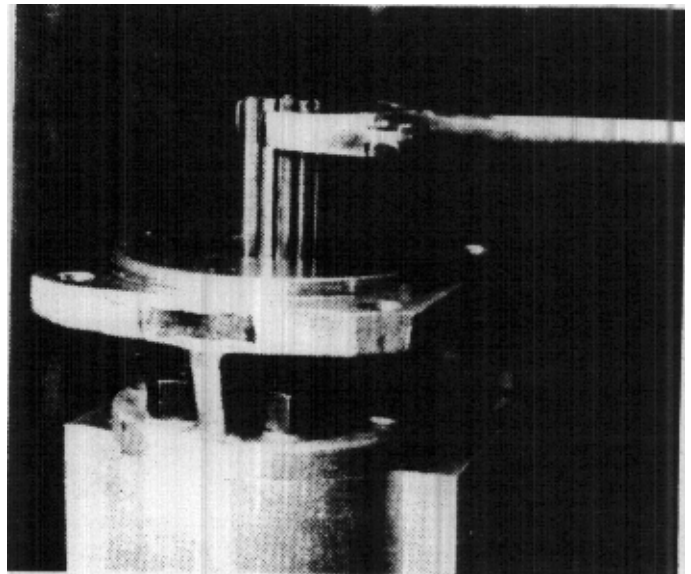

FIGURE 106

53. If the shaft will not turn properly, disassemble the motor and examine the parts for burrs or foreign material causing interference with the moving parts.
54. Remove the cause and reassemble the motor.
55. When the shaft turns properly, tighten all remaining nuts and apply a torque of 80 to 90 lb/ft. each (165-175 lb/ft. on SPM25).
56. Remove the motor from the vise to assemble the valve parts in the valve body (3).

57. Install a piston (27) and spring (32) in each piston bore. (Fig. 107)

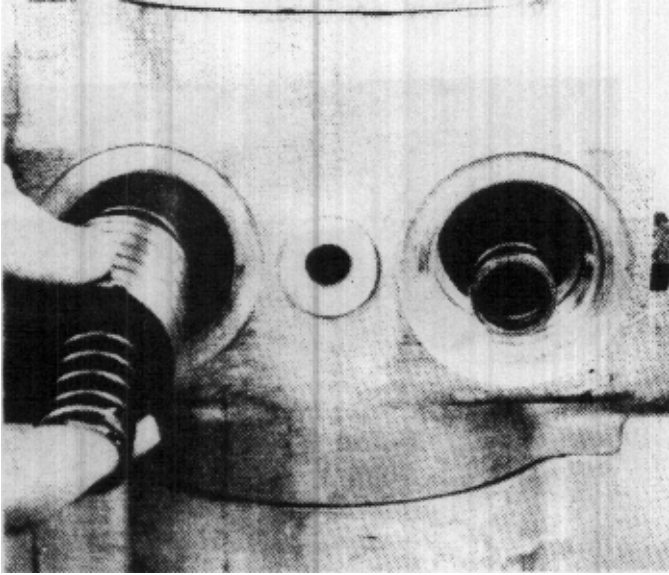

FIGURE 107

58. Put o-rings (40) on plugs (39) and install each in its proper place.

INSPECTION OF MOTOR PARTS

1. Visually inspect all parts. There will be a gear track on the inside of the motor body. Measure the depth of this gear track. The nominal depth of this cut is .008" (0,203 MM) and should not exceed .015" (0,381 MM). If the track is less than .015", the body is acceptable for assembly providing it is not cracked or otherwise damaged.
2. Examine the pressure plates. They should not show excessive wear on the bronze side. If deep curved wear marks are visible, replace the plates.
3. Examine the gears. If excessive wear is visible on the journals, sides, or shaft where it rotates in the seal, replace both gears.
4. If any of the internal parts show excessive wear, replace them with new parts.
5. For further information on inspection of parts, see applicable portions of PUMP TROUBLESHOOTING GUIDE, or DIAGNOSING TYRONE GEAR PUMP FAILURES.

INSPECTION OF VALVE PART

1. Visually inspect the valve spool for scratches and burrs.
2. Examine the spring for cracks and breaks.
3. Examine the valve spool bore in the valve body for scratches and burrs. Burrs or minor scratches can be removed with Number 400 Grit (only) Emery Cloth.
4. The check valves are integral with the body in which they are located and cannot be visually checked, but it is highly unlikely they will ever cause trouble.

SEAL REPLACEMENT INSTRUCTIONS
SPM20

1. Stand the motor on end, shaft up. Use a brush and solvent and wash the flange end thoroughly. Dry it with compressed air or by thorough wiping with a clean, dry rag. This action will help to prevent foreign material from entering the motor.
2. Loosen and remove nuts and washers holding the flange plate onto the motor body. Lift the flange up and off the shaft. Remove the o-ring from its groove. (Fig. 108).

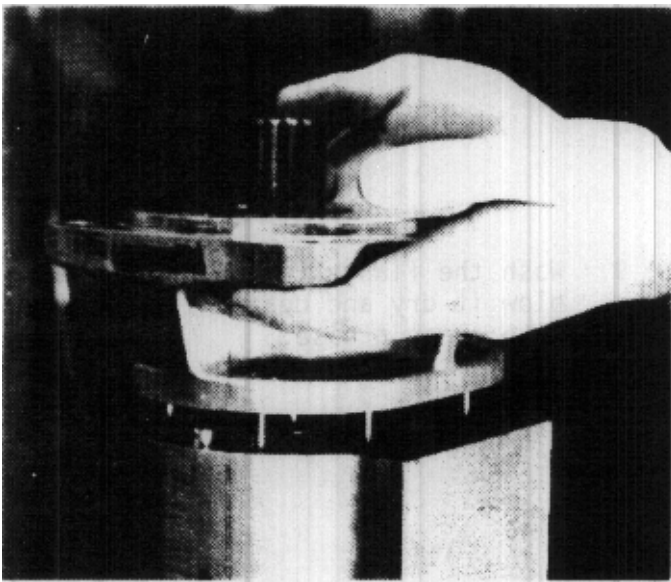

FIGURE 108

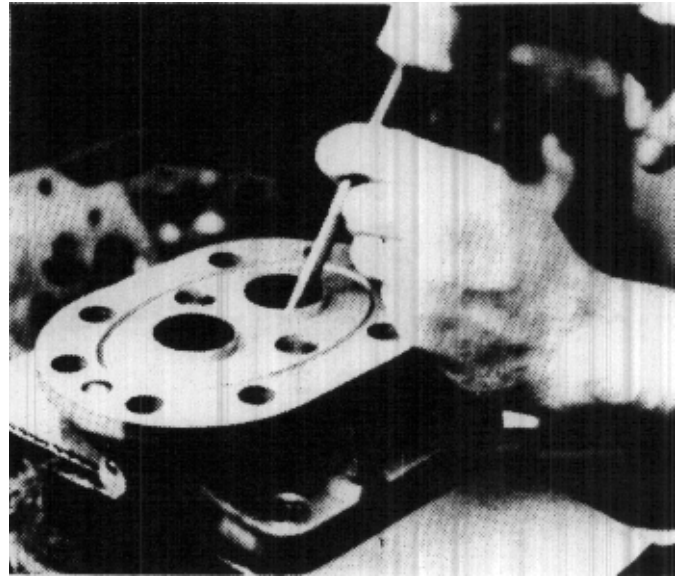

FIGURE 109

3. Lay the flange on a smooth, clean surface and remove the snap ring with snap ring pliers.
4. Turn the plate over and lay it down on the open jaws of a vise or other appropriate support. Use a punch and mallet (or a light hammer) and tap the old seal out of the bore. USE EXTREME CARE IN THIS PROCEDURE. Do not mar the machined surfaces of the flange. Move the punch around the seal so that it produces even movement of the seal down the bore. (Fig. 109)
5. After the seal has been removed, wash the flange plate in clean solvent, dry it, groove which are deep enough to preclude its re-use. Polish the bore with only number 400 Emery Cloth.
6. Wash and dry the bore again and place the flange between the open jaws of a vise. With the back of the flange facing the stationary jaw, place a clean, smooth block of wood between the jaw and the flange to protect the machined surfaces (Fig.110)

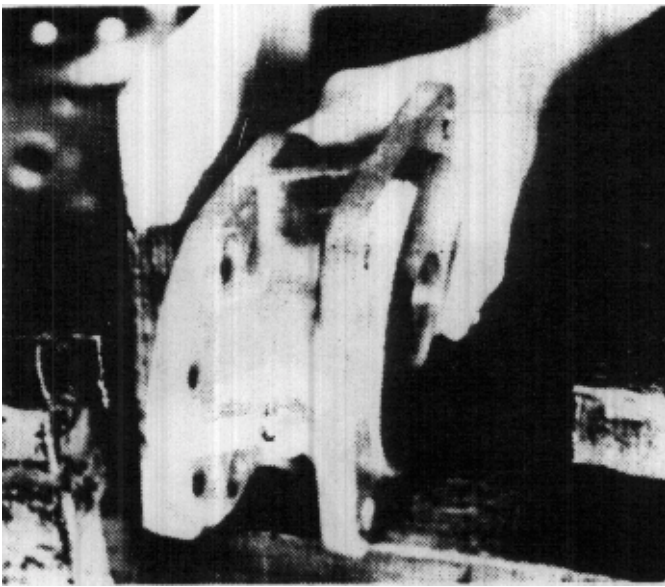

FIGURE 110

7. Position the new seal over the bore with the rubber lip entering first. Center a press ring (or a socket wrench of appropriate size) against the metal back of the seal and close the vise against it. Carefully tighten the vise and press the seal into bore until it seats against the shoulder in the bore. (Fig. 111)

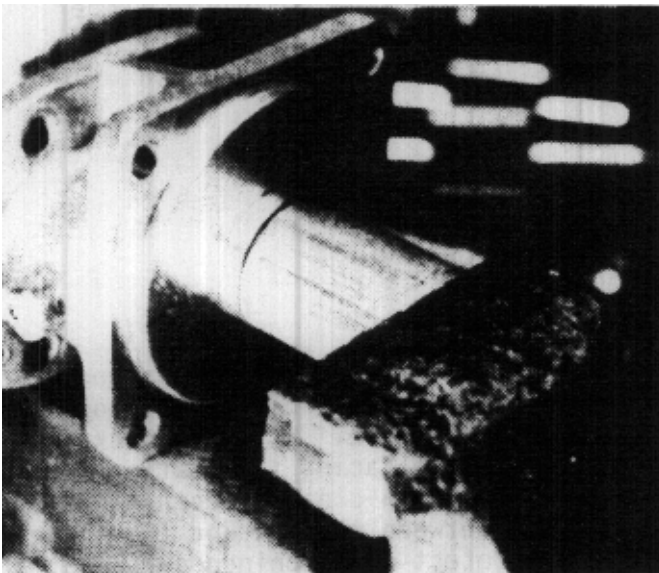

FIGURE 111

8. Install the snap ring, making sure it snaps into the groove properly. (Fig. 112)

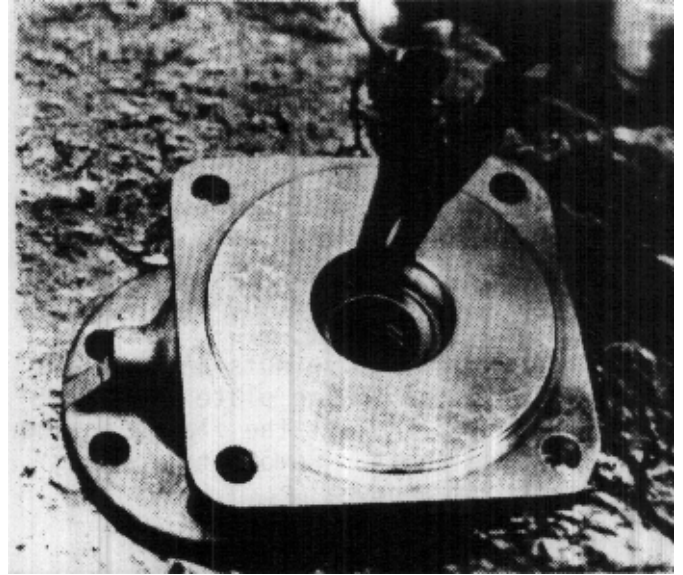

FIGURE 112

9. Wash the flange in clean solvent, blow it dry and coat the seal lips with clean grease.

10. Install a new o-ring in the flange plate o-ring groove and the plate should be ready to be reinstalled on the motor.

SEAL REPLACEMENT INSTRUCTIONS

SPM25

1. Stand the motor on end, shaft up.
2. Use a brush and solvent and wash the entire flange end of the motor thoroughly. Blow it dry with compressed air. This procedure is necessary in order to remove foreign material which might get into the motor during seal replacement.
3. Remove the seal plate capscrews and lift the plate up and off the shaft. Remove the plate o-ring from its groove. (Fig. 113)
4. Press the old seal out of the plate. **USE EXTREME CARE IN REMOVING THE SEAL.** Press it straight out of the seal bore. If a punch and hammer are used, move the punch around the seal so that it causes even movement of the seal down the bore. Do not mar machined surfaces of the plate. (Fig. 114)

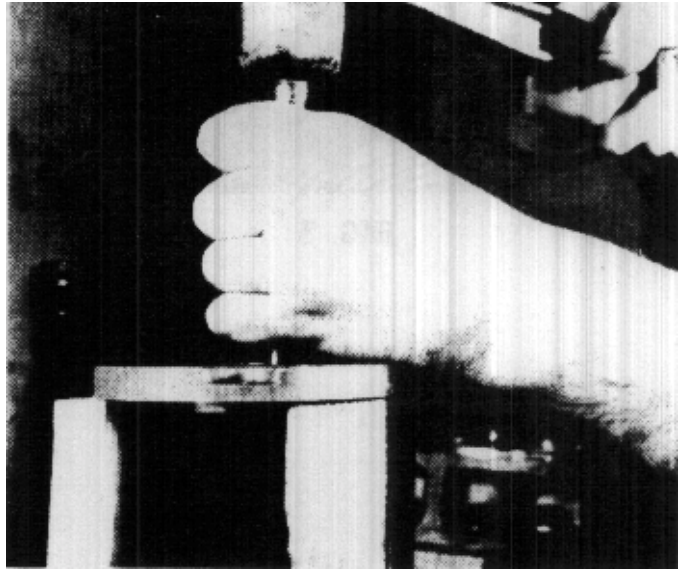

FIGURE 114

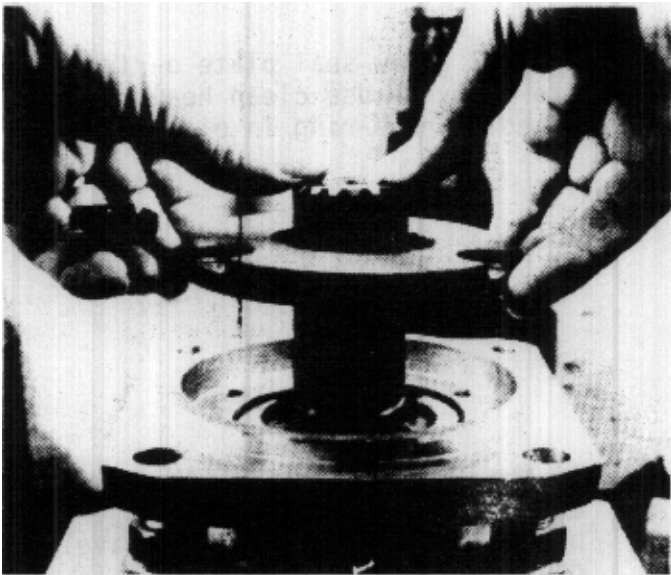

FIGURE 113

5. After the seal has been freed from the bore, wash the seal plate in solvent and blow it dry. Inspect the bore for significantly deep grooves and scratches. Polish the bore only with Number 400 Grit Emery Cloth.
6. Wash and dry the plate again and apply a liquid gasket sealer (such as "Permatex") to the bore surface.

7. Place the seal plate between the open jaws of a machinist's vise with the cast surface against the stationary jaw. (Fig. 115)

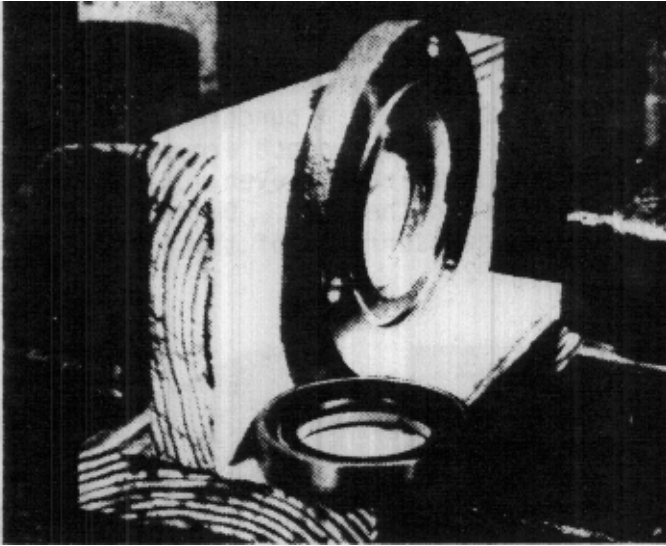

FIGURE 115

9. Place a smooth, clean block of wood against the rubber face of the seal. Carefully tighten the vise and press the seal into the bore. The seal will seat with about half of its thickness dimension still protruding from the bore. This protrusion serves as a pilot while reinstalling the plate on the flange. (Fig. 117)

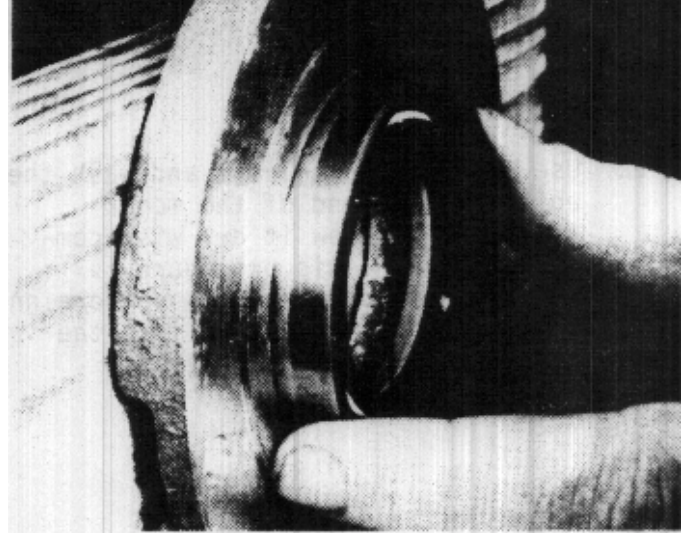

FIGURE 117

8. Position the metal face of the new seal over the seal bore. Make sure it is centered and trued for entry into the bore. (Fig. 116)

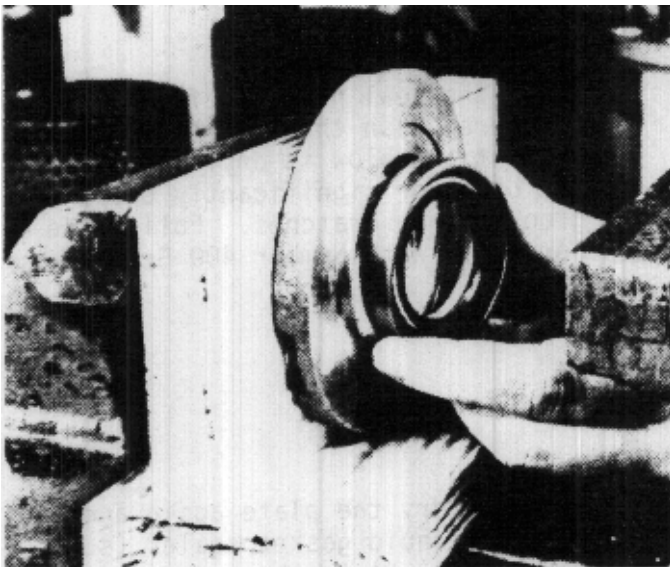

FIGURE 116

10. Install a new seal plate o-ring in its groove. Use clean heavy grease to hold the o-ring in place.
11. If the motor drive shaft is keyed, cover the keyway with thin tape to protect the seal lip as it travels down the shaft. If the shaft is splined, coat the splines with clean, heavy grease. (Fig. 118)

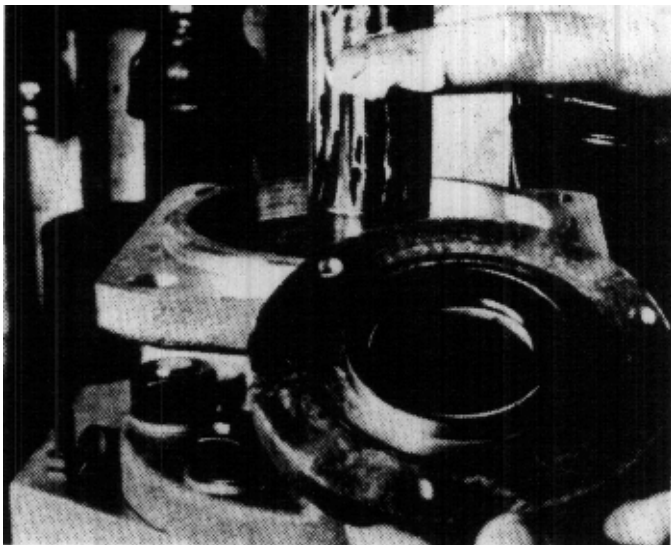

FIGURE 118

12. Place the assembled seal plate over the shaft and carefully slide it down into position on the flange. Install and tighten the seal plate capscrews.

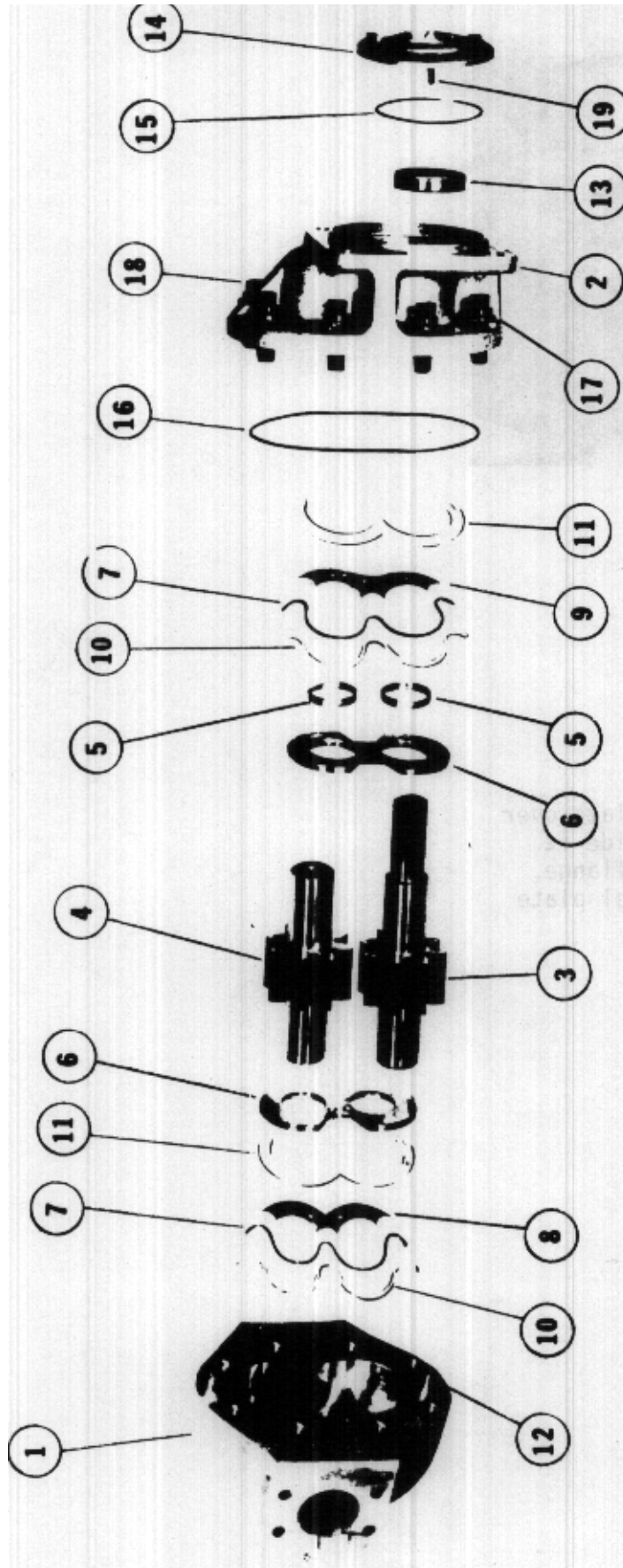

FIGURE 119

PARTS IDENTIFICATION			
ITEM NO.	NAME OF PART	ITEM NO.	NAME OF PART
1	BODY	11	RING RETAINER
2	FLANGE	12	DOWEL
3	DRIVE GEAR	13	SEAL
4	IDLER GEAR	14	SEAL RETAINER
5	STEEL RING	15	O-RING (SEAL RETAINER)
6	PRESSURE PLATE	16	O-RING(BODY)
7	O-RING	17	FLAT WASHER
8	REAR ISOLATION PLATE	18	CAPSCREW (FLANGE)
9	FRONT ISOLATION PLATE	19	CAPSCREW (SEAL RETAINER)
10	BACK-UP RING		

FIGURE 120

DISASSEMBLY

1. Clean the outside of the pump thoroughly.
2. Place the pump in a machinist's vice securely, shaft up, using a cleanblock of wood between the flats on either side and the jaws of the vice. This keeps from marring the machined surface of the pump and causing leakage at the port connectors.
3. Remove all capscrews from the flange.
4. Coat the shaft extension with clean grease. This will help to keep from damaging the rubber lips of the seal during removal of the flange.



FIGURE 121

5. Lift the flange off the pump, keeping the flange as straight as possible during removal. If the flange is stuck, use a wood mallet or plastic hammer to tap around the edge and loosen.

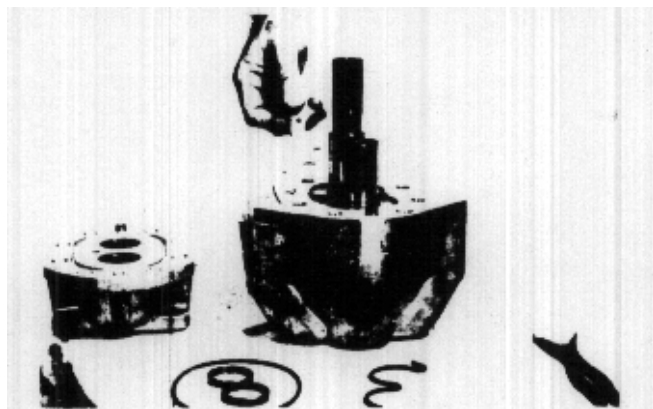

FIGURE 122

6. Remove all O-rings, ring retainer, steel rings, isolation plate, and back-up rings that are in view.

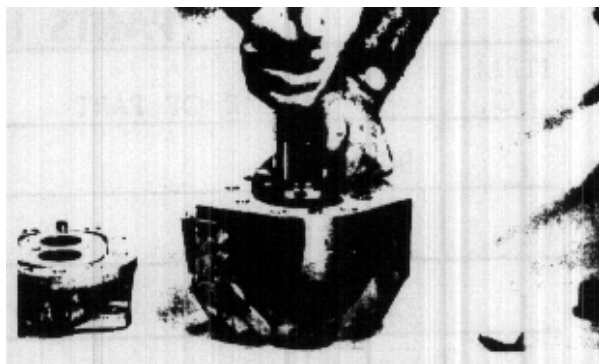

FIGURE 123

7. Grasp the drive shaft extension and lift the drive shaft slightly with a quick upward motion. This will dislodge the pressure plate from inside the bore of the body. Using the thumb and forefinger of the other hand in the slots of the pressure plate and releasing the hold on the drive shaft, lift the pressure plate from the pump.

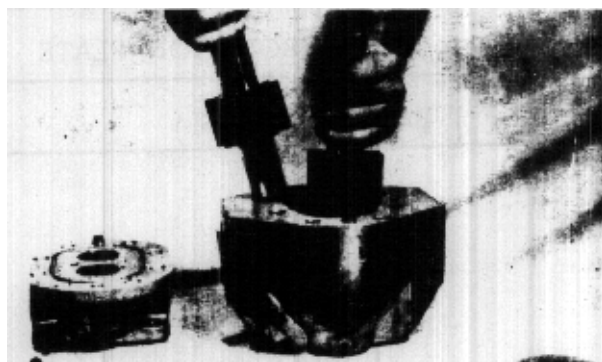

FIGURE 124

8. Lift the gears straight up out of the pump body.

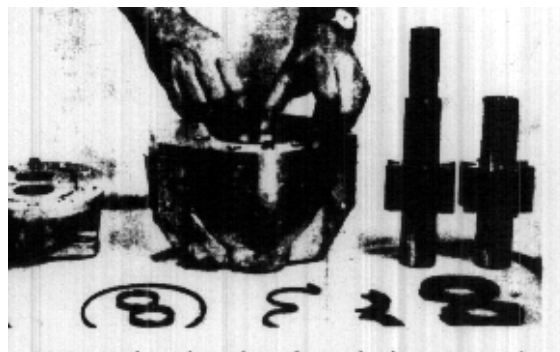

FIGURE 125

9. Using the thumb of each hand in the holes in the bottom pressure plate, lift it from the pump, working it easily out. **USE EXTREME CARE IN THE REMOVAL OF THIS PLATE. DO NOT PRY OR FORCE IT OUT.**

REASSEMBLY

10. Remove the remaining O-ring, back-up ring, retainer ring, and isolation plates.

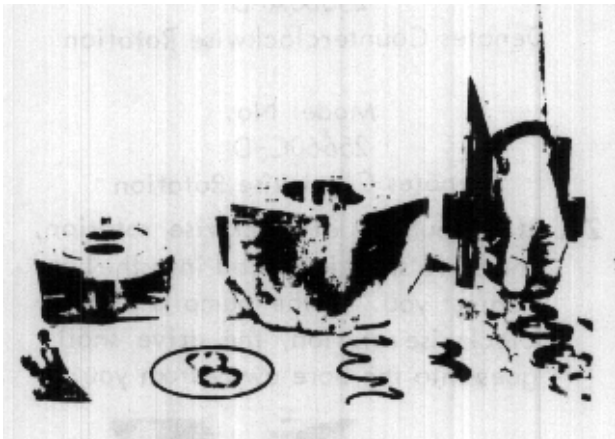

FIGURE 126

11. Wash all ports thoroughly with clean solvent and blow dry. This should remove any foreign matter trapped in the pump.
12. Inspect the parts carefully. For detailed instructions see INSPECTION OF PARTS.



FIGURE 127

13. Place the body of the pump so that the isolation plate retainer cusp is to your right. The cusp is shown above in the bottom of the pump body.
14. Using clean hydraulic oil, coat the inside of the pump body liberally. This will insure easier assembly.



FIGURE 128

15. Examine the two isolation plates. You will find that they are slightly different. Choose the one which has rounded edges as shown. Install this

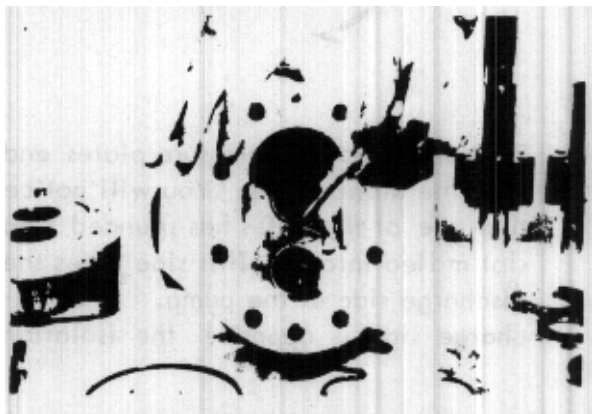

FIGURE 129

one in the bottom of the pump, with rounded edges down and long end to the drive shaft side of pump.

16. Install O-ring retainer into place on the opposite side of the bores from the isolation plate.

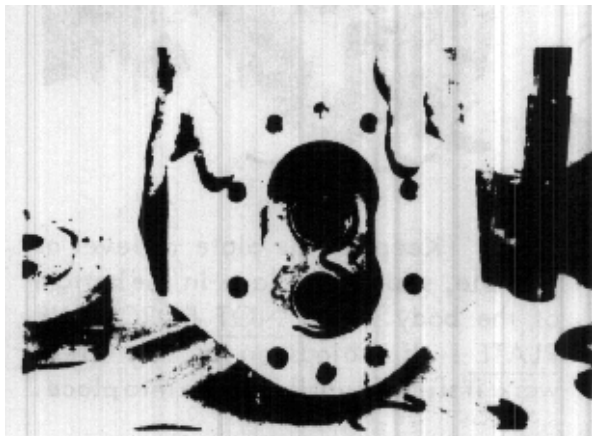

FIGURE 130

17. Place the back-up ring into position around the bores as shown above.

REASSEMBLY

18. In fall the O-ring in place against the back-up ring so that it seats itself into the groove in the edge of the back-up ring.

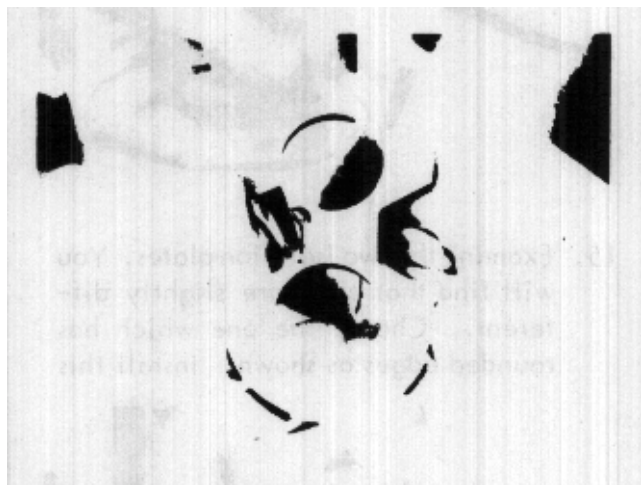

FIGURE 131

19. Pick up one of the pressure plates and note the bronze side. You will notice that one of the sides has rounded trap slot milled into it. This side faces the discharge side of the pump. The discharge side is opposite the isolation

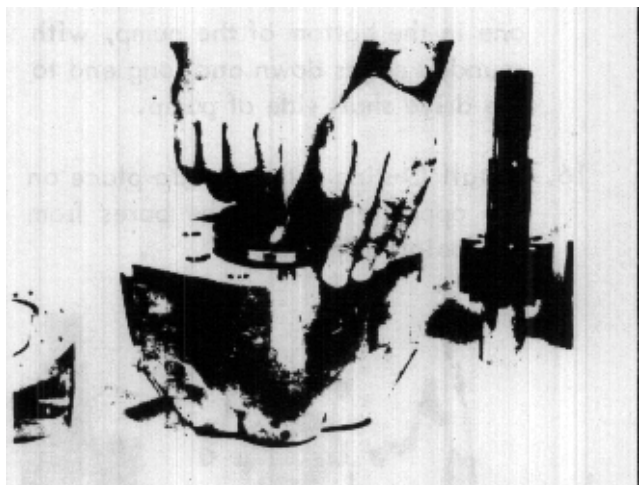

FIGURE 132

plate. Keeping the plate as level as possible, slide into place in the bottom of the body. **DO NOT FORCE THE PLATE!** If it binds on the way down, work it slightly until it slides into place.

20. Check the name plate on the body of the pump for the pump rotation.

EXAMPLE

Model No.
25660A-D

Denotes Counter clockwise Rotation

Model No.
25660C-D

Denotes Clockwise Rotation

21. If the pump is of clockwise rotation, the drive shaft is placed into the bore nearest you. If the pump is of anti-clockwise rotation, the drive shaft goes into the bore away from you.

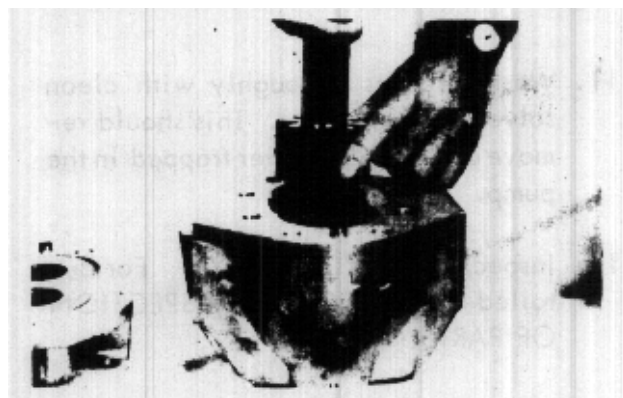

FIGURE 133

22. Insert the drive shaft into the proper bore for this pump. Do not drop into place, but slide it into place gently as dropping will damage the bronze pressure plate.

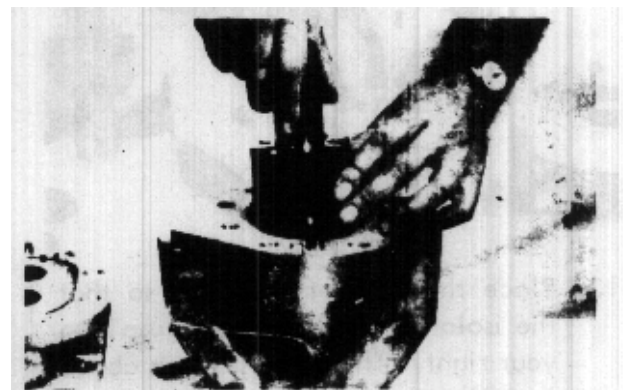

FIGURE 134

23. Install the idler gear into the opposite bore of the pump. The long journal on the idler gear should be up.

REASSEMBLY

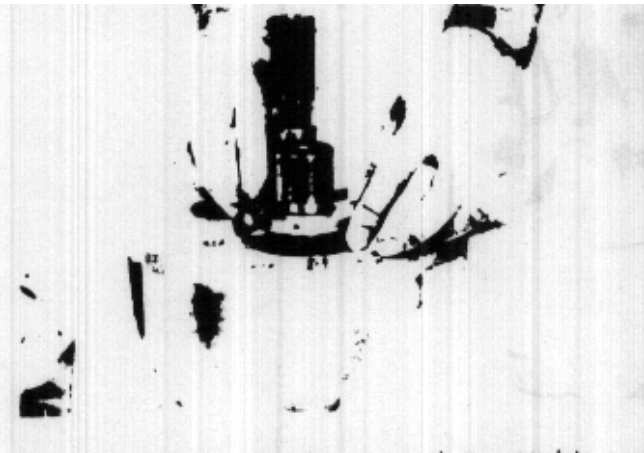

FIGURE 135

24. Pick up the other pressure plate. Holding the bronze side down, and the rounded trap slot facing the discharge side of the pump, install it into position over the gears.

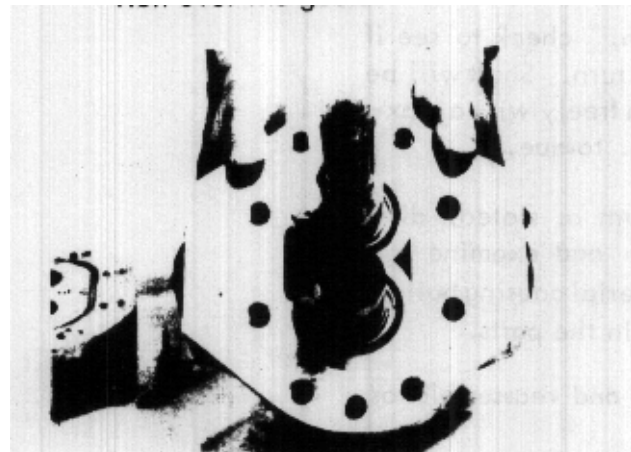

FIGURE 136

25. Slide the two steel rings over the shafts and seat them into the recesses in the pressure plate.
26. Place the remaining isolation plate in place on the suction side on top of the pressure plate. Either side up is right, but with long end to drive shaft.
27. Install the retainer ring.
28. Install the back-up ring.
29. Install the O-ring as in the bottom of the pump.
30. Examine the seal. If it is damaged or if

previous leakage has been evidence, replace. (See SEAL REPLACEMENT for detailed instructions.)

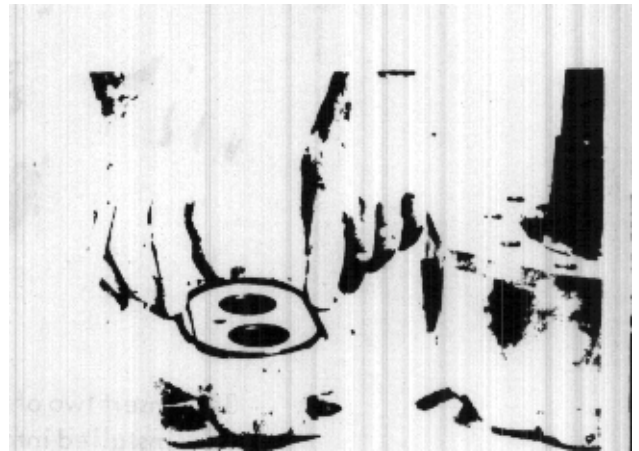

FIGURE 137

31. Gently wipe the machine surface of the flange with emery cloth. Wash in solvent and blow dry.
32. Install the body O-ring into the groove in the flange. Use heavy grease to hold it in place.



FIGURE 138

33. Coat the drive gear extension with heavy grease to protect the lips of the seal.
34. Slide the flange over the drive gear extension and seat it against the pump body.

REASSEMBLY



FIGURE 139

35. Insert two of the capscrews with washers installed into opposite holes and torque to 175 lbs. ft.
36. Using a 10" wrench, check to see if the drive shaft will turn. Shaft will be tight but should turn freely with a maximum of 5 to 10 lbs. torque.
37. If shaft will not turn as stated, disassemble the pump and examine for burrs or foreign material causing build-up or interference in the parts.
38. Remove the cause and reassemble as before.
39. When shaft turns properly, tighten the remaining nuts and torque to 175 lbs. ft. each.

SEAL REPLACEMENT

1. Stand the pump on end, shaft up.
2. Using a brush and solvent, wash the entire flange end of the pump ONLY, and blow dry. This is to remove any foreign material which might get into the pump during replacement of the seal.



FIGURE 140

3. Remove the seal retainer capscrews.
4. Lift the seal retainer off the flange.

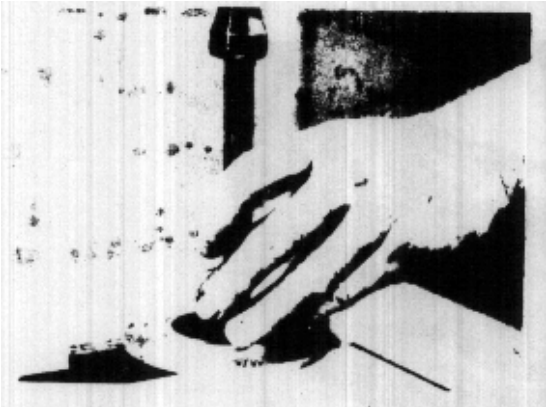

FIGURE 141

5. Press the old seal out of the retainer. **USE EXTREME CARE IN REMOVAL OF THE SEAL.** Press it straight out of the bore of the retainer. Do not mar the machined face of the retainer.

6. Wash the seal retainer in solvent and blow dry.
7. Place the cast surface of the retainer against the stationary jaw of a machinist's vise.
8. Place the metal face of the seal in position against the retainer. Be sure that the seal is well centered over the bore.

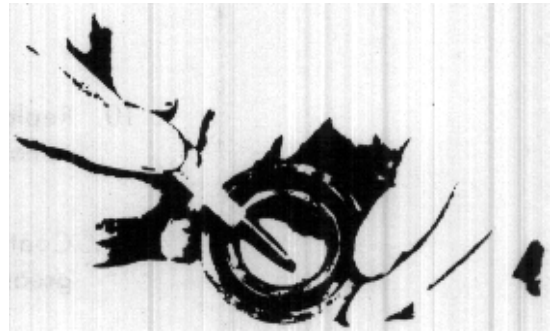

FIGURE 142

9. Place a clean block of wood against the rubber face of the seal and by tightening the vise, press the seal into the bore.

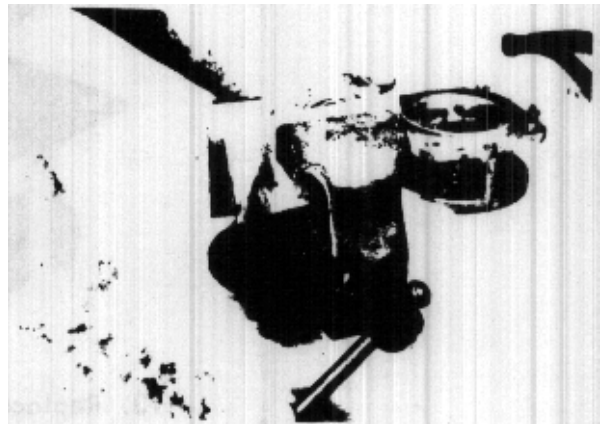

FIGURE 143

THE SEAL WILL SEAT ITSELF WITH ABOUT HALF OF THE SEAL THICKNESS PROTRUDING FROM THE RETAINER. THIS PROTRUSION SERVES AS A PILOT IN RE-INSTALLING THE RETAINER.

SEAL REPLACEMENT

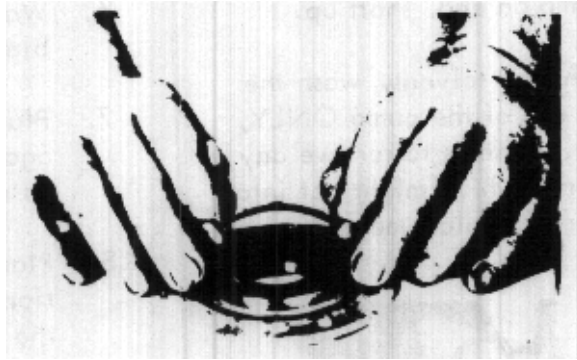

FIGURE 144

10. Replace the O-ring wing, heavy grease to hold it securely in the O-ring groove.
11. Coat the shaft liberally with heavy grease to protect the lips of the seal.
12. Replace the retainer assembly by carefully sliding over the shaft.

13. Replace the capscrews and tighten.

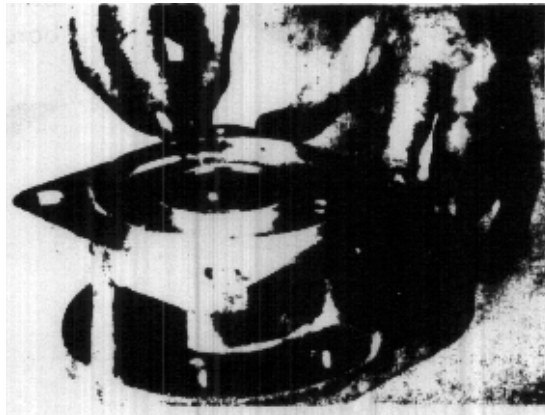

FIGURE 145

BEARING REPLACEMENT-INSPECTION OF PARTS

BEARING REPLACEMENT

MOBIL-MASTER SERIES 20 & 25

Mobil-Master Series 20 and 25 Pumps are built with the highest capacity bearings available. However, if the pump is run on a system with contaminant present in the oil, or under certain other conditions, bearing failure may be experienced. In the event of bearing failure the bearings may be replaced if the gears have not cut a track in the housing deeper than .015 inches.

To remove the old bearings, disassemble the pump and place the body in a vise. Clamp on the sides of the body using cardboard to prevent marring by the vise jaws.

Using the small keyhole type hack saw, cut through the bearing opposite the oil groove. Be sure the saw cuts completely through the bearing shell, but cuts as little as possible into the aluminum bore.

After the cut is made, grip the bearing with vise-grip pliers and remove with a twisting motion (body bearings). Flange bearings can be wedged out with a screw driver. Take care not to damage the bores. After removal, wash the parts thoroughly in solvent. Press in the body bearings so that they protrude above the surface . 220/. 230. Press flange bearings in . 090 below surface. The split in the bearing goes in the same location as was the oil groove in the bronze bearings.

Install the remaining parts of the repair kit and replace on the machine. No break-in is necessary and the unit is ready to operate at full capacity.

INSPECTION OF PARTS

1. Visually inspect all parts. There will be a gear track on the inside of the pump body. Measure the depth of this gear track. If the groove is deeper than .005 (five thousandths) of an inch, the body should be rejected for further use. If the track is less than .005, the body is all right for reassembly provided it is not cracked or damaged otherwise.
2. Examine the pressure plates. They should not show excessive wear on the bronze side. If deep curved wear marks are visible, reject them.
3. Examine the gears. If excessive wear is visible on the journals, sides or face of the gears, or at the point where it rotates in the seal, reject them.
4. If any of the internal parts show excessive wear, replace all the parts with the cartridge kit.

BOLT TORQUE CHART

BOLT SIZE	SAE Grade 5		SAE Grade 8	
	Min.	Max.	Min.	Max.
1/4	10	11	14	16
5/16	20	23	30	33
3/8	35	40	52	59
1/2	85	95	103	145
5/8	170	190	250	290
3/4	280	320	420	470
7/8	440	490	670	750
1	660	740	1010	1130
1-1/8	890	1005	1480	1645
1-1/4	1260	1420	2070	2320

FIGURE 146



Grade 5--3 radial dashes
120 degrees apart.



Grade 8--6 radial dashes
60 degrees apart.

FIGURE 147

Bolts found to be loose should be removed, wiped clean, and re-installed using LOCTITE 242 (blue-medium strength) or LOCTITE 271 (red-high strength).

HYDRAULIC FITTING TORQUE CHART

1. Wipe fittings.
2. Apply LOCTITE Hydraulic Sealant to the first 1/3 (closest to the flange or seas) of the fitting threads.
3. Seat flange hand tight, then torque to specification.

MAXIMUM RECOMMENDED TORQUE VALUES
FOR J I C SWIVEL NUTS (37° SEAT)

Use this chart every time hydraulic fittings are tightened or checked.

THD. SIZE	SIZE	OD TUBE	FT./LBS. TORQUE
7/16-20	-4	1/4	9
1/2 -20	-5	5/16	15
9/16-18	-6	3/8	20
3/4 -16	-8	1/2	30
7/8 -14	-10	5/8	40
1-1/6 -12	-12	3/4	70
1-3/16-12	-14	7/8	82
1-5/16-12	-16	1-0/0	90
1-5/8 -12	-20	1-1/4	120
1-7/8 -12	-24	1-1/2	131
2-1/2 -12	-32	2-0/0	300
	-40	2-1/2	400
	-48	3-0/0	500

FIGURE 148

These values are the maximum recommended torque values for JIC (37°) Seat Swivel Nuts either swaged or brazed type. The swivel nuts will normally withstand this torque for a minimum of 15 repeated assemblies.

The torque required to seal swivel female fittings or hose couplings to a male connector depends on many variables, such as fluid medium, pressure surface finish, etc. The above values are intended only as a guide for the maximum torque values the fitting may be subjected to.

Procedure: Torque per chart above. Back fitting off 1/2 turn and re-tighten to recommended torque value in chart.

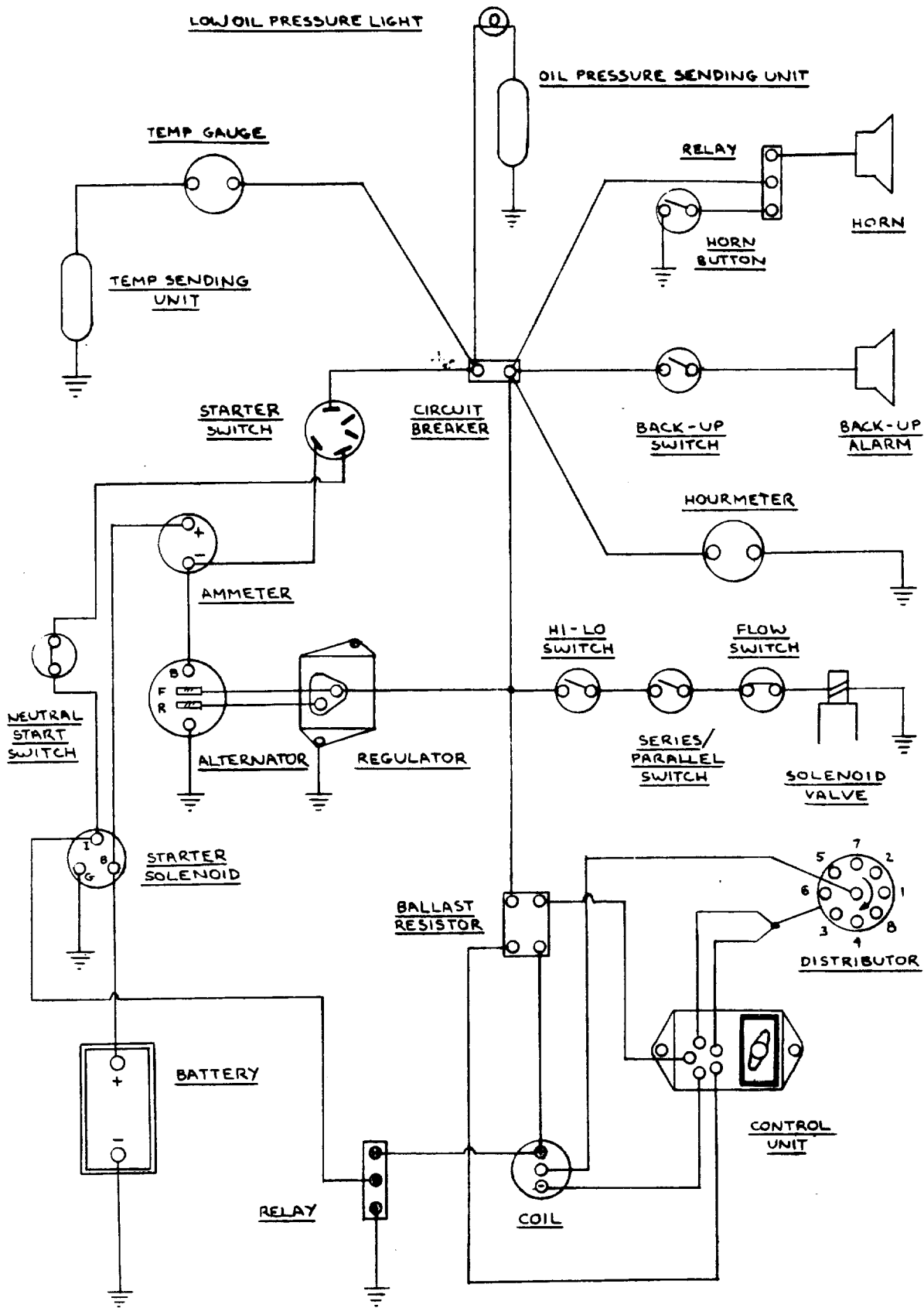

FIGURE 149

- SOLENOID VALVE CIRCUIT SHOWN -IN 4-WHEEL
- HI-LO SWITCH SHOWN IN LO
- SERIES/PARALLEL SWITCH SHOWN -IN PARALLEL
- FLOW SWITCH SHOWN IN LOW FLOW POSITION
- NEUTRAL START SWITCH SHOWN IN NEUTRAL

ELECTRIC SCHEMATIC
MODEL 534 WITH
CHRYSLER ENGINE

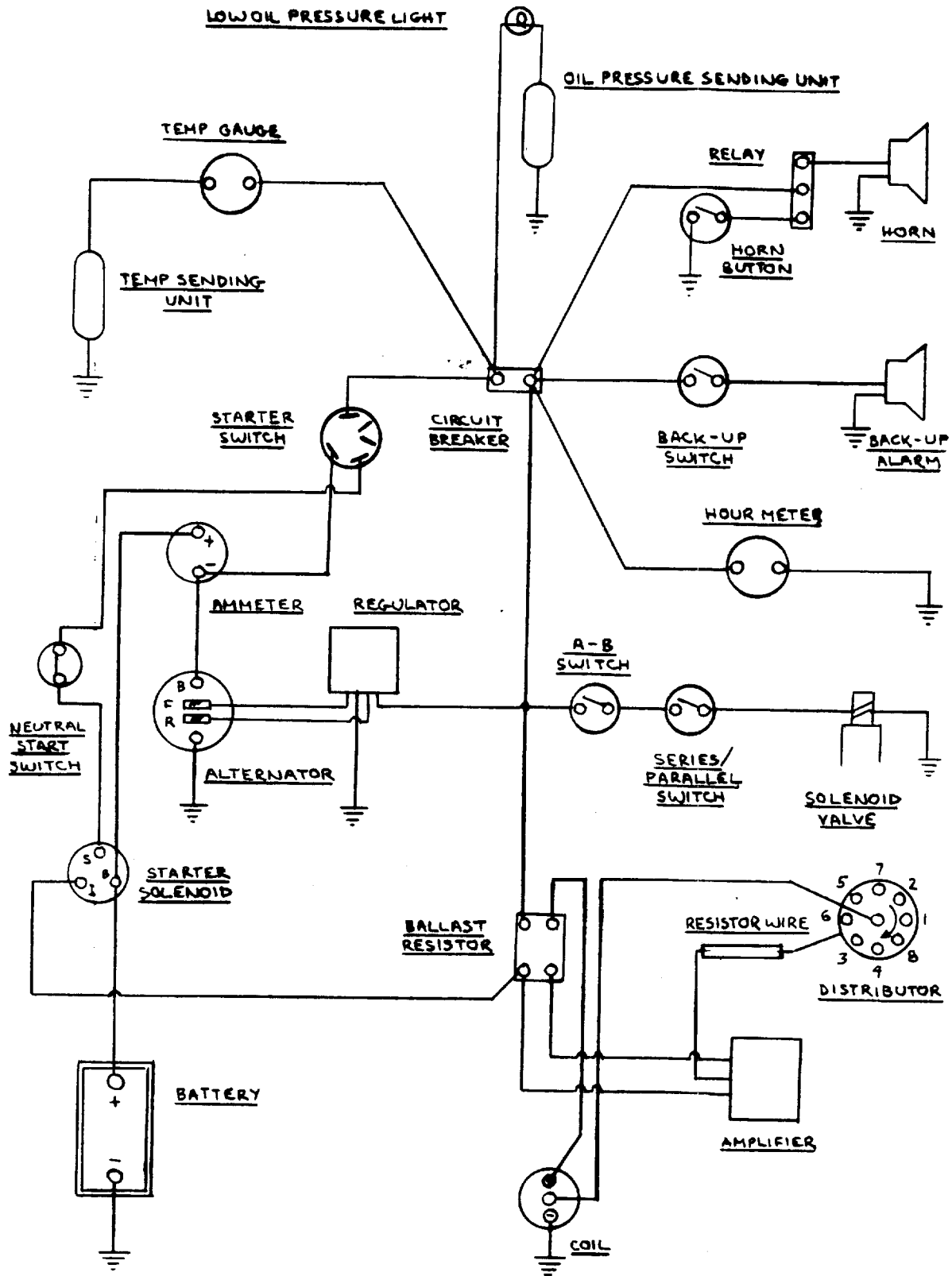

FIGURE 150

- SOLENOID VALVE CIRCUIT SHOWN IN 4-WHEEL
- A-B SWITCH SHOWN IN B
- SERIES/PARALLEL SWITCH SHOWN IN PARALLEL
- NEUTRAL START SWITCH SHOWN IN NEUTRAL

ELECTRICAL SCHEMATIC
MODEL 534 WITH
FORD ENGINE

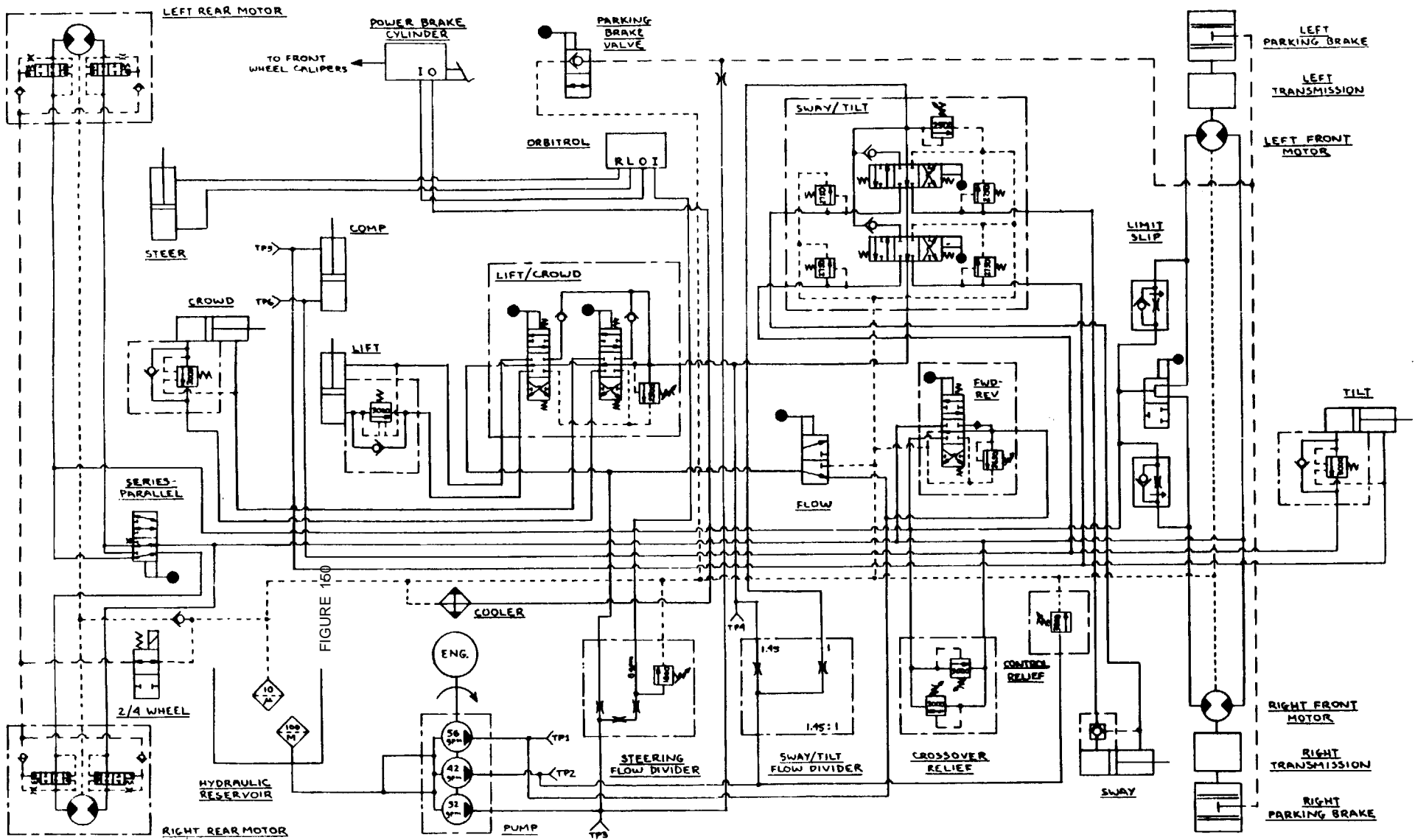

FIGURE 151

- SERIES-PARALLEL VALVE SHOWN IN PARALLEL POSITION (1ST & 3RD GEAR)
- 2-WHEEL / 4-WHEEL SOLENOID VALVE SHOWN IN 4-WHEEL POSITION
- LIFT/CROWD VALVE SHOWN WITH BOTH LEVERS IN NEUTRAL
- PARKING BRAKE VALVE SHOWN WITH BRAKES OFF

- SWAY/TILT VALVE SHOWN WITH BOTH LEVERS IN NEUTRAL
- FLOW VALVE SHOWN IN HIGH-FLOW (3RD & 4TH GEAR)
- FORWARD-REVERSE VALVE SHOWN IN NEUTRAL
- LIMIT SLIP VALVE SHOWN IN OFF POSITION

HYDRAULIC SCHEMATIC
MODEL S34 BEFORE 3/237

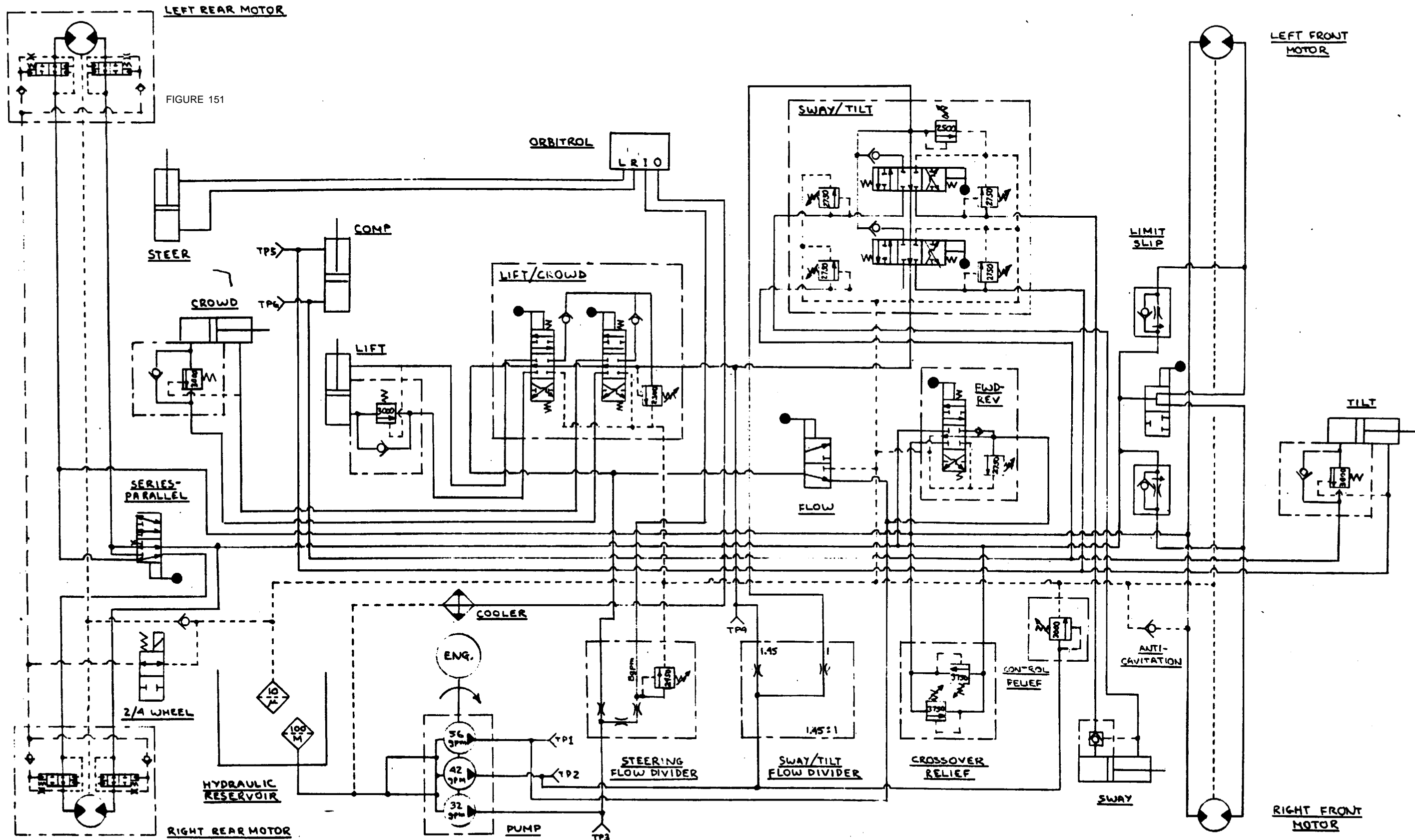

FIGURE 153

- SERIES-PARALLEL VALVE SHOWN IN PARALLEL POSITION (1ST & 3RD GEAR)
- 2-WHEEL/4-WHEEL SOLENOID VALVE SHOWN IN 4-WHEEL POSITION
- LIFT/CROWD VALVE SHOWN WITH BOTH LEVERS IN NEUTRAL
- LIMIT SLIP VALVE SHOWN IN OFF POSITION

- SWAY/TILT VALVE SHOWN WITH BOTH LEVERS IN NEUTRAL
- FLOW VALVE SHOWN IN HIGH-FLOW (3RD & 4TH GEAR)
- FORWARD-REVERSE VALVE SHOWN IN NEUTRAL

HYDRAULIC SCHEMATIC
MODEL 534 S/N 237 & UP

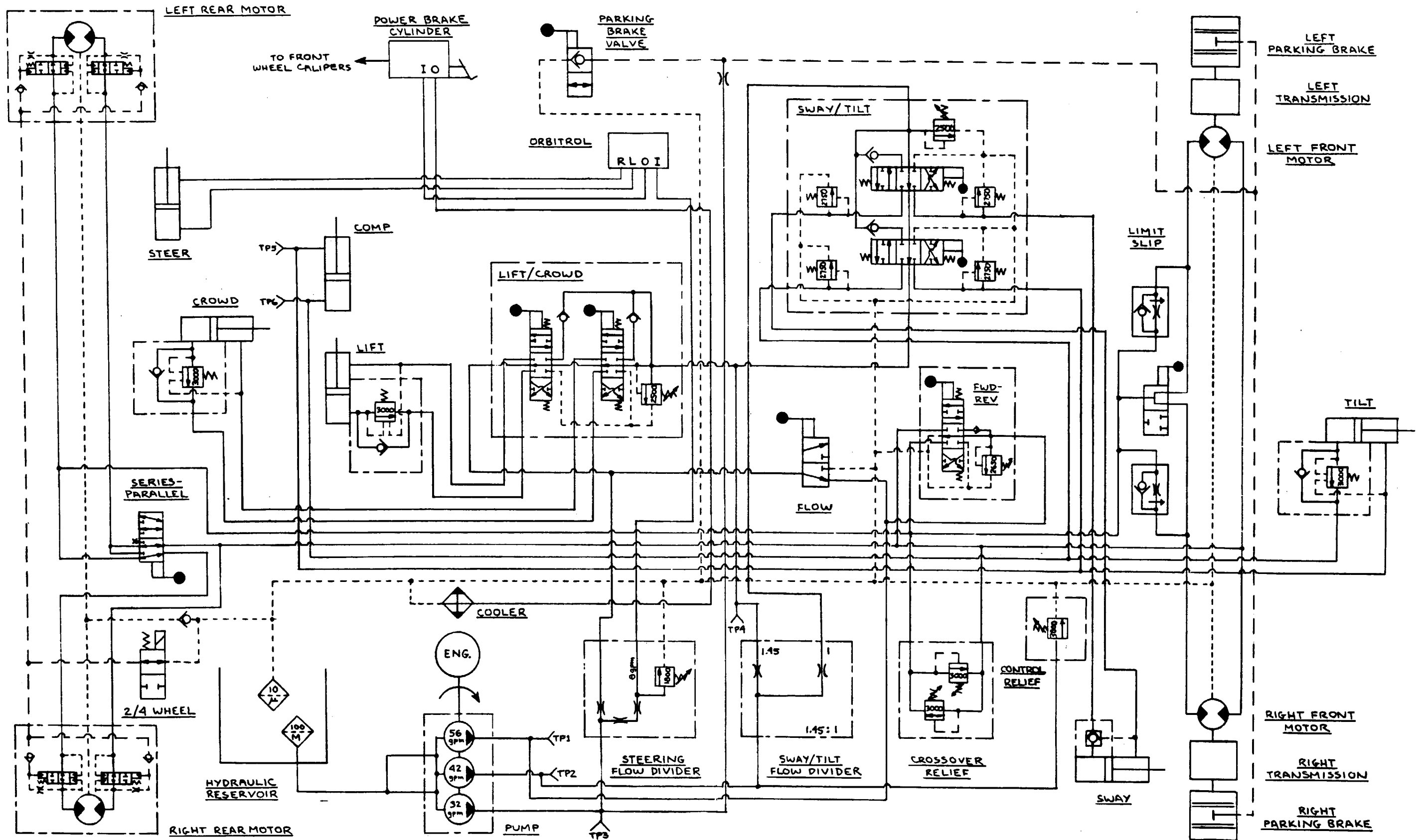

FIGURE 154

- SERIES-PARALLEL VALVE SHOWN IN PARALLEL POSITION (1ST & 3RD GEAR)
- 2-WHEEL/4-WHEEL SOLENOID VALVE SHOWN IN 4-WHEEL POSITION
- LIFT/CROWD VALVE SHOWN WITH BOTH LEVERS IN NEUTRAL
- PARKING BRAKE VALVE SHOWN WITH BRAKES OFF

- SWAY/TILT VALVE SHOWN WITH BOTH LEVERS IN NEUTRAL
- FLOW VALVE SHOWN IN HIGH-FLOW (3RD & 4TH GEAR)
- FORWARD-REVERSE VALVE SHOWN IN NEUTRAL
- LIMIT SLIP VALVE SHOWN IN OFF POSITION

HYDRAULIC SCHEMATIC
MODEL 534 BEFORE 5/12/237