

# CATERPILLAR®

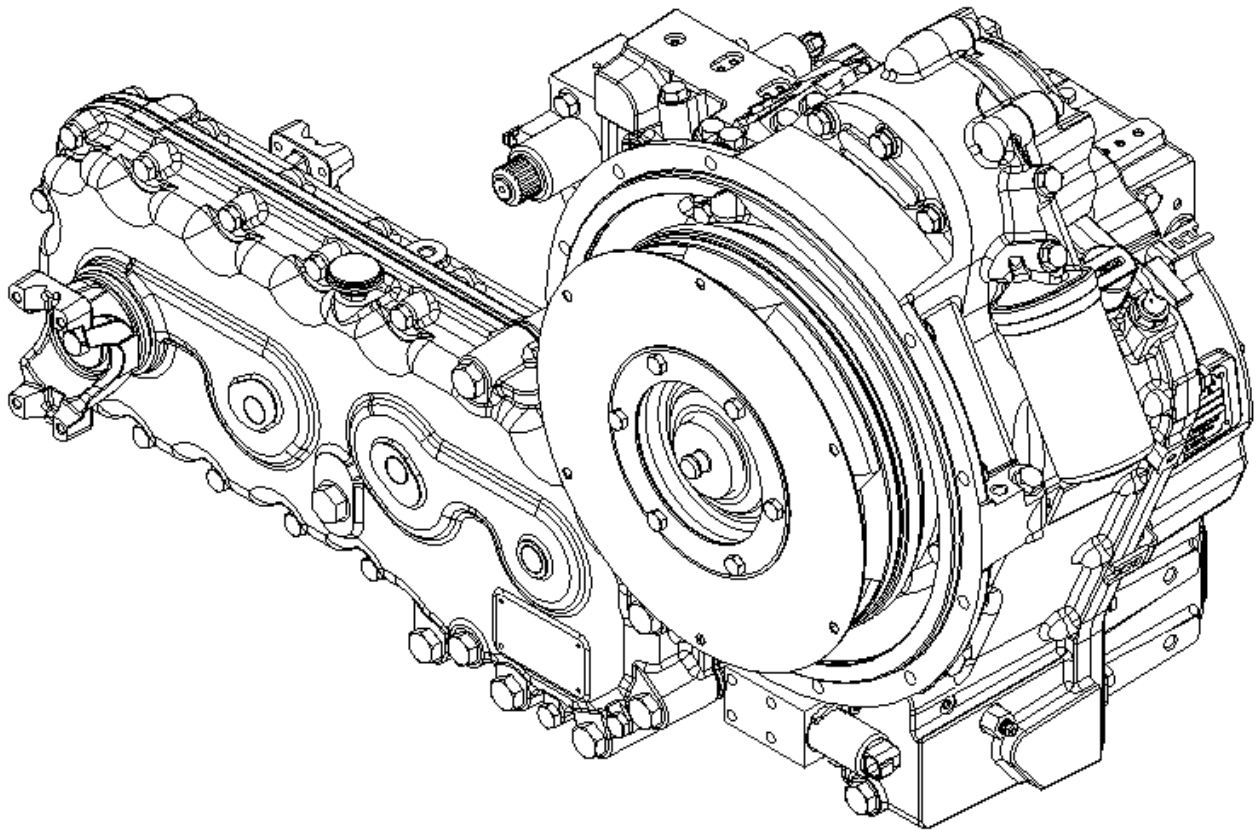

***C Series Telehandler - TH Models***

***Service Manual***



# Contents

SECTION	PAGE	CONTENT
Introduction	1	Safety Notices
	2	Care & Safety
	3	General Safety
	4	Maintenance Safety
	5	Fluroelastemeric Materials Safety
Unit Identification	6	Transmission Serial Plate
Routine Maintenance	7	Service Schedule
Transmission	8	Check Oil level
	8	Change Oil
	9	Renew Filter
Transfer Gearbox	10	Check Oil level
	10	Change Oil
Recommended Lubricants	11	Lubricants
	11	Capacities
Test Ports	12	Location
Electrical Connections	14	Location
	16	Solenoid Data
	17	Connection Protocol
Hydraulic Circuit	18	Schematic
	20	Connections
Method of Operation	21	Clutch and solenoid map
	22	Description
Torque Converter Installation	23	Method
Technical Data	24	Torque Converter / Transmission Pressures
	25	Gear Ratios
	25	Towing procedure
	26	Bolt Torque recommendations
	27	Sealants
	28	Lifting Point Location
	30	Lifting Transmission Assembly
	31	Transmission Weights
Transfer Gearbox removal	33	Remove & refit procedure
Transfer Gearbox Disassembly	35	Dismantling procedure
Transfer Gearbox Reassembly	39	Reassembly procedure
	41	Setting shaft endfloats

# Contents

SECTION	PAGE	CONTENT
Transmission Disassembly	43	Lifting positions
	43	Dual Modulating Valve Removal
	43	Speed Sensor removal
	43	Solenoid removal
	44	Relief Valve removal
	44	Pressure regulator removal
	44	Pump removal
	45	Clutch shaft removal
	47	Torque Converter Housing dismantle
	49	Stator support and pump idler removal
	50	Pump drive disassemble
	52	Reverse idler removal
1st / 2nd Clutch	55	Disassembly procedure
	61	Reassembly procedure
Output Shaft	67	Disassembly & Reassembly
Forward High / 3rd Clutch	69	Disassembly procedure
	74	Reassembly procedure
Forward Low / Reverse Clutch	80	Disassembly procedure
	86	Reassembly procedure
Pump	91	Disassembly procedure
	91	Reassembly procedure
Control Valve	92	Disassembly for examination
Transmission Reassembly	95	Reverse idler replacement
	97	Pump drive reinstallation
	97	Stator support reinstallation
	99	Pump reinstallation
	99	Torque Converter hosing refit
	100	Clutch shaft replacement
	102	Shimming procedure
	103	Clutch Valve replacement
	104	Speed sensor replacement
	104	Relief valve replacement
	104	Pressure regulator replacement
Troubleshooting Guide	107	
Notes	116	
Revision History	117	

# Introduction

## Safety Notices

This publication and information supplied with the transmission may contain safety notices.

Each Notice is identified with a signal word, the meanings are given below.

### WARNING



#### **Warning.**

Denotes a hazard exists. If the information given is not followed and/or proper precautions are not taken the user (or others) could be killed or injured and serious damage could occur to the transmission.

### CAUTION



**Caution.** Denotes a reminder of safety practices. Failure to observe these could result in injury to the user (or others ) and possible damage to the transmission..



**Information.** Information intended to assist the user (or others) to correctly maintain the transmission.

## Care & Safety

Working with any engineered system or product can be hazardous.

When operated correctly and properly maintained these hazards can be reduced .

Do not work with any equipment or tooling until you are sure that it is serviceable, that you understand its function and you know how to control it.

You must always be aware of all relevant safety requirements and legislation.

### **If in doubt ask!**

The equipment covered by this manual is designed to be installed in another product (EG a larger vehicle) be sure to observe any additional safety requirements which relate to the product as a whole as well as those specifically given in this manual.

It is the users responsibility to ensure that the instructions given in this manual are read fully and understood before commencing work.

It is further the users responsibility to ensure that additional instructions given in any manual or instruction relating to the product in which this transmission may be installed are read and understood.

# Care & Safety

## General Safety

**WARNING**



### **Decals.**

This equipment or the product in which it is installed may contain safety decals. You may be killed or injured if you do not obey these decals. Keep decals clean and replace any that are worn, damaged and defaced.

**WARNING**



### **Clothing.**

You may be injured if you do not wear suitable clothing. Wear suitable personal protective equipment (PPE) for the job. PPE may include, a hard hat, safety glasses, safety footwear, well fitted overalls, ear protectors and industrial gloves. Keep overall cuffs fastened, do not wear a necktie or scarf and keep long hair covered or restrained.

**WARNING**



### **Alcohol & Drugs**

It is extremely dangerous to you and others to operate equipment whilst under the influence of drugs or alcohol. Do not consume alcoholic drinks or take drugs before or whilst operating or working on this equipment. Be aware that some medicines can cause drowsiness.

**WARNING**



### **Lifting Equipment**

You can be killed or injured if you use faulty lifting equipment . Make sure that all lifting equipment is in good condition, suitable for the job and complies with all applicable legislation. Do not work under any raised equipment.

**WARNING**



### **Duty of Care**

Whilst you are working take care and stay alert. Work with caution, you have a duty of care to yourself and your colleagues to work safely.

**WARNING**



### **Condition**

Do not use equipment or tooling which is defective or has missing parts.

**WARNING**



### **Controls**

You can be killed or seriously injured if the controls of the vehicle in which the transmission is installed are not isolated before commencing work.

**WARNING**



### **Engine**

The engine of the vehicle in which the transmission may be installed may have exposed rotating parts. Do not open the engine cover with the engine running.

# Care & Safety

## Maintenance Safety

**WARNING**



### **Maintenance**

Only attempt maintenance in which you are competent. To avoid injury or damage ensure work is undertaken by a specialist engineer.

**WARNING**



### **Hydraulic fluid**

Hydraulic fluid under pressure can penetrate the skin. Do not use bare hands to check for hydraulic leaks. If hydraulic fluid penetrates your skin seek medical help immediately.

**WARNING**



### **Pressure**

Ensure all trapped hydraulic pressure is vented before removing hydraulic fittings or devices.

**WARNING**



### **Oil**

Oil is toxic. If you ingest oil do not induce vomiting, seek medical advice immediately.

Some oils especially when used can cause cancers. Do not handle oil more than is necessary, always use a suitable barrier cream and PPE. Wash contaminated skin immediately in warm soapy water or proprietary cleaners.

**WARNING**



### **Safety Glasses**

Always wear safety glasses when dismantling components which may under pressure from springs.

**CAUTION**



### **Cleaning**

Cleaning parts with incorrect solvents can cause corrosion. Use only those recommended.

**CAUTION**



### **Seals & Gaskets**

Badly fitted, damaged or worn O Rings, Seals & Gaskets can cause leakage and possible accident and malfunction. Renew these whenever they are disturbed unless otherwise instructed.

**CAUTION**



### **Transmission exchanges in candidate machines**

During the unlikely event of a transmission suffering an internal failure it is probable there will be resultant debris. Such debris is likely to be transferred to the vehicles oil cooling system. It is therefore imperative that the cooling system is flushed prior to the reinstallation of any transmission.



## Care & Safety

### WARNING



### **Fluroelastomeric Materials**

Certain seals and gasket materials may contain fluroelastomeric materials such as Viton. Fluroelastomeric materials subject to high temperatures can produce highly corrosive acids.

**This acid can cause severe burns.**

New Fluroelastomeric materials at ambient temperatures will require no special safety procedures.

Used Fluroelastomeric materials whose temperature has not exceeded 300<sup>0</sup>C require no special safety precautions. If any evidence of decomposition (EG Burning or Charring ) is evident, do not touch the component or surrounding material, and refer to the following safety procedure.

Used Fluroelastomeric materials whose temperature has exceeded 300<sup>0</sup>C for example as result of a vehicle fire must be treated as follows.

Use heavy duty industrial gloves and safety glasses.

Ensure the material has cooled before removing and placing into plastic bags.

Thoroughly decontaminate the affected area with an alkaline solution (EG Calcium hydroxide) and use a scraper or wire brush to remove any burnt residue.

Thoroughly wash the area with a liquid detergent.

Seal all contaminated material including gloves etc into plastic bags and dispose of in accordance with local regulations.

**Do not incinerate**

**If contamination of the skin or eyes occurs wash continuously in clean water and seek medical help immediately.**

## Unit identification

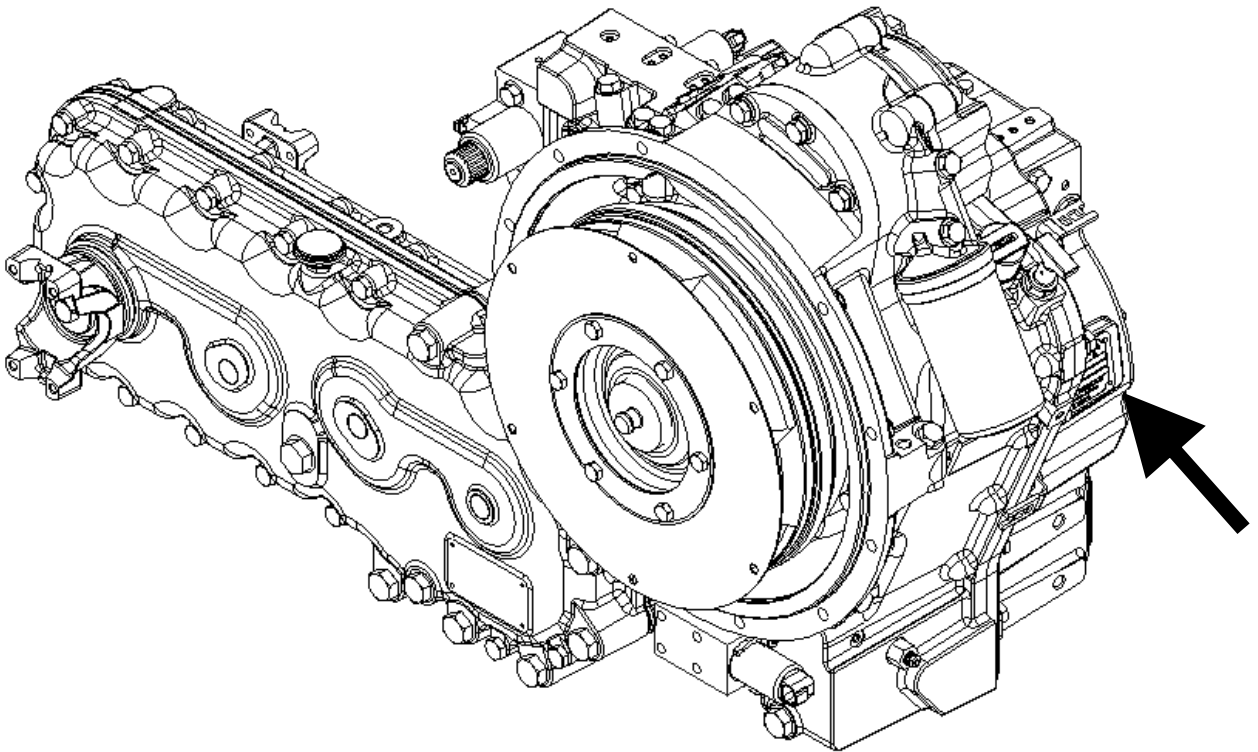

### Unit Identification

#### Transmission Serial Plate

The transmission serial number is stamped on a plate which is mounted to the side of the unit as shown in the illustration above.

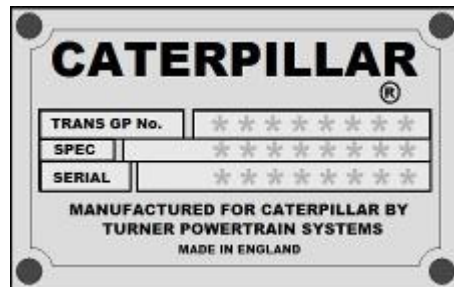

#### Replacement Parts

Always quote the serial number from the plate when ordering replacement parts.

Quote any additional detail that may be on the plate when ordering replacement parts.

# Routine Maintenance

## Service Schedule

Ensure that the regular maintenance items listed in the service schedule are undertaken to keep the transmission working in a safe and efficient manner.

All intervals are given as operational hours. If any defects are found during routine maintenance ensure these are corrected before the transmissions continued use.

Function	Operation	Interval every				
		10	50	100 *	500	1000
<b>TRANSMISSION (levels and service points)</b>						
Transmission Oil Level	Check					
Transmission Oil	Change					
Transmission Filter	Change					
<b>TRANSMISSION (functional checks)</b>						
Gear Change operation	Check					
Forward & Reverse Operation	Check					
Main Pressure	Check					
Clutch Pressures	Check					
<b>TRANSFER GEARBOX</b>						
Drive shafts	Check Security					
Drive shafts	Grease					
Transfer Gearbox Oil	Change					

\* First 100 Hours only

## Routine Maintenance

### Check Oil Level

The oil level should be checked daily and corrected if necessary.

#### *Method*

The oil level must be checked with the engine idling and with the transmission oil cold.

Withdraw the Dipstick [ **C** ] wipe clean and reinsert into the dipstick tube.

In this condition the oil level should fall between the Max and Min marks on the dipstick.

At normal operating temperature, (80°C) the oil level will rise to 20- 30 mm above the maximum mark on the dipstick.

#### **CAUTION**



Do not overfill the transmission as this may result in oil breakdown due to excessive heat and aeration from the churning action of the gears. Early breakdown of the oil will result in heavy sludge deposits that block oil ports and build up on splines and bearings. Overfilling may also cause oil leaks.

### Change Oil

An initial oil change and flush is recommended after the transmission is placed in actual service. This change should be made at any time following 50 hours in service, but should not exceed 100 hours.

An oil change and flush should be scheduled for every subsequent 1000 hours of operation.



When changing the oil it is essential to renew the oil filter

#### *Method*

Place a suitable container beneath the Oil drain plug [ **A** ], loosen the plug and drain the oil from the transmission. Examine the plug for any visible debris.

Replace the plug and refill the transmission with the correct oil quantity through the filler found beneath the breather [ **C** ]

Check the Oil level as above.

## Routine Maintenance

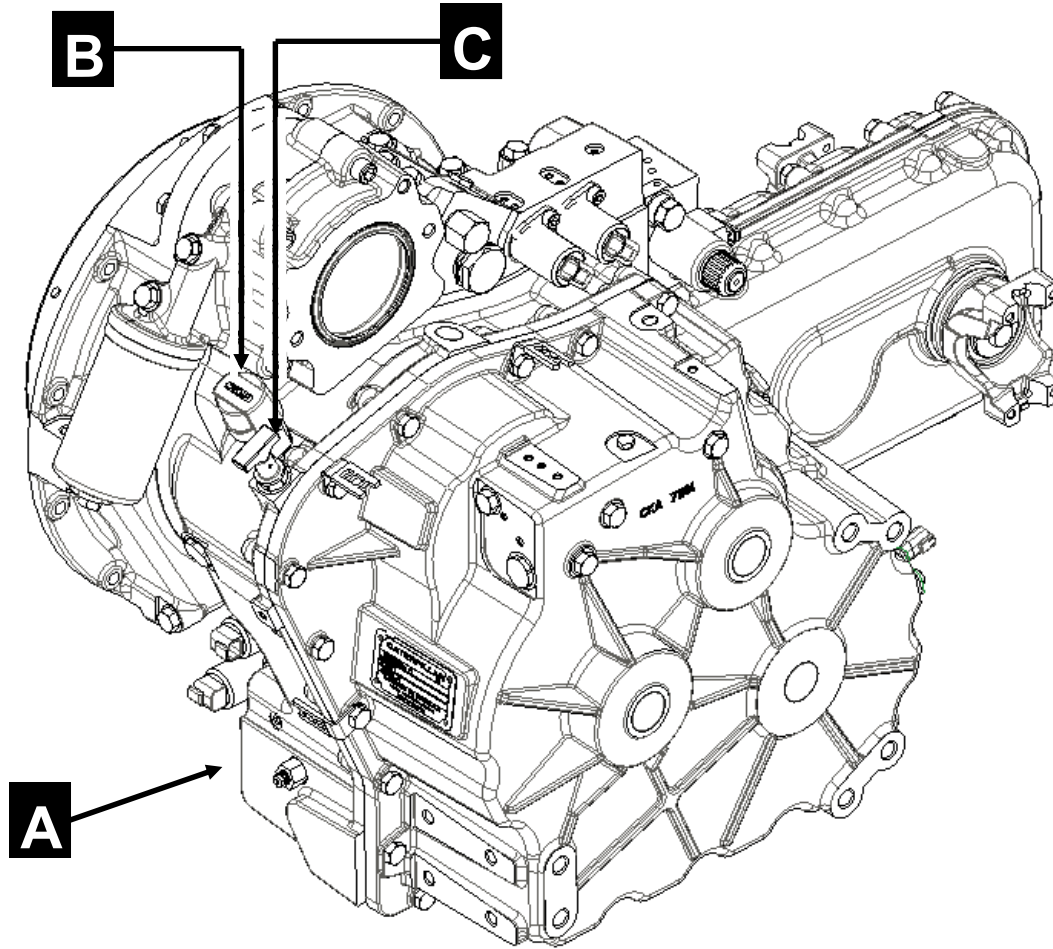

### Renew Filter

Unscrew and discard the element [ B ]

Smear the seal ring of the new element with clean transmission oil and replace.

Tighten the element by hand only, the element must be screwed on until it contacts the head and then further tightened by a minimum of 3/4 turn.

## Routine Maintenance

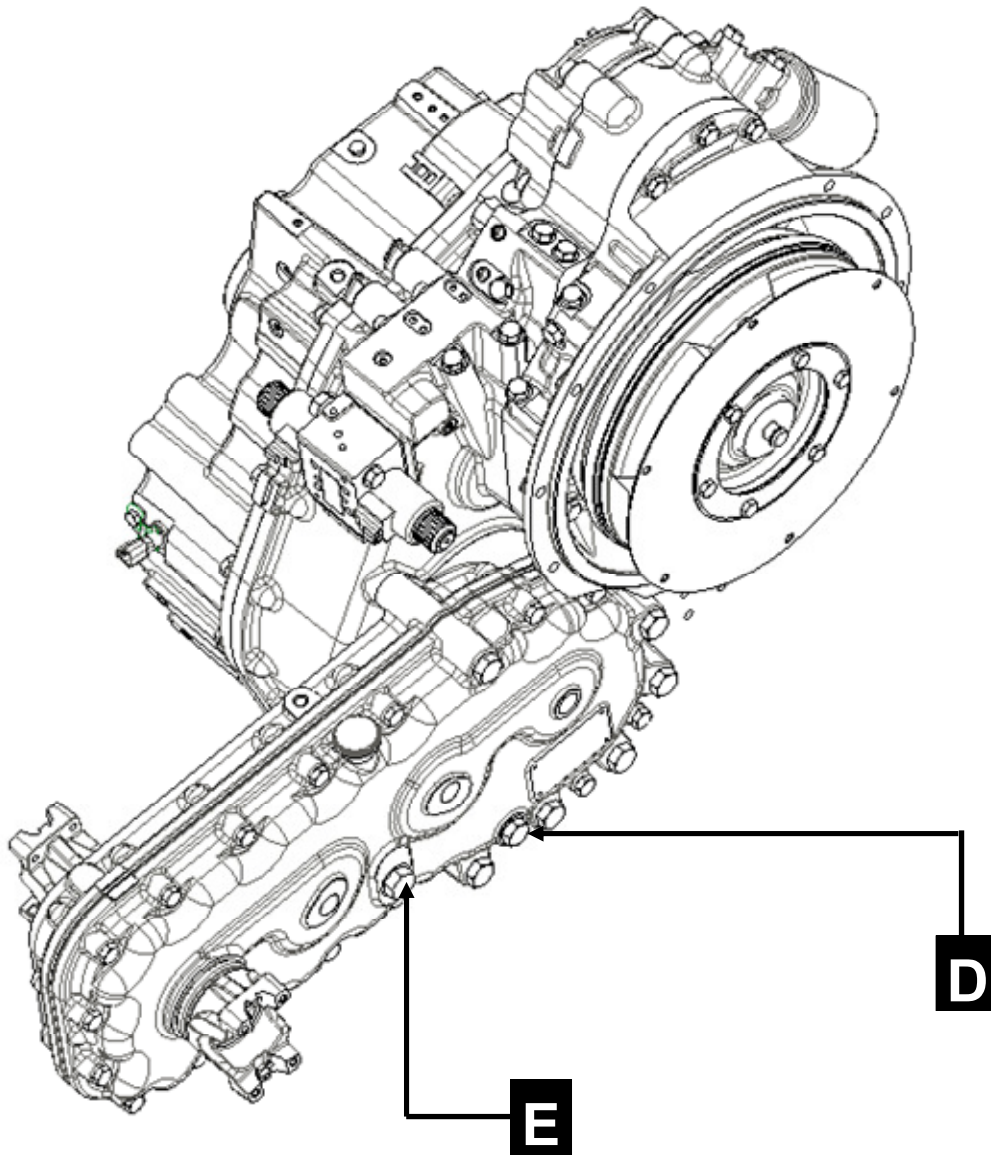

### Replace Oil

Place a suitable container beneath the transfer gearbox, remove the drain plug [ **D** ] and drain the oil into the container. Check for visible debris. Replace the plug and tighten to the specified torque.

Remove the filler plug [ **E** ] and fill with oil until level with the threads. Replace plug and tighten to the specified Torque.

## Recommended Lubricants

Caterpillar recommends 10W or 10W 30 Grade mineral oils or automatic transmission fluids which meet at least one of the following specifications are suitable for use in ambient temperatures of between –20 and 40<sup>0</sup>C: -

- A.P.I. GL4
- MIL-L-2105B
- Caterpillar T04

The following lubricants meet these requirements: -  
 (Note: This list has been compiled for guidance only. Caterpillar should be consulted on any specific application.)

SUPPLIER	TRANSMISSION FLUID
MOBIL	MOBILFLUID 424
SHELL	DONAX TA
CASTROL	TECTION MONOGRADE SAE 10W

ITEM	CAPACITY	
	Litres	US Gallons
Gearbox (excluding cooler)	16	4.25
Gearbox (including cooler)	Refer to vehicle manufacturer	
Transfer Gearbox (3 gear)	2	0.5
Transfer Gearbox (4 gear)	2.75	0.75



## Location of Test Ports

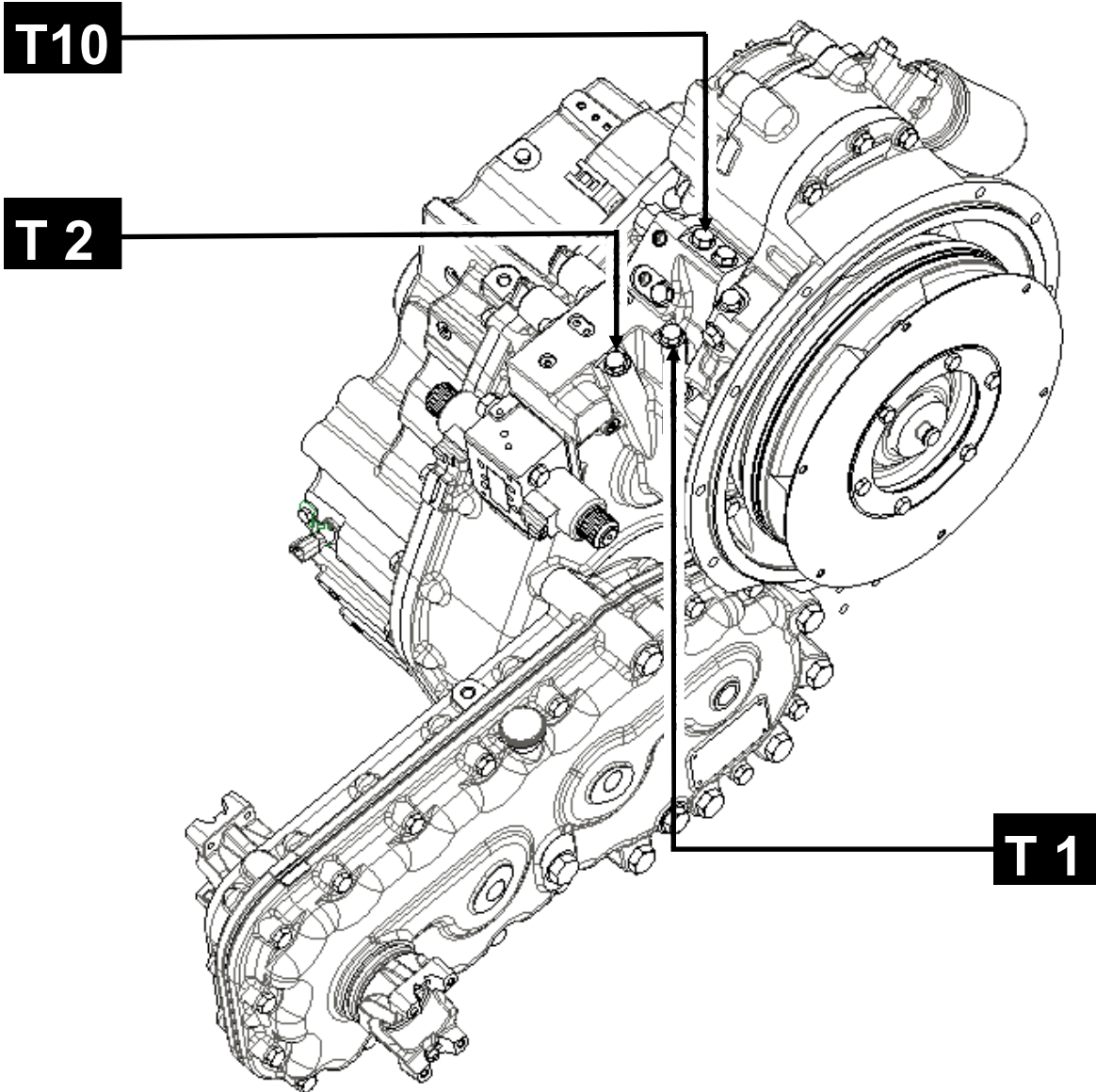

<b>T1</b>	1st Gear Clutch	9/16" - 18 UNF-2B SAE O Ring
<b>T2</b>	2nd Gear Clutch	9/16" - 18 UNF-2B SAE O Ring
<b>T3</b>	3rd Gear Clutch	9/16" - 18 UNF-2B SAE O Ring
<b>T4</b>	Forward High Clutch	9/16" - 18 UNF-2B SAE O Ring
<b>T5</b>	Forward Low Clutch	9/16" - 18 UNF-2B SAE O Ring
<b>T6</b>	Reverse Clutch	9/16" - 18 UNF-2B SAE O Ring
<b>T7</b>	Lubrication	9/16" - 18 UNF-2B SAE O Ring
<b>T8</b>	Pump (after Filter)	9/16" - 18 UNF-2B SAE O Ring
<b>T9</b>	Pump (before Filter)	9/16" - 18 UNF-2B SAE O Ring
<b>T10</b>	Converter Inlet	9/16" - 18 UNF-2B SAE O Ring



## Location of Test Ports

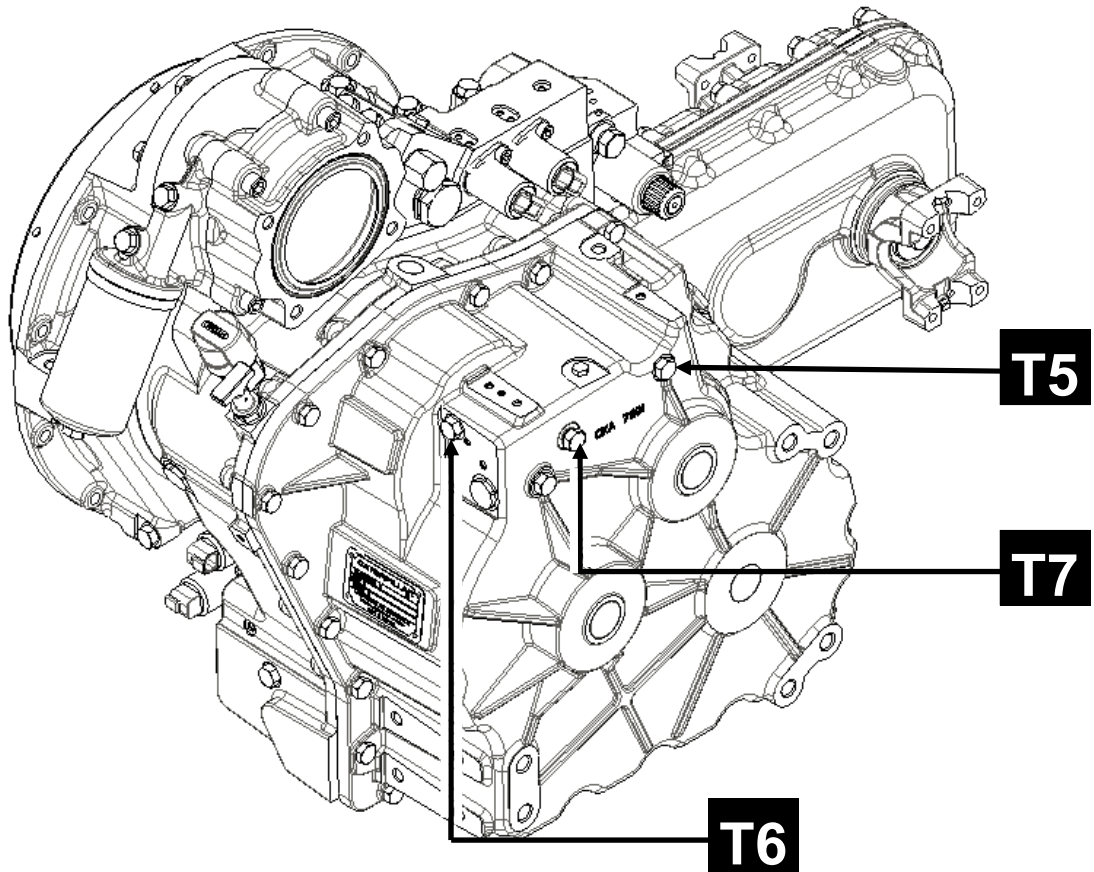
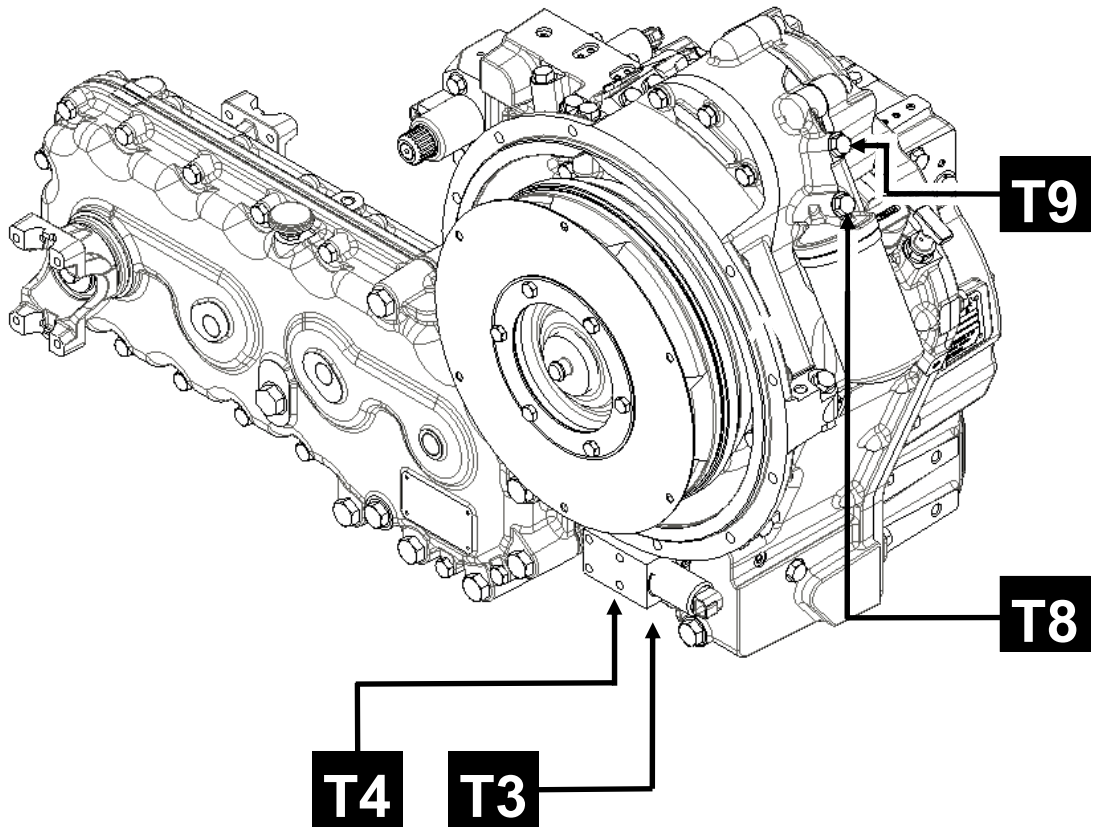

## Electrical Connections

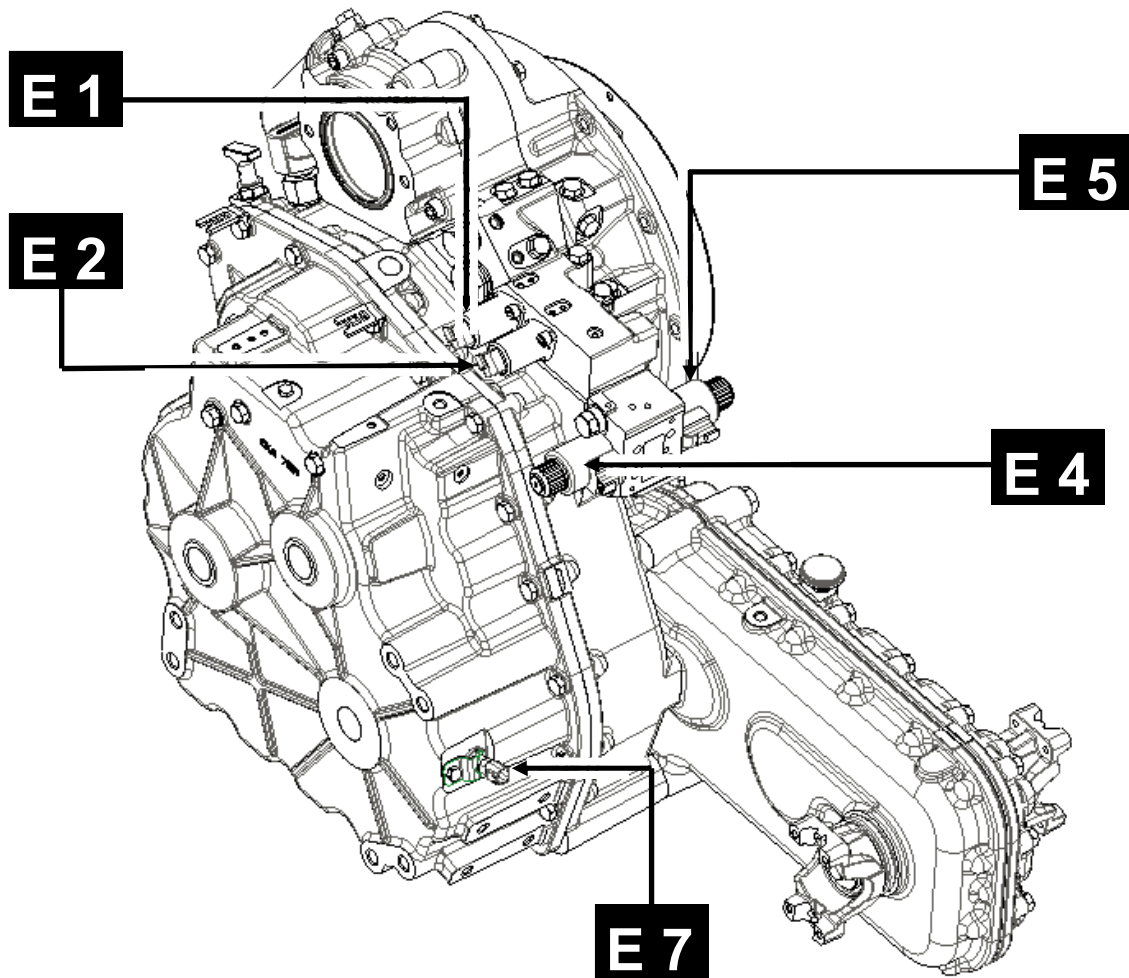

<b>E1</b>	1st Gear Clutch Solenoid	Deutsch
<b>E2</b>	2nd Gear Clutch Solenoid	Deutsch
<b>E3</b>	3rd Gear Clutch Solenoid	Deutsch
<b>E4</b>	Reverse Clutch Solenoid	Deutsch
<b>E5</b>	Forward Low Clutch Solenoid	Deutsch
<b>E6</b>	Forward High Clutch Solenoid	Deutsch
<b>E7</b>	Output Shaft Speed Sensor	Deutsch
<b>E8</b>	Temperature Sender	Ring Terminal

## Electrical Connections

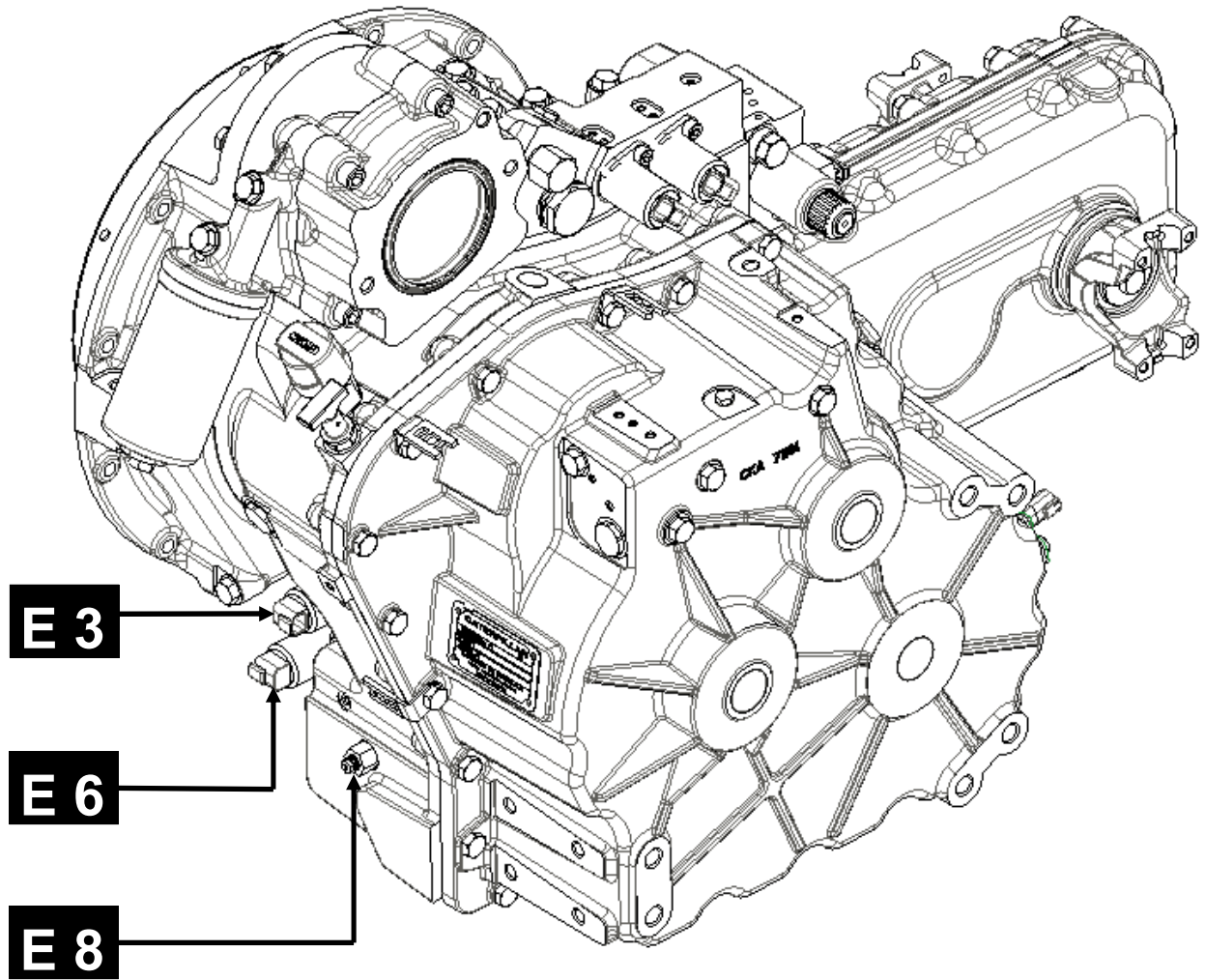

## Electrical Connections

### Solenoid Data

Waterproof Specification	IP65
Coil operating Voltage	+12V DC nominal (+/- 10%)
Power	30W
Operating temperature	160 <sup>0</sup> C at nominal voltage in 60 <sup>0</sup> C ambient
Diode protection	Yes

# Electrical Connections

## Electrical Circuit

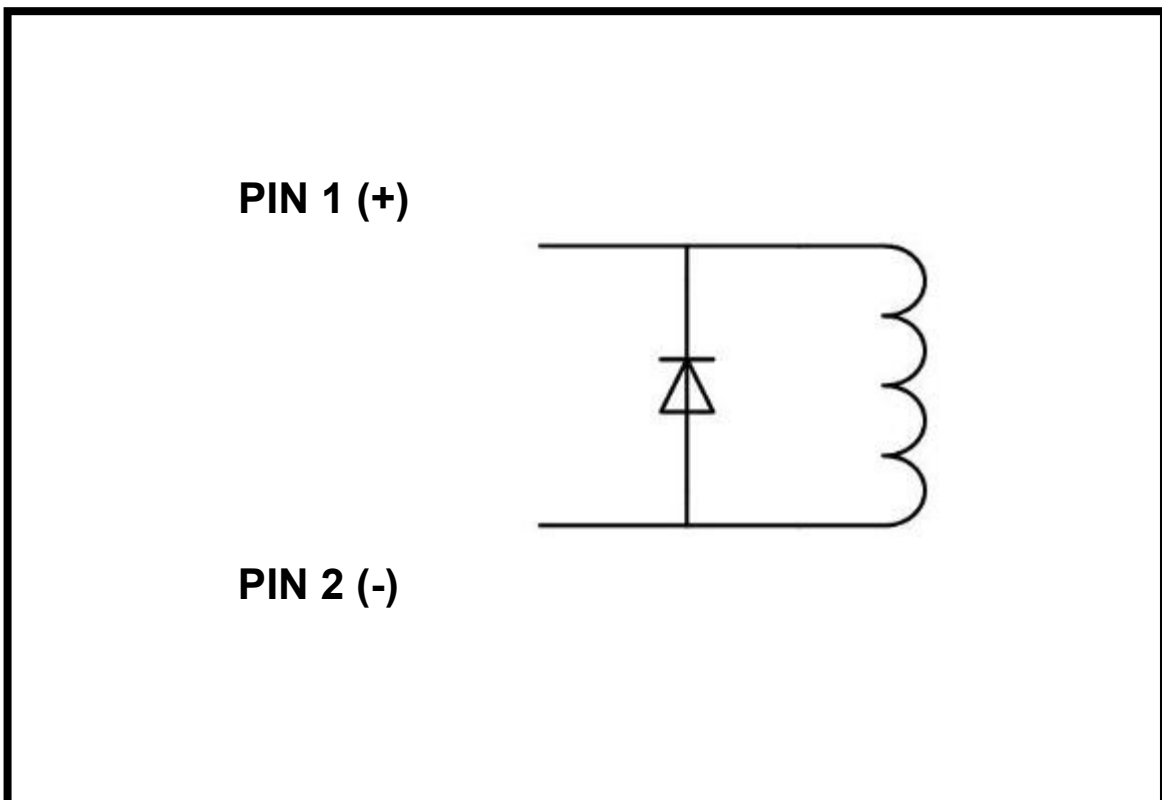
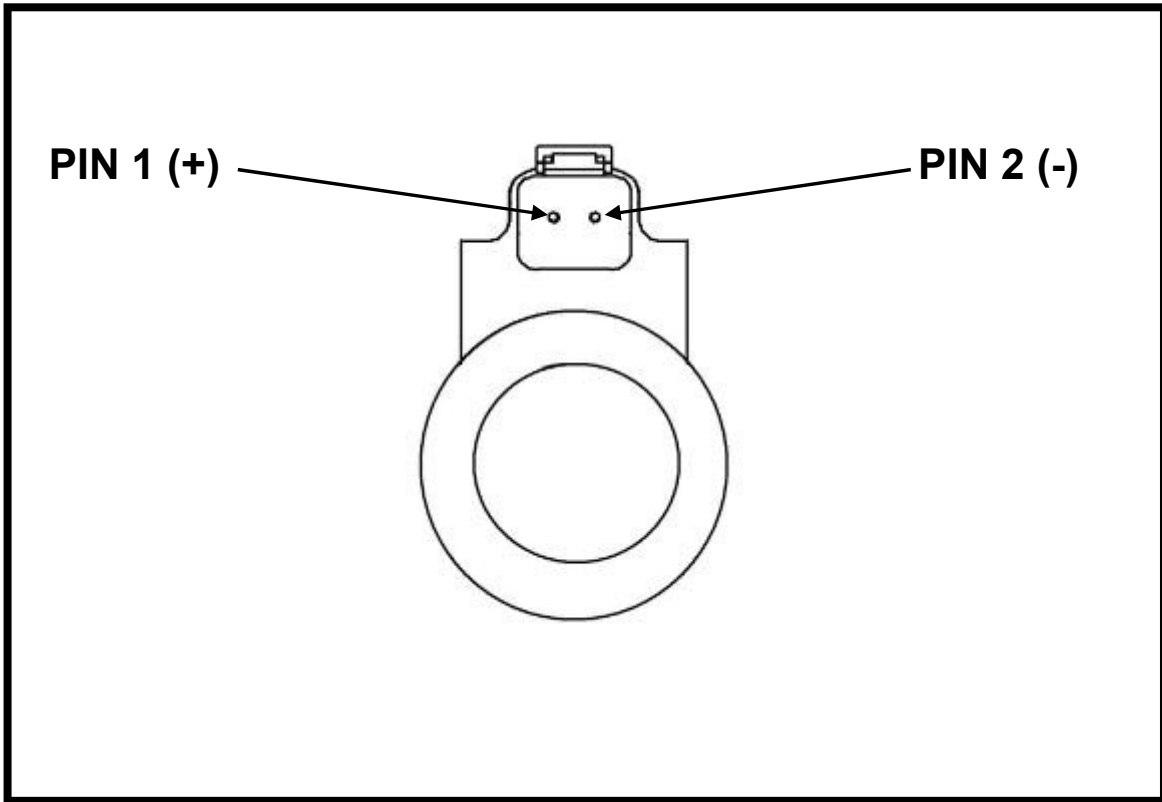

# Hydraulic Circuit

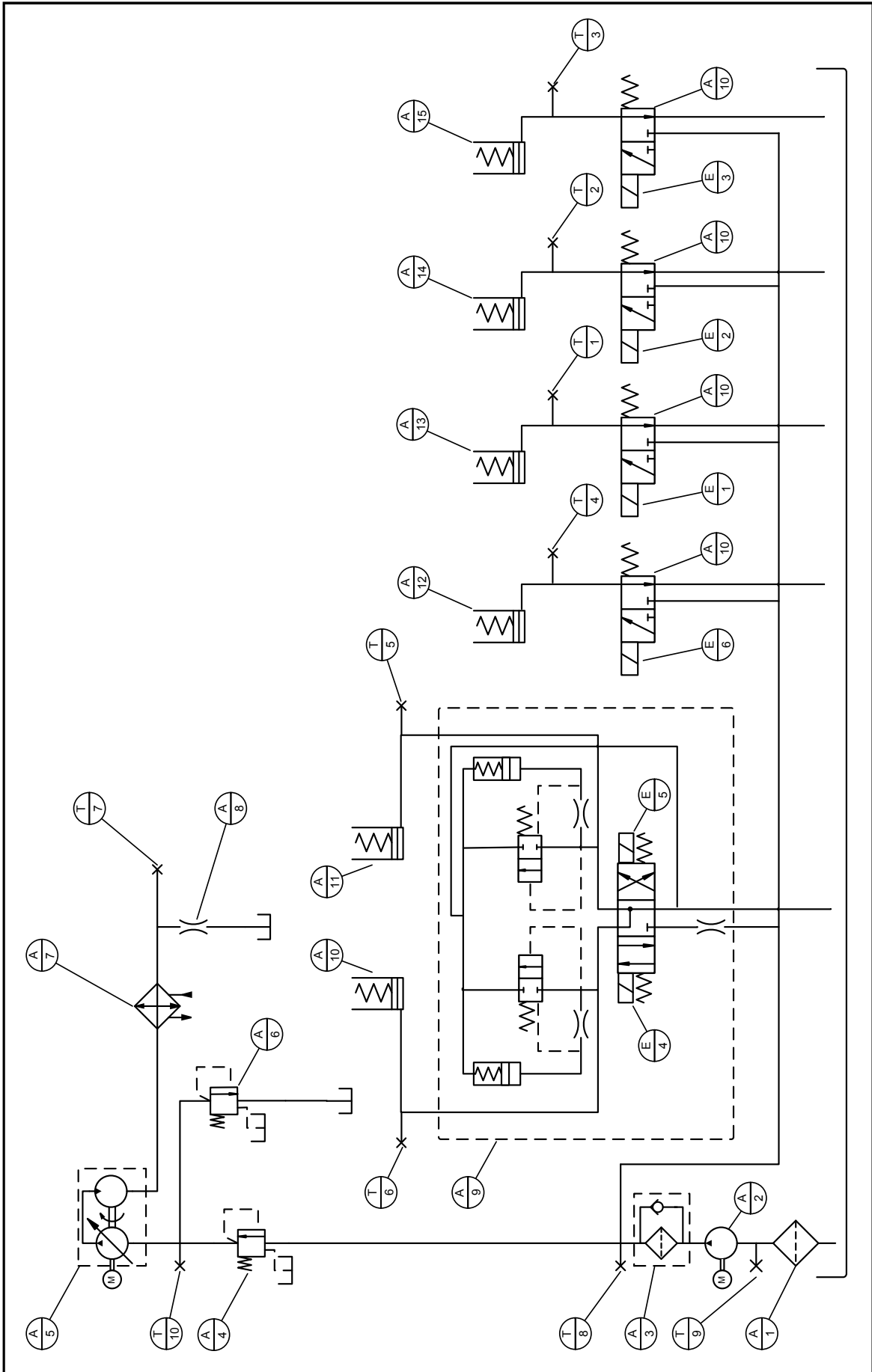

# Hydraulic Circuit

ITEM	DESCRIPTION
<b>A</b>	
1	Suction Strainer
2	Pump
3	Pressure Filter
4	Pressure Regulator
5	Torque Converter
6	Torque Converter Relief Valve
7	Oil Cooler
8	Restrictor
9	Directional Control Valve with Modulation
10	Forward Low Clutch
11	Reverse Clutch
12	Forward High Clutch
13	First Clutch
14	Second Clutch
15	Third Clutch
M	Engine
<b>E</b>	
1	First Clutch Control Solenoid
2	Second Clutch Control Solenoid
3	Third Clutch Control Solenoid
4	Reverse Control Solenoid
5	Forward Low Control Solenoid
6	Forward High Control Solenoid
<b>T</b>	
1	Pressure Test Point - First Clutch
2	Pressure Test Point - Second Clutch
3	Pressure Test Point - Third Clutch
4	Pressure Test Point - Forward High Clutch
5	Pressure Test Point - Forward Low Clutch
6	Pressure Test Point - Reverse Clutch
7	Pressure Test Point - Cooler Outlet
8	Pressure Test Point - Mainline Pressure
9	Pressure Test Point - Pump
10	Pressure Test Point - Torque Converter relief

## Connections

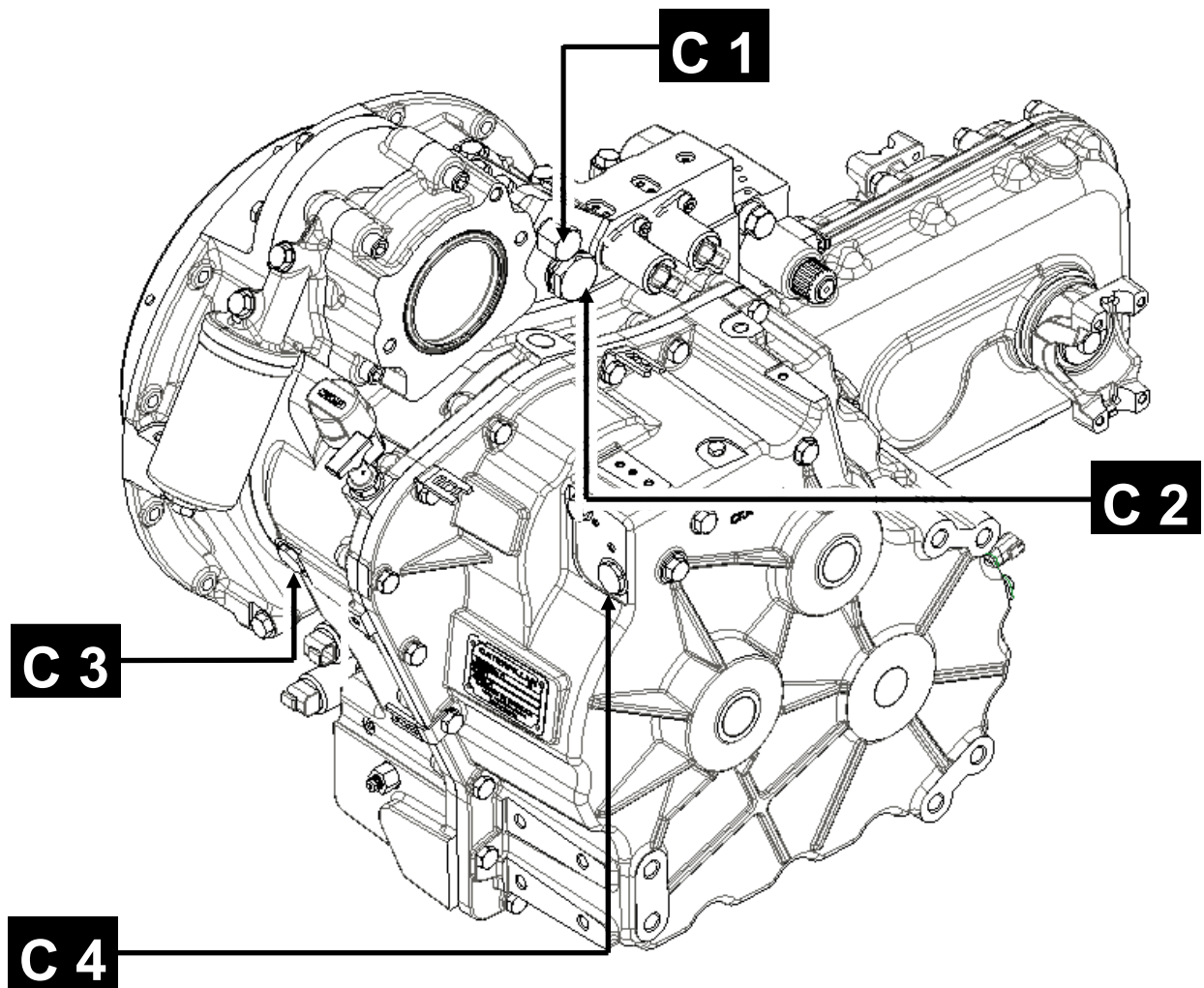

<b>C1</b>	Relief Valve	M22 X 1.5
<b>C2</b>	Pressure Regulator	M33 X 2.0
<b>C3</b>	Cooler Outlet	7/8" - 14 UNF 2B SAE O Ring
<b>C4</b>	Cooler Return	7/8" - 14 UNF 2B SAE O Ring



## Method Of Operation

### 4 SPEED MODELS - TH417 & TH514

Gear	Clutch Engaged		Solenoid(s) Active	
Forward				
1st	Forward Low	Clutch One	E5	E1
2nd	Forward Low	Clutch Two	E5	E2
3rd	Forward Low	Clutch Three	E5	E3
4th	Forward High	Clutch Three	E6	E3
Reverse				
1st	Reverse	Clutch One	E4	E1
2nd	Reverse	Clutch Two	E4	E2
3rd	Reverse	Clutch Three	E4	E3

### 4 SPEED MODELS - TH336, TH337, TH406, TH407 & TH414

Gear	Clutch Engaged		Solenoid(s) Active	
Forward				
1st	Forward Low	Clutch One	E5	E1
2nd	Forward Low	Clutch Two	E5	E2
3rd	Forward High	Clutch Two	E6	E2
4th	Forward Low	Clutch Three	E5	E3
Reverse				
1st	Reverse	Clutch One	E4	E1
2nd	Reverse	Clutch Two	E4	E2
3rd	Reverse	Clutch Three	E4	E3

## Method Of Operation

### 6 SPEED MODELS - TH336, TH337, TH406 & TH407

Gear	Clutch Engaged		Solenoid(s) Active	
<b>Forward</b>				
1st	Forward Low	Clutch One	E5	E1
2nd	Forward High	Clutch One	E6	E1
3rd	Forward Low	Clutch Two	E5	E2
4th	Forward High	Clutch Two	E6	E2
5th	Forward Low	Clutch Three	E5	E3
6th	Forward High	Clutch Three	E6	E3
<b>Reverse</b>				
1st	Reverse	Clutch One	E4	E1
2nd	Reverse	Clutch Two	E4	E2
3rd	Reverse	Clutch Three	E4	E3

## Method Of Operation

This page is left intentionally blank

## Method Of Operation

### The Clutch Circuit (Refer to schematic P18)

Oil from the transmission sump is drawn up through the suction strainer [A1] by the pump.[A2]

It is forced, under pressure from the pump, through the full flow oil filter [A3] into the clutch circuit.

The clutch circuit pressure is regulated by a relief valve [A4] This maintains the clutch system pressure between 13.0 and 17.5 bar.

From this valve oil also enters the torque converter circuit.

From the filter the oil flows to the Modulated directional control valve [A9] and the individual clutch control valves [ A12,13,14 & 15]

Six solenoid actuated control valves, two on the dual modulated valve [E4 & E5] and one on each individual control valve [ E1,E2,E3 & E6] are used to send oil from the clutch circuit to the six clutch packs. The clutch packs are referred to as Forward High [A12] , Forward Low [A10] , Clutch 1[A13], Clutch 2 [A14], Clutch 3 [A15] and Reverse[A11]

For each gear selected two solenoids are actuated and two clutch packs are engaged. (Refer to P21 for details.)

When deselected the solenoid valves close and oil from the clutch packs is returned to the sump.

### The Torque Converter Circuit

Oil enters the converter circuit from the main pressure regulator valve [A4]. It flows through passages in the oil pump housing and in to the torque converter [A5].

Pressure is controlled by the converter relief valve [A6], which prevents the Pressure within the torque converter from exceeding the design limits. (7 to 10 bar depending on the type of converter used.)

Any excess is returned to the sump.

### The Cooling and Lubrication Circuit

Hot oil flows from the torque converter via the inside of the pump stator tube, through the centre of the oil pump, and out of the transmission via connecting hoses.

It is then passed through an external oil cooler [A7] before being returned to the transmission represented by the restrictor [A8] where it is used to cool the clutches and lubricate the input shaft bearings before being returned to the sump.



A number of pressure test points are provided on the transmission casing. These are closed by a blanking plugs. See pages 12 and 13 for the location of each

## Torque Converter Installation

In order to ensure correct installation of the torque converter the following procedure is recommended: -

1. Attach a dial indicator to the engine flywheel and check that the run-out of the flywheel housing bore diameter and the housing mounting face are within 0.203 mm (0.008") T.I.R.  
With the dial indicator attached to the flywheel housing, check that the run-out of the flywheel pilot bore does not exceed 0.127 mm (0.005") T.I.R.
2. Loosely assemble the drive plate to the converter.  
Check that the outer bolt circle of the drive plate is concentric to the converter pilot diameter within 0.381 (0.015") T.I.R.  
Then torque the bolts to the manufacturers specification.
3. Apply an anti-seize compound to the pilot diameter of the converter.
4. Ensure that the converter drive tangs are correctly aligned with the transmission pump tangs, then assemble the torque converter and drive plate assembly onto the transmission.

**CAUTION**



Take care not to damage the pump oil seal or support bush.

Rotate the converter assembly to check that it is correctly engaged in the pump.

5. Assemble the transmission and converter assy. onto the engine and tighten the bell housing bolts.

Loosely fit the drive plate to flywheel bolts and rotate the converter several times to seat it, and then torque the bolts to the manufacturers specification.



If this procedure cannot be followed, due to the absence of an access hole in the flywheel housing, then the converter and drive plate assembly will have to be fitted to the engine first.

This method however is not recommended as the possibility of damaging the transmission pump or oil seal is greatly increased.

If this method must be used then the following check should be made: -

With the converter fitted to the engine attach a dial indicator to the flywheel housing and check that the run-out of the converter drive hub does not exceed 0.203 mm (0.008") T.I.R.

## Technical Data

### Torque Converter Data

Type			
	Test Port	bar	lbf/in <sup>2</sup>
<b>Converter pressures (neutral)</b>			
Converter inlet relief pressure (max)			
Converter at High idle	T10	7 - 10	101 - 145
<b>Lubrication pressures (neutral)</b>			
At Low idle		0.5 - 1.5	7 - 22
At High idle		2 - 3.5	29 - 51
<b>Main Pressure</b>			
At Low idle	T9	14 - 16	203 - 232
At High idle	T9	15.5 - 17.5	224 - 253
<b>Clutch Pressure(s)</b>			
At High idle	T1-T6	12 - 15	174 - 218

All figures assume an operating temperature of 80 C ( 175 F )

# Technical Data

**MODELS - TH417 & TH514**

**CAT 363-3033**

NB - All ratios are overall and include transfer gearbox

Gear	Ratios	
	Forward	Reverse
1st	4.87	4.87
2nd	2.48	2.48
3rd	1.06	1.06
4th	0.71	-----

**MODELS - TH336, TH337, TH406, TH407 & TH414**

**CAT 363-3034**

NB - All ratios are overall and include transfer gearbox

Gear	Ratios	
	Forward	Reverse
1st	3.59	3.59
2nd	1.83	1.83
3rd	1.22	0.78
4th	0.78	-----

**MODEL - TH336, TH337, TH406 & TH407**

**CAT 316-1940 & 363-3035**

NB - All ratios are overall and include transfer gearbox

Gear	Ratios	
	Forward	Reverse
1st	3.94	3.94
2nd	2.63	2.01
3rd	2.01	0.86
4th	1.34	-----
5th	0.86	-----
6th	0.57	-----

**Towing**

**CAUTION**



To prevent oil starvation and possible seizure of the transmission whilst towing the vehicle, it is imperative that the propeller shafts are disconnected.

**Failure to observe this precaution may result in extensive damage to the transmission.**

## Technical Data

<b>Bolt Torque Recommendations (Specific)</b>		
<b>Location</b>	<b>Torque</b>	
	<b>Nm</b>	<b>lb ft</b>
Transfer Gear box Casing	45 - 64	33 - 47
Transfer Gearbox Yokes	68 - 88	50 - 65
Reverse Idler Gear	68 - 88	50 - 65
Stator Support Hub	18 - 31	13 - 23
Torque Converter Housing	45 - 64	33 - 47
Pump Assembly	18 - 31	13 - 23
Pump Housing	63 - 88	50 - 65
Transfer Tube	18 - 31	13 - 23
Rear Casing	45 - 64	33 - 47
Dual Modulating Valve	7 - 10	5 - 7.5
Speed Sensor	18 - 31	13 - 23
Solenoid Valve clamp bolts	18 - 31	13 - 23
Forward / High Clutch Valve Assembly	7 - 10	5 - 7.5
Converter relief valve	23 - 30	17 - 22
Main Pressure Regulator	45 - 64	33 - 47
Transfer gearbox to main casing	200 - 280	148 - 206



# Technical Data

## Recommended Sealants

Location	Sealant
Transfer Gearbox Casing	Loctite 5203
Output shaft gear	Loctite 638
Transmission casing Joint	Loctite 5203
Expansion Plugs	Loctite 574

## Tightening Sequences

### Pump

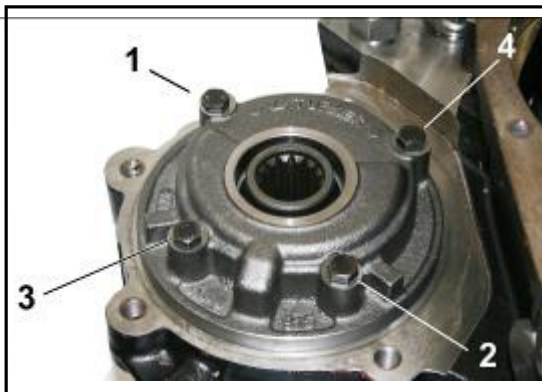

### Dual Modulating Valve

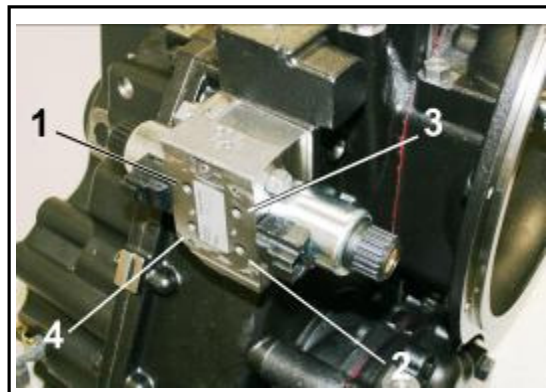

# Technical Data

## Lifting Point Location

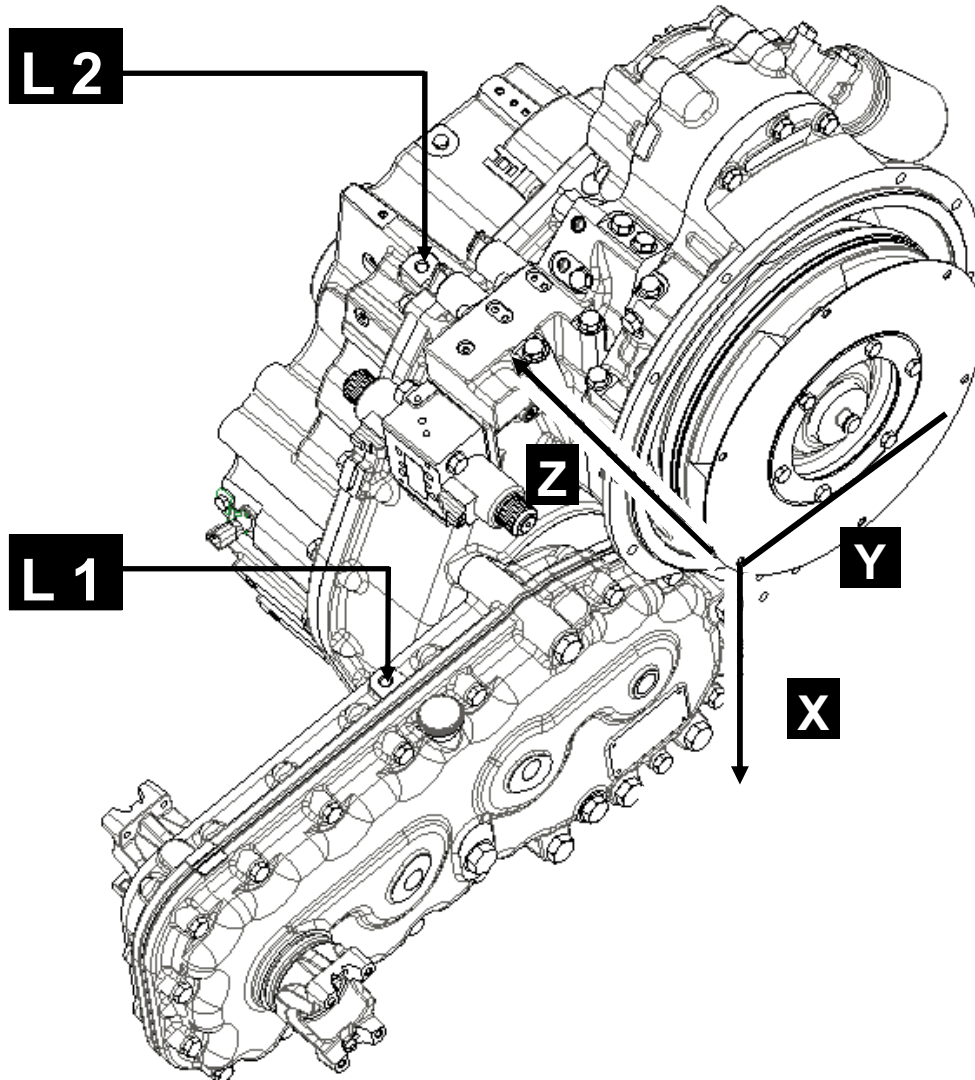

## Lifting Transmission & Transfer Gearbox Assembly

CAUTION



The information given is for the Transmission assembly and transfer gearbox only. Removal from a vehicle may mean that the Engine & Transmission are removed as an assembly. Refer to the vehicle manufacturers information for detailed instruction.

The transmission lifting points are located as follows:-

- L1 on the upper side of the rear Transfer gearbox housing
- L2 on the upper side of the rear casing adjacent to the clutch solenoids
- L3 on the front casing between the Bell housing and Oil filter

# Technical Data

## Lifting Point Location

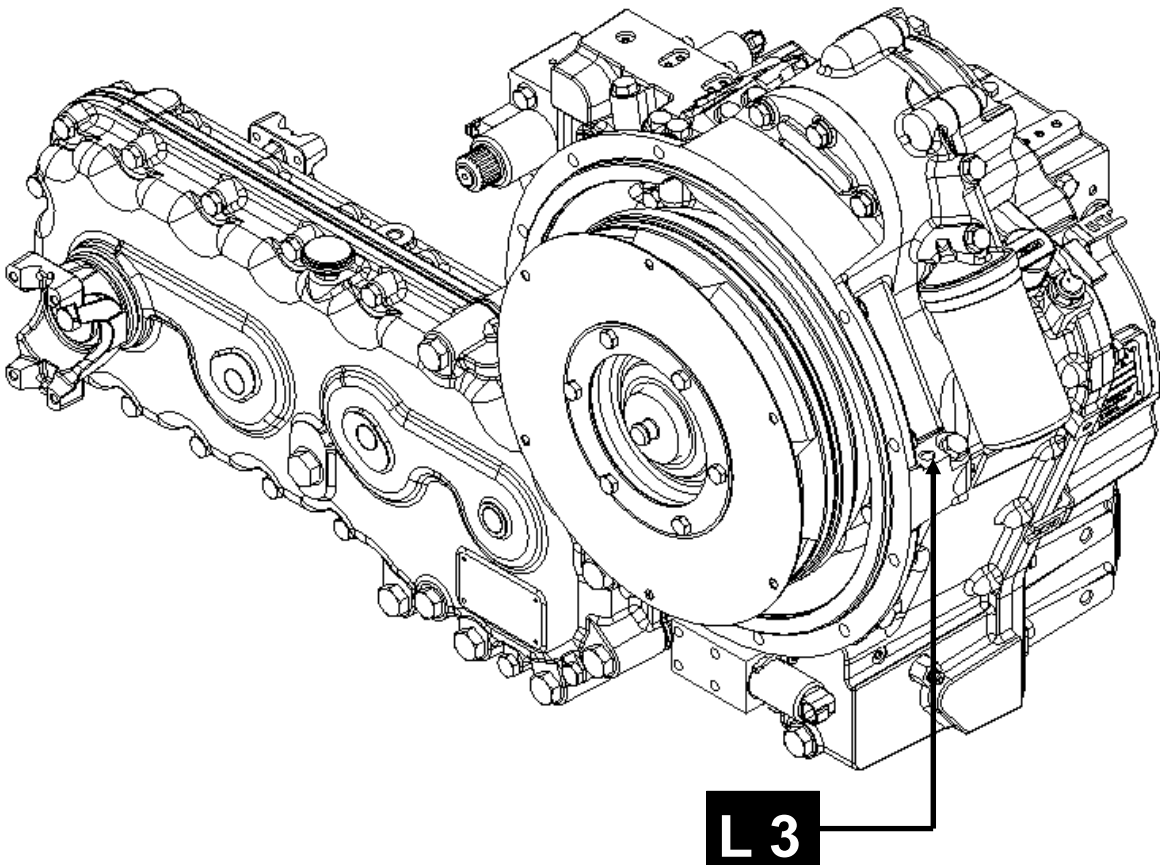

<b>L1</b>	M12 X 1.75 X 26 deep	30mm Dia. spotface
<b>L2</b>	M12 X 1.75 X 26 deep	30mm Dia. spotface
<b>L3</b>	M12 X 1.75 X 26 deep	30mm Dia. spotface
<b>Centre of Gravity</b>		
	3 Gear Transfer Case	4 Gear Transfer Case
<b>X</b>	93 mm	110 mm
<b>Y</b>	152 mm	166 mm
<b>Z</b>	171.5 mm	112.5 mm

## Technical Data

### Lifting Transmission & Transfer Gearbox Assembly

CAUTION



Ensure all lifting equipment is suitable and safe to use, and conforms to local legislative requirements before commencing. Failure to do so may result in personal injury or damage to the Transmission assembly

Attach suitable lifting shackles to the three lift points L1, L2 & L3 as shown in the previous illustration.

<b>WEIGHT</b>	<b>Kg</b>	<b>lbs</b>
<b>MODELS - All 4 speed</b> CAT - 363-3033 & 363-3034	312	688
<b>MODELS - All 6 speed</b> CAT - 316-1940, 363-3035	329.5	726

Attach a suitable Three legged chain (with chain length adjusters) to each lift shackle and take the weight of the assembly.

Take care not to damage the Clutch solenoids in close proximity to Lift Point L2, remove them if necessary

Take care not to damage the Oil filter assembly in close proximity to L3 , remove it if necessary.

Recheck the chain lengths to ensure the best possible lift position.

Check all ancillary connections are removed

Raise the assembly

CAUTION



If removing the assembly to a bench ensure it is securely restrained and chocked with wooden blocks etc before removing the assembly from the crane.

## Technical Data

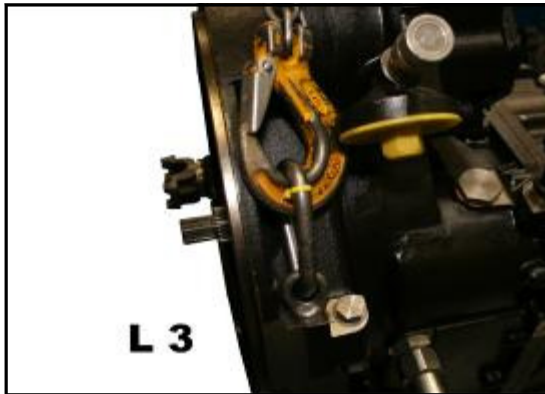
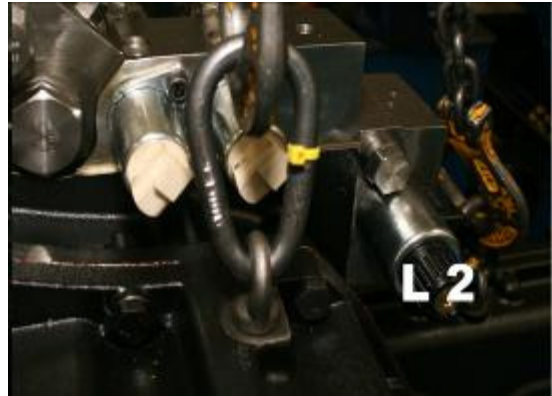

**This page is left intentionally blank**

## Transfer Gearbox Removal



1:1 Place the Transmission Assembly on a suitable surface and support as required.



1:2 Remove the 6 Bolts that connect the Transfer Case assembly to the Transmission Housing.



1:3 With the bolts removed support the Transfer Gearbox assembly and insert a suitable lever as shown between the Transfer gearbox and main casing.

Remove the Transfer Gearbox from the main casing. Take care not to damage the seal on the main gearbox output shaft.



Replacement is the reversal of the removal procedure

Refer to Technical Data (Page 26) for Torque settings

**This page is left intentionally blank**



## Transfer Gearbox Disassembly



2:1 Remove the Transfer Gearbox from the main transmission casing (see page 29) All versions of the transfer gearbox are dismantled using the same method.



2:2 Remove the breather assembly from the casing.



2:3 Support the transfer gearbox and loosen the retaining screw for the front and rear drive yokes.



2:4 Remove the retaining screw and washer for the front drive yoke.



2:5 Remove the O ring seal.



2:6 Remove the Front yoke from the splined shaft.

## Transfer Gearbox Disassembly



2:7 Remove the Spacer.  
Repeat Steps 2.3 to 2.7 For the rear drive yoke



2:8 Support the Transfer gearbox assembly and remove the 12 casing bolts.



2:9 Use a lever to separate the casing halves



2:10 Lift the front casing from the rear.



2:11 The Transfer gearbox assembly with the front case removed.



2:12 Remove the Output shaft assembly.

## Transfer Gearbox Disassembly



2:13 Remove the intermediate gear assembly.



2:14 Remove the Input gear assembly.



2:15 Remove & retain the bearing cups and shims from the rear casing & the bearing cups from the front case.



2:16 Using a suitable tool remove and discard the oil seal from the output shaft. Repeat for the front case.



2:17 Using a suitable tool remove and discard the oil seal from the input shaft.

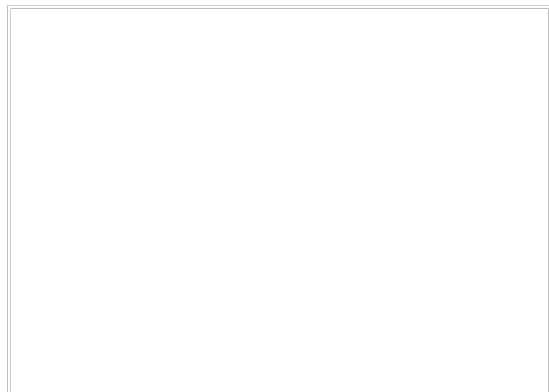

## Transfer Gearbox Disassembly



2:18 Use a suitable puller to remove the bearings from the gear shafts



2:19 Install the shaft in a suitable press to remove the gear from the shaft.

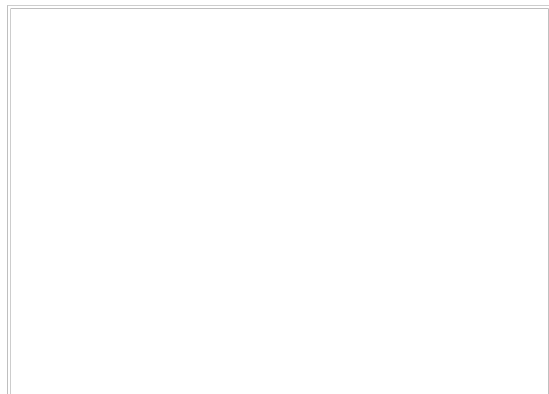
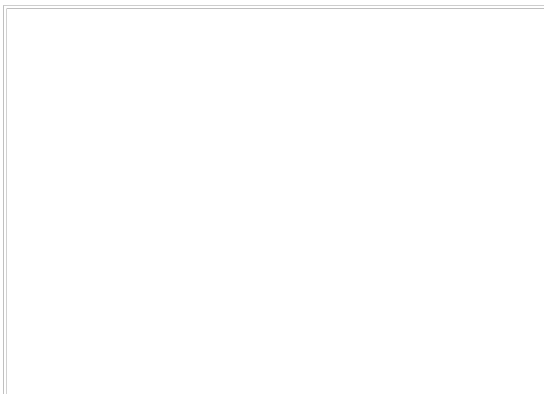
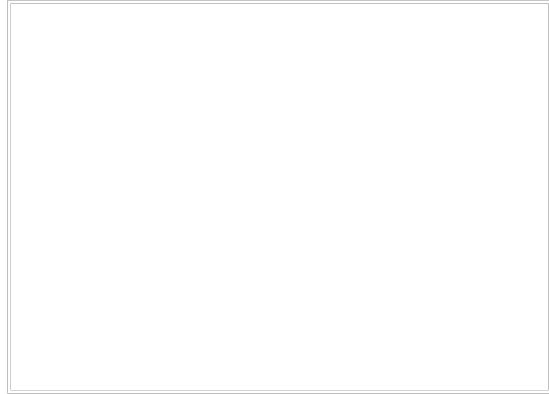
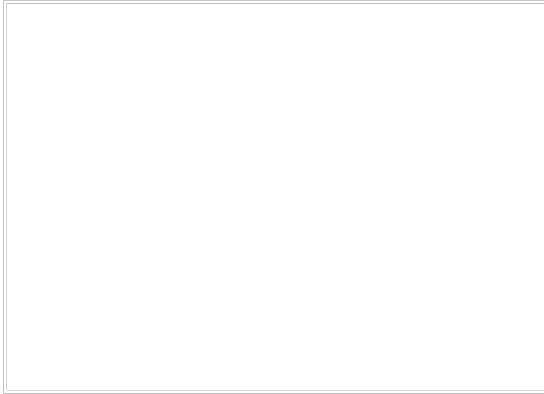



## Transfer Gearbox Reassembly



3:1 Using a suitable tool install the input shaft oil seal.



3:2 Using a suitable tool install the output shaft oil seal to the rear casing. Repeat for the front casing.



3:3 Using a suitable tool install the bearing cups into the front and rear casing. **DO NOT** install shims at this stage.



3:4 Drive out and discard the shimming plugs from each shaft on the rear casing.

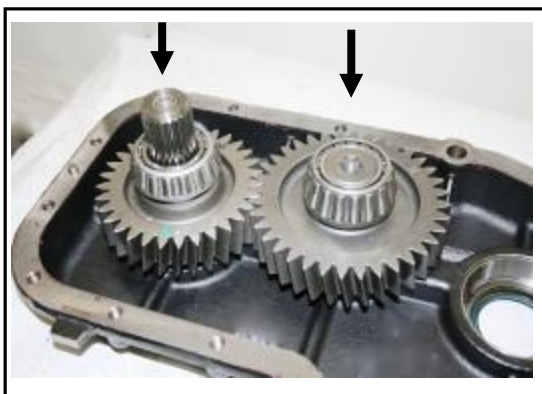

3:5 Reinstall each of the gear shafts into the rear casing. Ensure the threaded holes (arrowed) are uppermost.



3:6 Remove any sealant from the casing halves. Fit the front casing and tighten the bolts equally to the correct torque.

## Transfer Gearbox Reassembly

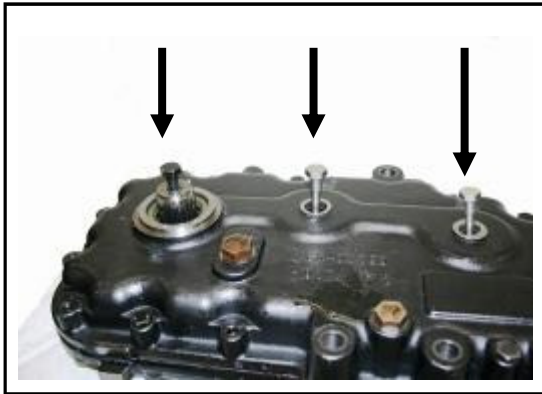

3:7 Install a suitable Bolt to each of the threaded holes in the end of the gear shafts.



3:8 Install a Dial test indicator to measure the endfloat in each shaft. Set the indicator to zero.



3:9 Using a suitable bar and pivot block apply pressure to the bolt and record the amount of movement (endfloat) for each shaft.



3:10 Remove the front casing.



3:11 Remove the shaft assemblies and bearing cups from the rear case.

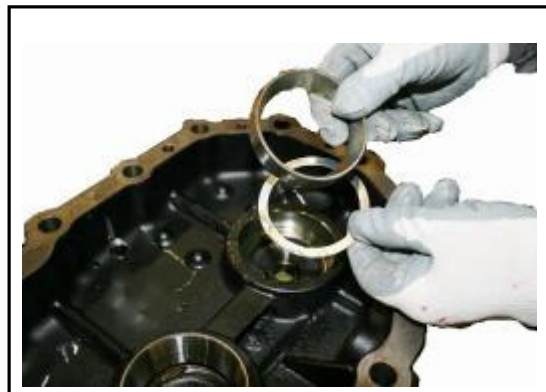

3:12 Calculate the required shim size to give the correct endfloat for each shaft and install shims behind each bearing cup.

## Transfer Gearbox Reassembly



3:13 Reinstall each of the gear shafts



3:14 Fit the front casing and tighten the bolts equally to the correct torque.

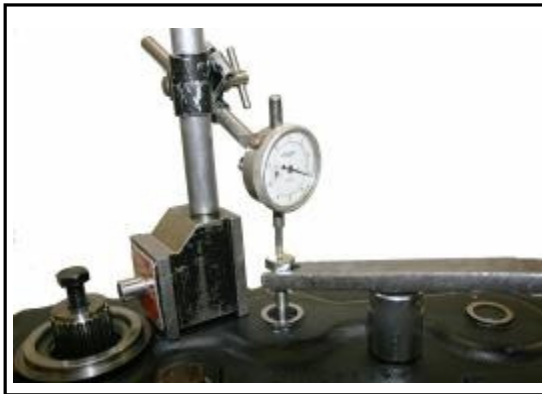

3:15 Recheck the endfloat for each shaft. Repeat steps 3.8 to 3.14 Until the correct endfloat is achieved.  
 $+0.0254$  to  $+0.0762\text{mm}$  ( $+0.001''$  to  $+0.003''$ )



3:16 Apply sealant to the mating faces of the front and rear casing.

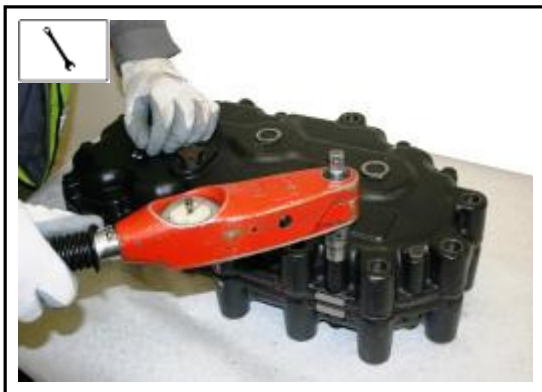

3:17 Fit the front casing and tighten equally to the correct torque.  
 $45 - 64 \text{ Nm}$  ( $33 - 47 \text{ lb ft}$ )



3:18 Insert replacement shimming plugs to each shaft.

## Transfer Gearbox Reassembly



3:19 Install the spacers to the front and rear shafts.



3:20 Install the front and rear drive yokes.



3:21 Install O ring seals to each yoke



3:22 Install the retaining bolts and washers to each yoke. Tighten to the correct torque.  
63 - 88 Nm ( 50 - 65 lb ft)



3:23 Reinstall the breather assembly to the casing.

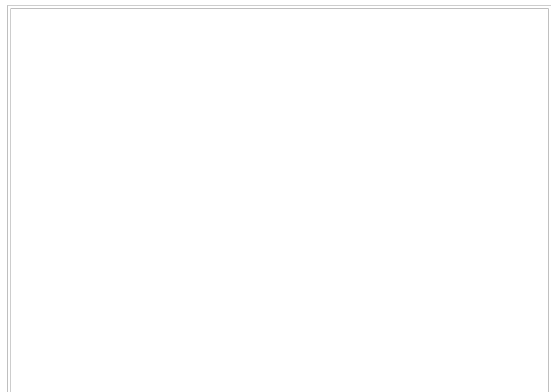



## Method Of Operation

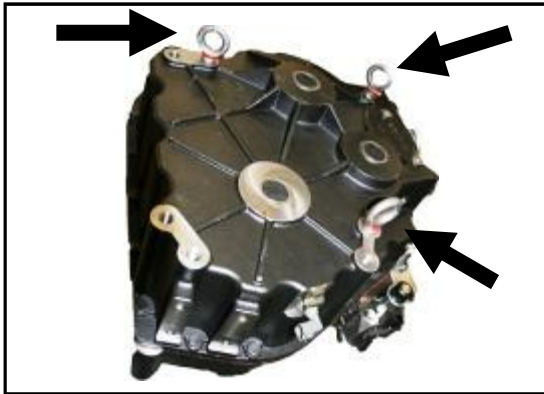

4:1 Fit suitable lifting equipment to the rear casing of the transmission.

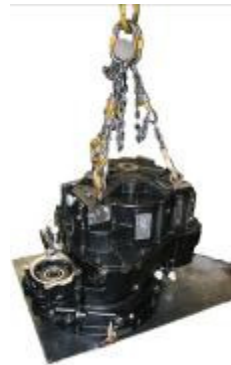

4:2 Invert the transmission on a suitable bench. For safety and convenience the bench should have hole in it to accommodate the input shaft and reaction shaft.



4:3 Remove the 4 plastic plugs and cap screws, and remove the Dual modulating valve.

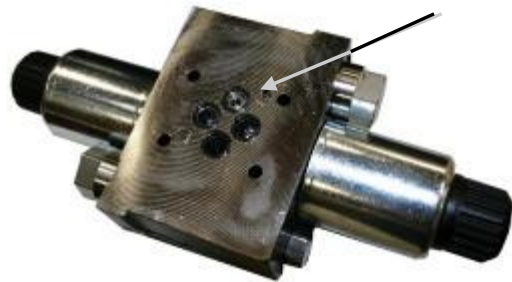

4:4 Remove the 4 O Ring seals from the Dual modulating valve.



4:5 Remove the Clamp Bolt and retaining clamp and remove the Speed sensor from the transmission.



4:6 Remove the Cap screw and clamp from each of the clutch solenoid valve assemblies

## Method Of Operation



4:7 Prise out the Solenoid valve assemblies from the Transmission Casing



4:8 Remove the Relief valve cartridge



4:9 Remove the Main Pressure regulator valve cartridge

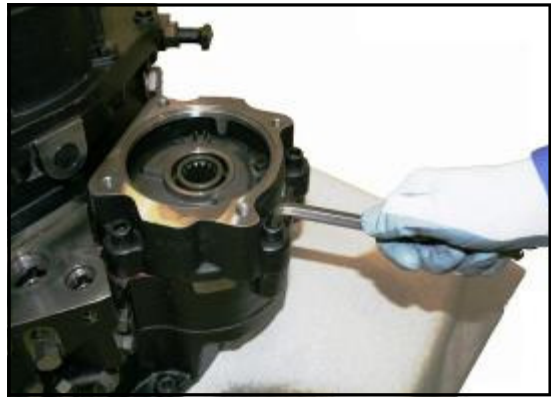

4:10 Remove the 4 capscrews that secure the Pump housing to the Main transmission casing.



4:11 Lift the Pump housing away from the pump.



4:12 Remove the 4 Bolts that secure the pump to the Main transmission casing

## Method Of Operation



4:13 Remove the Pump assembly from the transmission and recover the O ring seal



4:14 Remove the 20 Screws securing the casing.



4:15 Using suitable lifting equipment remove the rear transmission case. Lever slots are provided to assist removal. Caution! The bearing Cups and shims may fall from the case during removal



4:16 The Transmission with the rear casing removed.



4:17 Lift and remove the Output shaft assembly.



4:18 Remove the Screw and Washer from the end of the Forward High / Third clutch shaft.



## Method Of Operation



4:19 Fit a suitable lifting eye to the Forward High / Third clutch shaft.



4:20 Lift the Forward High / Third clutch shaft out of the front casing.



4:21 Remove the Screw and Washer from the end of the 1st / 2nd clutch shaft and fit a suitable lifting eye.



4:22 Lift and Tilt the 1st / 2nd clutch shaft lift out the Forward Low / Reverse Clutch Shaft (Input Shaft)



4:23 Using suitable lifting equipment remove the 1st / 2nd clutch shaft assembly.

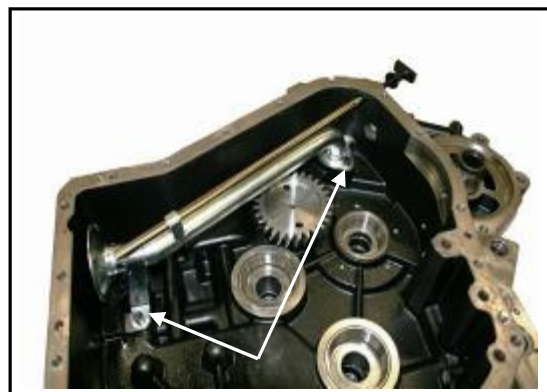

4:24 Remove the Dipstick from the tube. Remove the 3 cap screws from the suction tube supports (arrowed).

## Method Of Operation



4:25 Remove the Dipstick tube nut and seal and remove the suction tube assembly from inside the casing.



4:26 By hand or using a strap wrench remove and discard the oil filter.



4:27 Remove the 4 bearing cups from the front casing



4:28 Remove the 3 o rings from the oil transfer ports in the rear casing



4:29 Turn over the front casing and support on a suitable bench.



4:30 Remove the plastic plugs and 4 capscrews from the Forward High clutch valve assembly.

## Method Of Operation

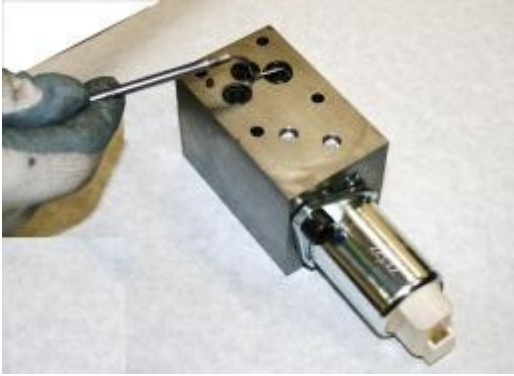

4:31 Remove the 3 O ring seals from the Forward / High Clutch valve.

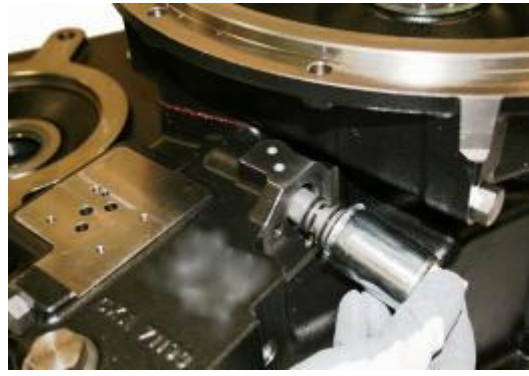

4:32 Remove the Cap screw and clamp plate and remove the 3rd Clutch solenoid valve cartridge.



4:33 Remove the 15 Bolts securing the Torque Converter housing to the front casing.



4:34 Using a suitable lever, prise the Torque converter housing away from the front casing.



4:35 Lift the housing from the front casing.



4:36 Using a suitable tool remove the seal from the Torque converter housing and discard.



## Method Of Operation



4:37 Use Two flat bladed screwdrivers and remove the Thrust washer from converter housing. If the converter wear ring is worn drive out discard and replace.



4:38 The Front casing with Torque Converter housing removed



4:39 Remove the 4 O ring seals from the oil transfer ports on the front casing.



4:40 Remove the Spacer from the Pump idler gear



4:41 Lift the Pump idler gear from the support shaft



4:42 Remove the support shaft & Bearing assembly

## Method Of Operation



4:43 Remove the O ring from the support shaft.



4:44 Lift out the Pump drive shaft assembly



4:45 Remove the top snap ring from the Pump drive shaft assembly



4:46 Remove the top Thrust Disc



4:47 Invert the Pump drive shaft and remove the bottom snap ring.



4:48 Remove the bottom Thrust Disc



## Method Of Operation



4:49 Using a suitable tool remove the bearing from the front casing.  
Note! The bearing cannot be re-used and must be replaced if removed.



4:50 Remove the Pump drive gear O ring



4:51 Remove the Pump drive gear.



4:52 Remove the Pump drive gear thrust washer.



4:53 Undo the 5 Cap screws retaining the Stator support hub.



4:54 Lift off the Stator support hub from the front casing.

## Method Of Operation



4:55 Raise and support the Front casing



4:56 Remove the Reverse idler gear. Insert two suitable pins into the holes in the gear and lock the gear into position.



4:57 With the gear locked onto the bolt on the shaft. Remove the Bolt and washer.



4:58 Remove the bearing from the front casing.



4:59 Remove the bearing spacer from the front casing.



4:60 Remove the Reverse Idler gear.

## Method Of Operation



4:61 Remove the bearing cup from the inside of the front casing  
Note! If Bearing cups are to be re-used ensure they are marked and returned to the same positions.



4:62 Remove the bearing cup from the outside of the front casing

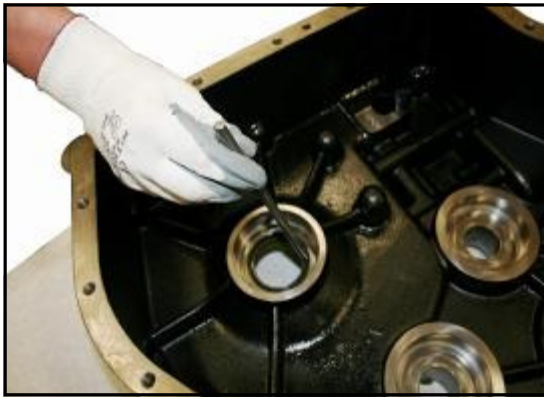

4:63 Using a suitable tool remove and discard the out put shaft seal.



4:64 Remove each of the bearing cups from the rear casing.



4:65 Remove the shim pack from behind each of the bearing cups in the rear casing



4:66 Remove and discard the shimming plug from each of the shafts in the rear casing.

**This page is left intentionally blank**



## Disassembly of the 1st / 2nd Clutch shaft



5:1 Support the 1st / 2nd clutch shaft and install the appropriate bearing puller to remove the gear and bearing from the 2nd clutch.



5:2 Remove the bearing from the shaft.



5:3 Remove the gear from the splined shaft.



5:4 Remove the spacer.



5:5 Remove the outer thrust washer and bearing.



5:6 Withdraw the hub gear from the 2nd clutch pack.

## Disassembly of the 1st / 2nd Clutch shaft



5:7 Remove the hub gear support bearings from the 2nd clutch pack.



5:8 Remove the inner thrust washer and bearing.



5:9 Using an appropriate tool remove the double snap ring from the 2nd clutch pack.



5:10 Remove the retainer plate.



5:11 Remove the clutch counter plates and friction plates.



5:12 Push down on the spring pack and using a suitable tool remove the circlip.

## Disassembly of the 1st / 2nd Clutch shaft



5:13 Remove the spring pack assembly from the 2nd clutch housing.



5:14 Using an air line with a low pressure supply pressurise the 2nd Clutch to remove the piston from the clutch housing.



5:15 Remove the piston from the clutch housing.



5:16 Remove and discard the 3 sealing rings from the end of the shaft.



5:17 Invert & support the 1st / 2nd clutch shaft and install the appropriate bearing puller to remove the gear and bearing from the 1st clutch.



5:18 Remove the bearing from the shaft.

## Disassembly of the 1st / 2nd Clutch shaft



5:19 Remove the outer thrust washer and bearing.



5:20 Withdraw the hub gear from the 1st clutch pack.



5:21 Remove the hub gear support bearings from the 1st clutch pack.



5:22 Remove the inner thrust washer and bearing.



5:23 Using an appropriate tool remove the double snap ring from the 1st clutch pack.



5:24 Remove the retainer plate.



## Disassembly of the 1st / 2nd Clutch shaft



5:25 Remove the clutch counter plates and friction plates.



5:26 Push down on the spring pack and using a suitable tool remove the circlip.



5:27 Remove the spring pack assembly from the 1st clutch housing.



5:28 Using an air line with a low pressure supply pressurise the 1st Clutch to remove the piston from the clutch housing.



5:29 Remove the piston from the clutch housing.

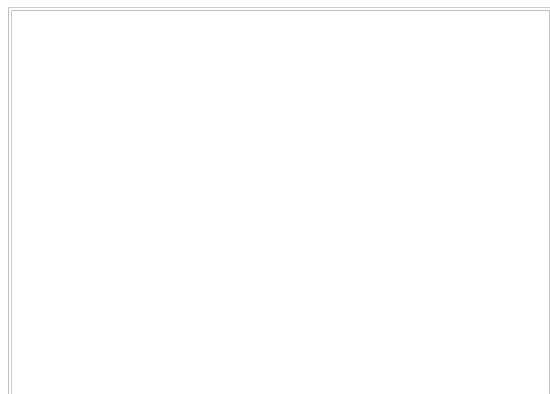

**This page is left intentionally blank**

## Reassembly of the 1st / 2nd Clutch shaft



6:1 Replace the piston into the 1st clutch housing.  
Lubricate the piston before reassembly



6:2 Replace the spring pack assembly into the 1st clutch housing.

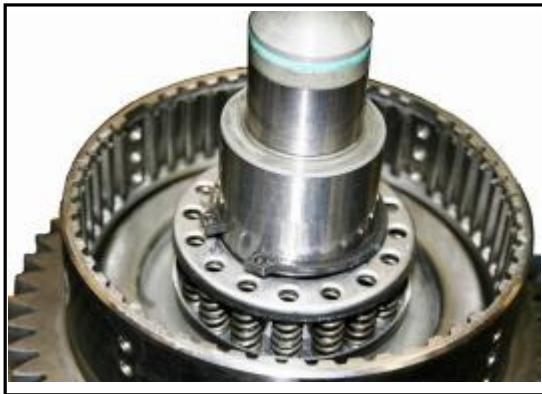

6:3 Loosely fit the circlip to the clutch shaft and push down onto spring pack.



6:4 Use a flat blade screwdriver or other suitable tool to push down on the Circlip until the spring pack is compressed sufficiently for the Circlip to snap into the groove.



6:5 Replace the Friction and Counter plates into the clutch housing. Ensure the counter plate is installed first adjacent to the piston.



6:6 Replace the retainer plate.

## Reassembly of the 1st / 2nd Clutch shaft



6:7 Replace the double snap ring into the 1st clutch pack.



6:8 Replace the inner thrust washer and bearing.

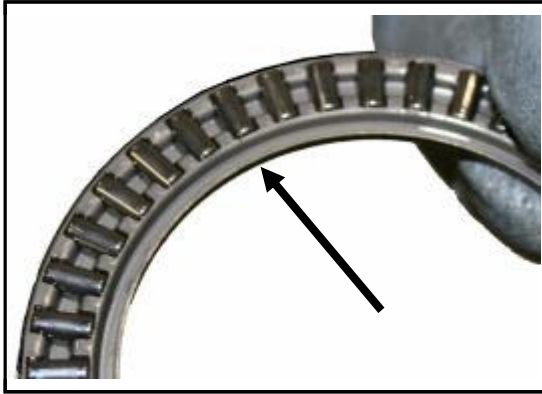

6:9 The internal diameter of the thrust bearing has a concave lip. Ensure this is placed adjacent to the thrust washer on assembly.



6:10 Replace the hub gear support bearings for the 1st clutch pack.



6:11 Replace the hub gear to the 1st clutch pack.



6:12 Replace the outer thrust washer and bearing.

## Reassembly of the 1st / 2nd Clutch shaft

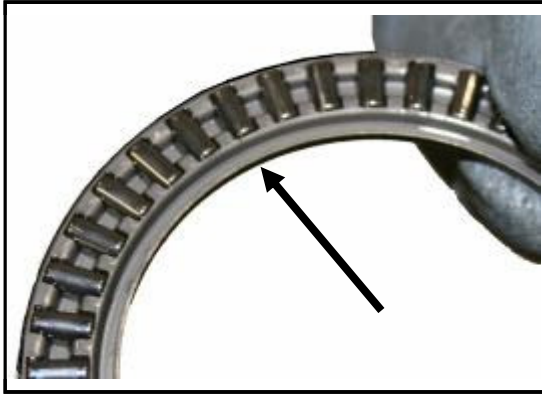

6:13 The internal diameter of the thrust bearing has a concave lip. Ensure this is placed adjacent to the thrust washer on assembly.



6:14 Replace the bearing.



6:15 Using a suitable tube carefully drive the bearing fully onto the shaft



6:16 Invert the shaft assembly and replace the piston to the 2nd clutch housing. Lubricate the piston before reassembly



6:17 Replace the spring pack assembly to the 2nd clutch housing.



6:18 Loosely fit the circlip to the clutch shaft and push down onto spring pack.



## Reassembly of the 1st / 2nd Clutch shaft



6:19 Use a flat blade screwdriver or other suitable tool to push down on the Circlip until the spring pack is compressed sufficiently for the Circlip to snap into the groove.



6:20 Replace the Friction and Counter plates into the clutch housing. Ensure the counter plate is installed first adjacent to the piston.



6:21 Replace the retainer plate.



6:22 Replace the double snap ring to the 2nd clutch pack.



6:23 Replace the inner thrust washer and bearing.

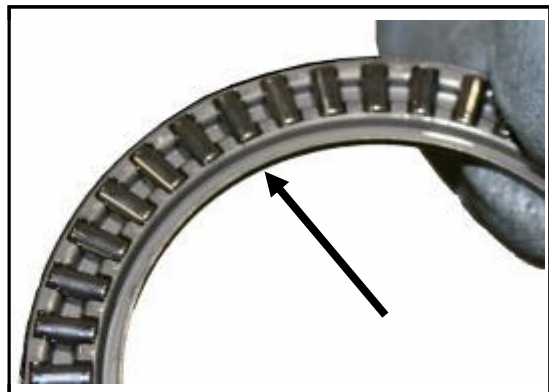

6:24 The internal diameter of the thrust bearing has a concave lip. Ensure this is placed adjacent to the thrust washer on assembly.

## Reassembly of the 1st / 2nd Clutch shaft



6:25 Replace the hub gear support bearings to the 2nd clutch pack.



6:26 Replace the hub gear to the 2nd clutch pack.



6:27 Replace the outer thrust washer and bearing.

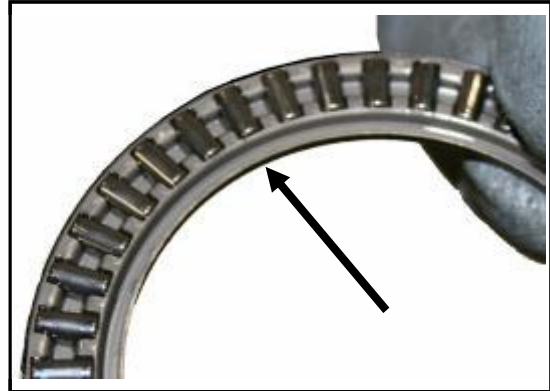

6:28 The internal diameter of the thrust bearing has a concave lip. Ensure this is placed adjacent to the thrust washer on assembly.



6:29 Replace the spacer.



6:30 Replace the gear to the splined shaft.

## Reassembly of the 1st / 2nd Clutch shaft



6:31 Reinstall the bearing to the shaft.



6:32 Using a suitable tube carefully drive the bearing fully onto the shaft



6:33 Carefully install the 4 seal rings to the shaft.



6:34 Using an air line with a low pressure supply pressurise the clutches to test operation..

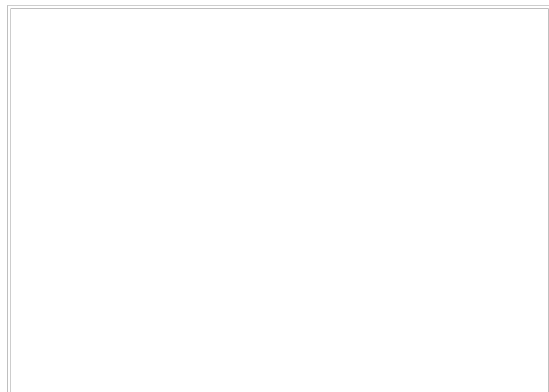
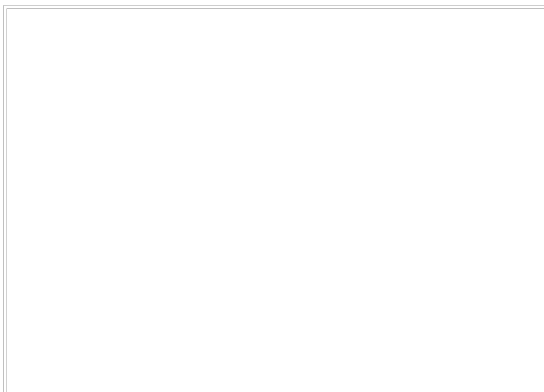



## Disassembly of the Output Shaft



7:1 Support the output shaft and install the appropriate bearing puller to remove the gear and bearing.



7:2 Remove the bearing from the shaft.



7:3 Remove the gear from the shaft.



The remaining bearing can be removed using a suitable puller.  
Reassembly is the reverse of the disassembly procedure.

**This page is left intentionally blank**

## Disassembly of the Forward High / 3rd Clutch shaft



8:1 Support the shaft and install the appropriate bearing puller before removing the gear and bearings.



8:2 The gear and bearings can be removed from the clutch shaft assembly



8:3 Remove the spacer from the shaft.



8:4 Use a suitable tool to carefully prise the snap ring from its retaining groove.



8:5 Remove the double snap ring from the 3rd Clutch



8:6 Lift out the Clutch pack retaining plate.

## Disassembly of the Forward High / 3rd Clutch shaft



8:7 Remove the counter and friction plates.  
Note! The counter plate is placed against the retainer.



8:8 Install the appropriate bearing puller to remove the 3rd clutch internal bearing.



8:9 Remove the bearing



8:10 Push down on the spring pack and remove the circlip.



8:11 Lift out the spring pack.



8:12 Using an air line with a low pressure supply pressurise the 3rd Clutch to remove the piston from the clutch housing.

## Disassembly of the Forward High / 3rd Clutch shaft



8:13 Remove the piston assembly



8:14 Remove and discard the 3 sealing rings from the end of the shaft.



8:15 Invert the shaft and install the appropriate bearing puller to remove the gear and bearing.



8:16 Remove the bearing from the forward High clutch



8:17 Remove the gear from the forward High clutch



8:18 Remove the spacer from the forward High clutch

## Disassembly of the Forward High / 3rd Clutch shaft



8:19 Remove the Two thrust bearings



8:20 Remove the gear from the Forward High clutch



8:21 Remove the Two support bearings



8:22 Remove the Two thrust bearings



8:23 Push down on the spring pack and remove the circlip.



8:24 Remove the spring pack assembly



## Disassembly of the Forward High / 3rd Clutch shaft



8:25 Remove the double snap ring from the Forward High clutch pack.



8:26 Lift out the Clutch pack retaining plate.



8:27 Remove the counter and friction plates.  
Note! The counter plate is placed against the retainer.



8:28 Using an air line with a low pressure supply pressurise the Forward High Clutch to remove the piston from the clutch housing.



8:29 Remove the piston from the clutch housing.

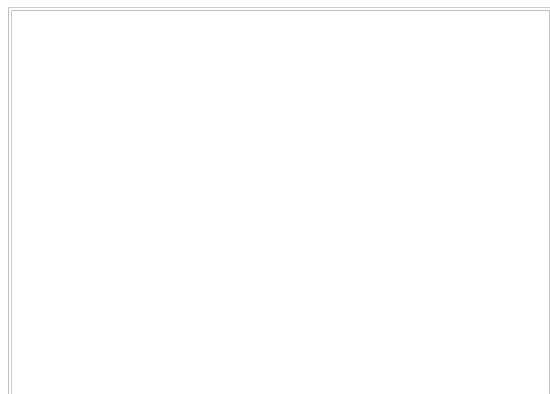

## Reassembly of the Forward High / 3rd Clutch shaft



9:1 Replace the piston into the Forward High clutch housing. Lubricate the piston before reassembly



9:2 Replace the counter and friction plates. Ensure the counter plate is placed against the piston.



9:3 Refit the Clutch pack retaining plate.



9:4 Replace the spring pack assembly



9:5 Loosely install the Circlip onto the shaft. The circlip has a flat face ensure this is placed facing upwards.

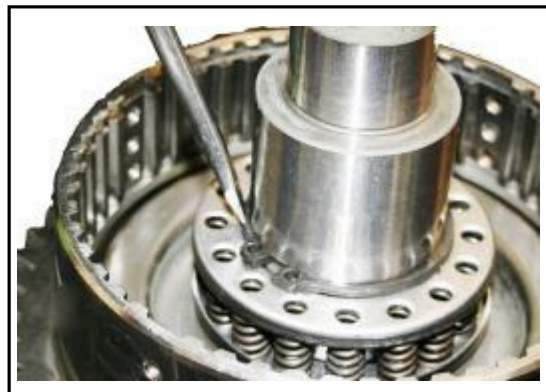

9:6 Use a flat blade screwdriver or other suitable tool to push down on the Circlip until the spring pack is compressed sufficiently for the Circlip to snap into the groove.

## Reassembly of the Forward High / 3rd Clutch shaft



9:7 Replace the inner thrust washer and bearing.

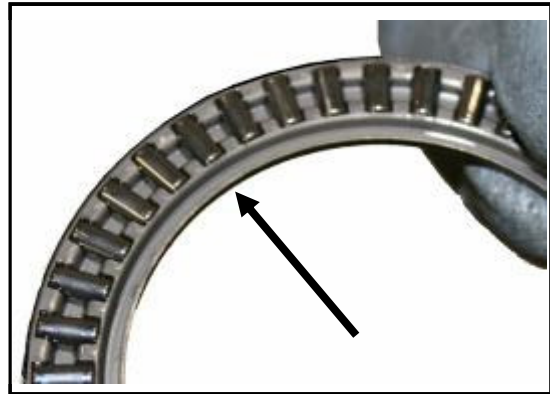

9:8 The internal diameter of the thrust bearing has a concave lip. Ensure this is placed adjacent to the thrust washer on assembly.



9:9 Replace the double snap ring to the Forward High clutch pack.



9:10 Replace the Two hub gear support bearings

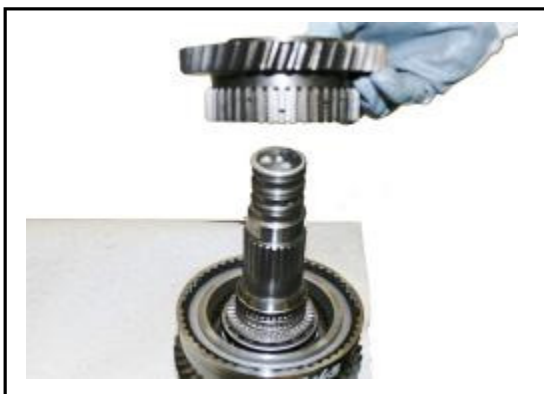

9:11 Replace the hub gear to the Forward High clutch housing.



9:12 Replace the outer thrust washer and bearing.

## Reassembly of the Forward High / 3rd Clutch shaft

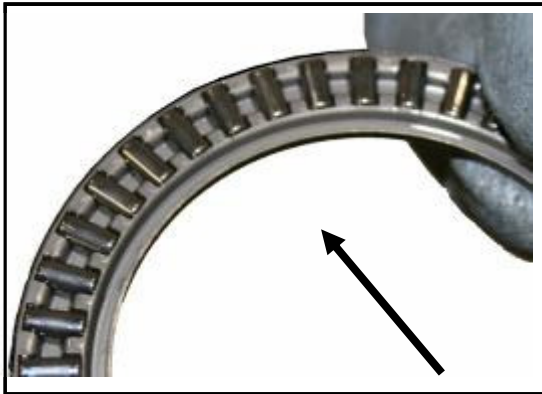

9:13 The internal diameter of the thrust bearing has a concave lip. Ensure this is placed adjacent to the thrust washer on assembly.



9:14 Replace the spacer to the Forward High clutch shaft.



9:15 Replace the gear to the splined shaft



9:16 Replace the bearing to the Forward High clutch shaft



9:17 Using a suitable tube carefully drive the bearing fully onto the shaft



9:18 Invert the shaft and install the piston to the 3rd Clutch Housing  
Lubricate the piston before reassembly



## Reassembly of the Forward High / 3rd Clutch shaft



9:19 Install the spring pack.



9:20 Loosely install the circlip onto the shaft and push down onto the spring pack. The circlip has a flat face ensure this is placed facing upwards.

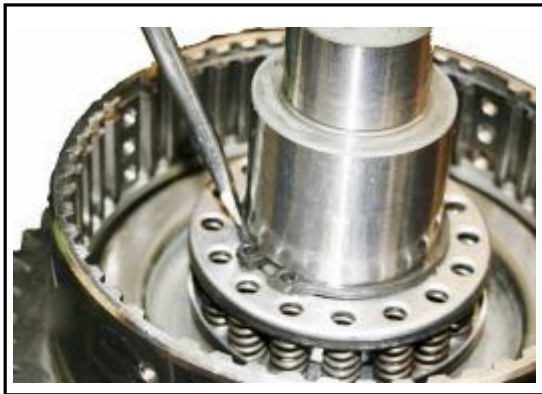

9:21 Use a flat blade screwdriver or other suitable tool to push down on the Circlip until the spring pack is compressed sufficiently for the Circlip to snap into the groove.



9:22 Using a suitable tube replace the bearing onto the shaft.



9:23 Replace the Friction and Counter plates into the clutch housing. Ensure the counter plate is installed first adjacent to the piston.



9:24 Replace the Clutch pack retaining plate.

## Reassembly of the Forward High / 3rd Clutch shaft



9:25 Replace the double snap ring from the 3rd Clutch



9:26 Replace the spacer to the shaft.



9:27 Fit the hub gear to the 3rd clutch housing.



9:28 Replace the bearing to the 3rd clutch gear



9:29 Use a suitable tube or press drive the upper bearing onto the shaft.



9:30 Carefully install the 3 sealing rings to the end of the shaft.



## Reassembly of the Forward High / 3rd Clutch shaft

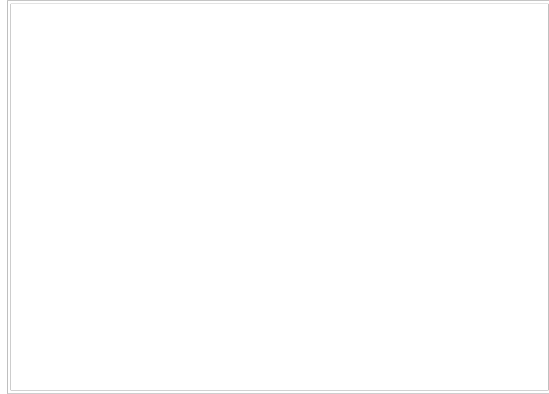

9:31 Using an air line with a low pressure supply to pressurise the clutches, test the operation

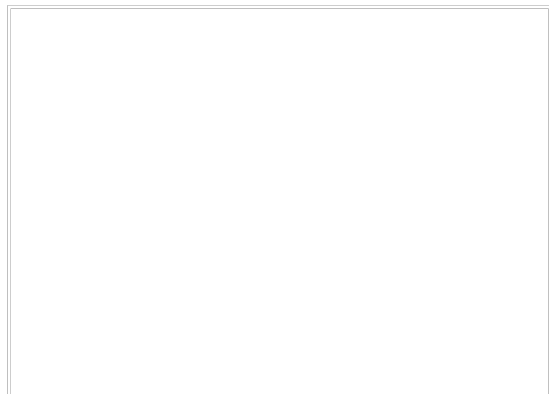
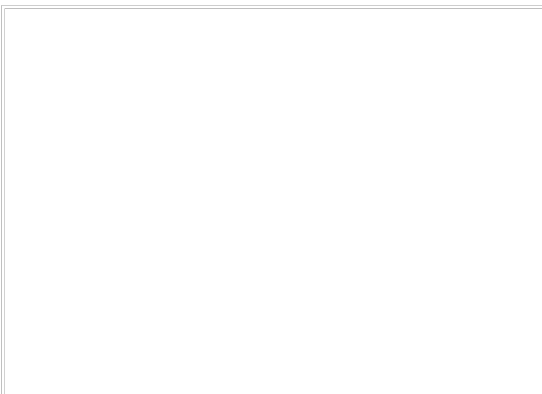
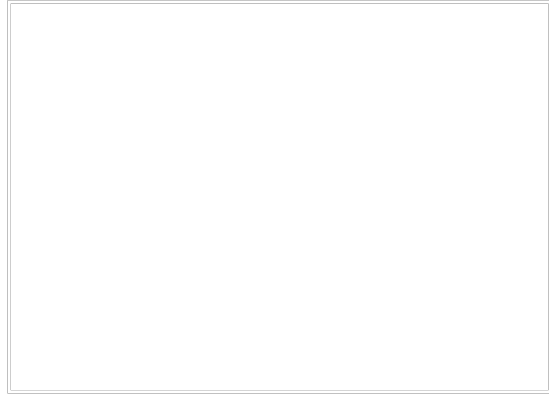
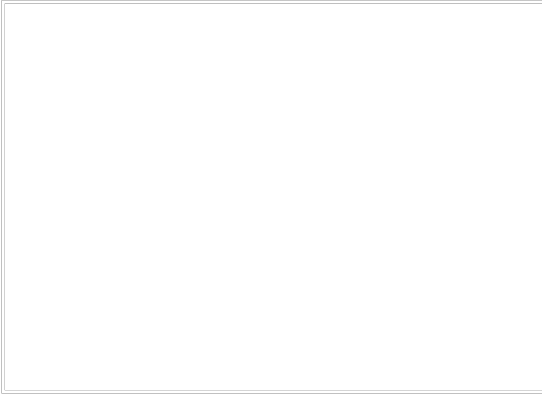

## Disassembly of the Forward Low / Reverse Shaft



10:1 Support the shaft and install the appropriate bearing puller and prepare to remove the gear and bearing.



10:2 Remove the bearing from the Forward Low clutch shaft.



10:3 Remove the outer thrust washer and bearing



10:4 Remove the Forward Low clutch Hub gear



10:5 Remove and discard the 3 sealing rings from the shaft



10:6 Remove the 2 hub gear support bearings

## Disassembly of the Forward Low / Reverse Shaft



10:7 Remove the inner thrust washer and bearing



10:8 Use a suitable tool to carefully prise the snap ring from its retaining groove.



10:9 Remove the double snap ring from the Forward Low clutch.



10:10 Lift out the Clutch pack retaining plate.



10:11 Remove the counter and friction plates.  
Note! The counter plate is placed against the retainer.



10:12 Push down on the spring pack and remove the circlip.

## Disassembly of the Forward Low / Reverse Shaft



10:13 Remove the circlip



10:14 Lift out the spring pack.



10:15 Using an air line with a low pressure supply pressurise the Forward Low Clutch to remove the piston from the clutch housing.



10:16 Remove the Piston from the cylinder



10:17 Remove the Piston Spacer from the cylinder

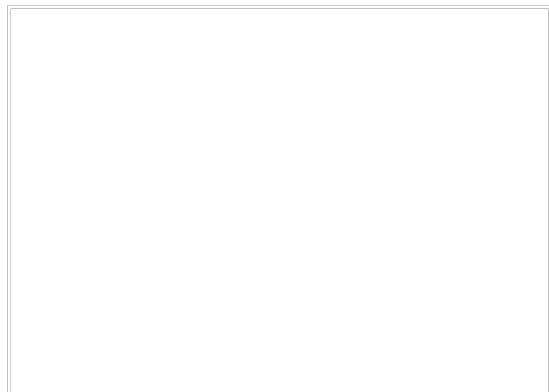

## Disassembly of the Forward Low / Reverse Shaft



10:18 Invert and support the shaft and using appropriate levers as shown prepare to remove the gear and bearing.



10:19 Remove the bearing.



10:20 Remove the outer thrust washer and bearing.



10:21 Remove the Reverse clutch hub gear.



10:22 Remove the inner thrust washer and bearing.



10:23 Use a suitable tool to carefully prise the snap ring from its retaining groove.

## Disassembly of the Forward Low / Reverse Shaft



10:24 Remove the double snap ring from the Reverse clutch.



10:25 Remove and discard the seal from the shaft.



10:26 Remove the retainer.



10:27 Remove the counter and friction plates.  
Note! The counter plate is placed against the retainer.



10:28 Push down on the spring pack and remove the circlip.



10:29 Remove the circlip



## Disassembly of the Forward Low / Reverse Shaft



10:30 Lift out the spring pack assembly.



10:31 Using an air line with a low pressure supply pressurise the Reverse Clutch to remove the piston from the clutch housing.



10:32 Remove the Piston from the cylinder

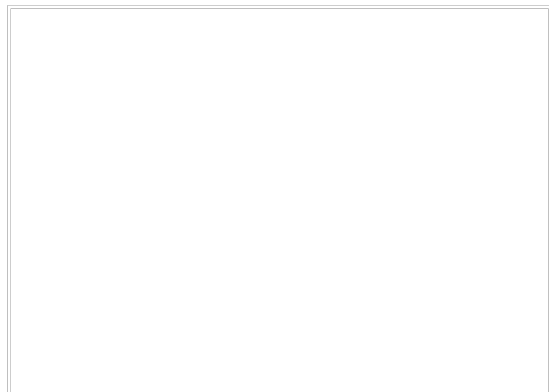
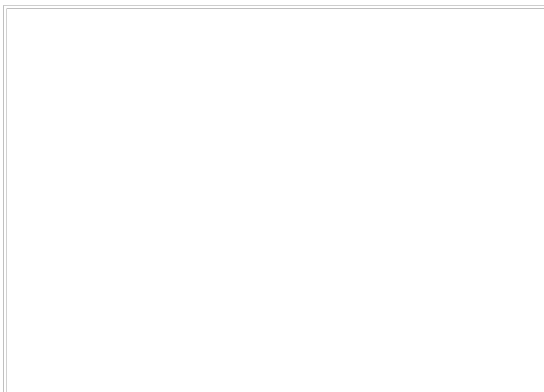
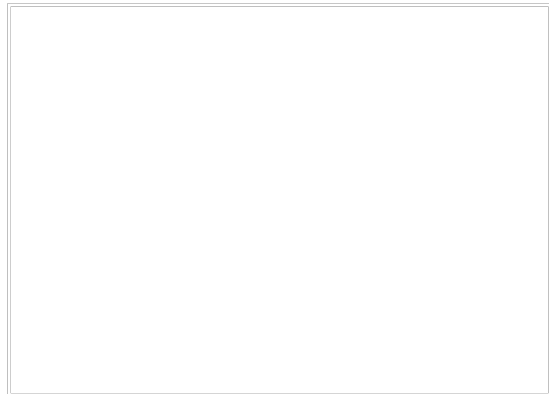

## Reassembly of the Forward Low / Reverse Shaft



11:1 Replace the Piston to the Reverse clutch cylinder.  
Lubricate the piston before reassembly



11:2 Replace the spring pack assembly.



11:3 Loosely fit the circlip to the shaft and push down onto the spring pack.

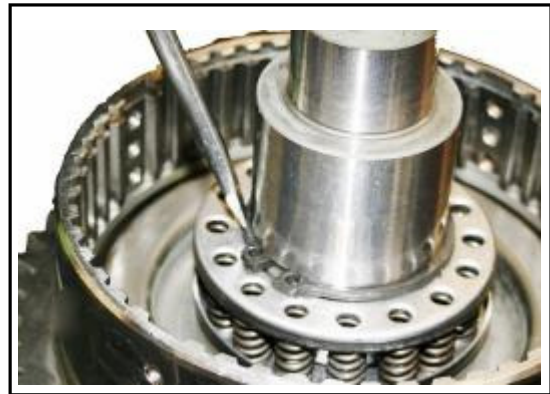

11:4 Use a flat blade screwdriver or other suitable tool to push down on the Circlip until the spring pack is compressed sufficiently for the Circlip to snap into the groove.



11:5 Refit the counter and friction plates to the clutch assembly.  
Note! The counter plate is placed adjacent to the piston



11:6 Replace the retainer.

## Reassembly of the Forward Low / Reverse Shaft



11:7 Replace the double snap ring to the Reverse clutch housing.



11:8 Replace the inner thrust washer and bearing.

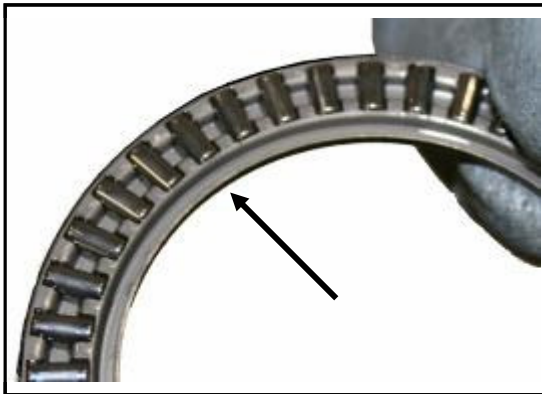

11:9 The internal diameter of the thrust bearing has a concave lip. Ensure this is placed adjacent to the thrust washer on assembly.



11:10 Replace the Reverse clutch hub gear.



11:11 Replace the outer thrust washer and bearing.

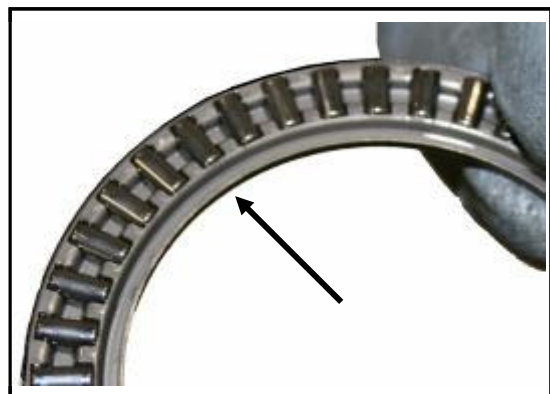

11:12 The internal diameter of the thrust bearing has a concave lip. Ensure this is placed adjacent to the thrust washer on assembly.

## Reassembly of the Forward Low / Reverse Shaft



11:13 Use a suitable tube and install the bearing to the shaft.



11:14 Invert the shaft and replace the Piston spacer to the Forward Low clutch cylinder  
Lubricate the piston before reassembly



11:15 Fit the Piston to the Forward Low clutch cylinder  
Lubricate the piston before reassembly



11:16 Replace the spring pack. assembly



11:17 Loosely install the circlip onto the shaft and push down onto the spring pack.

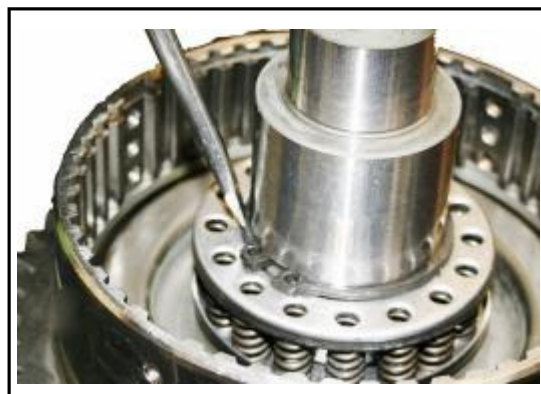

11:18 Use a flat blade screwdriver or other suitable tool to push down on the Circlip until the spring pack is compressed sufficiently for the Circlip to snap into the groove.

## Reassembly of the Forward Low / Reverse Shaft



11:19 Replace the counter and friction plates.  
Note! The counter plate is placed against the piston.



11:20 Refit the Clutch pack retaining plate.



11:21 Replace the double snap ring to the Forward Low clutch.



11:22 Replace the inner thrust washer and bearing

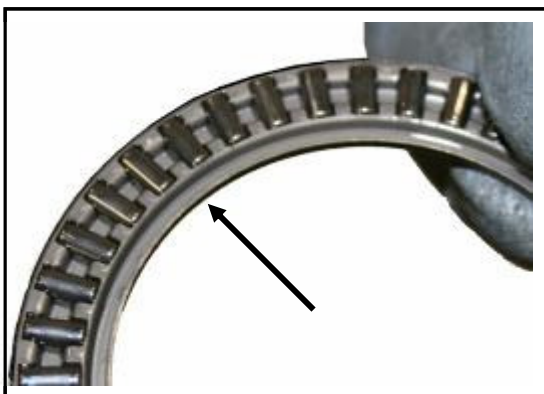

11:23 The internal diameter of the thrust bearing has a concave lip. Ensure this is placed adjacent to the thrust washer on assembly.

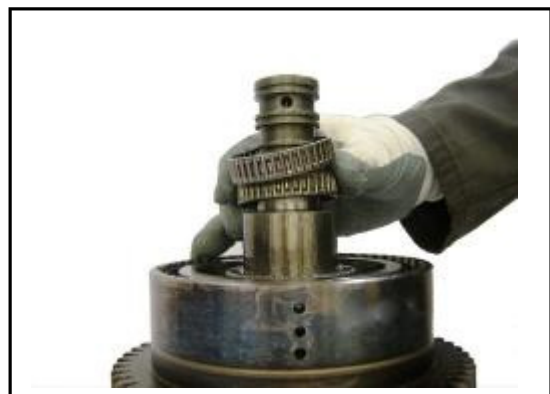

11:24 Install the 2 hub gear support bearings



## Reassembly of the Forward Low / Reverse Shaft



11:25 Replace the Forward Low clutch Hub gear



11:26 Replace the outer thrust washer and bearing

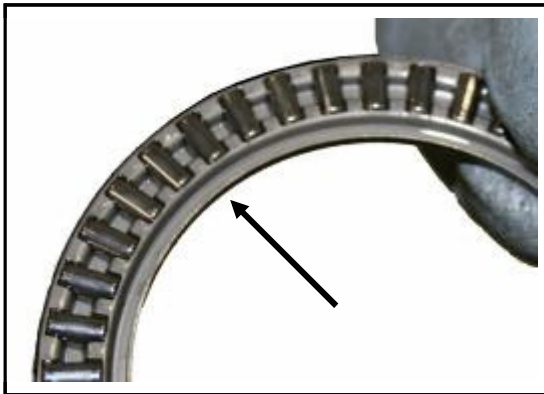

11:27 The internal diameter of the thrust bearing has a concave lip. Ensure this is placed adjacent to the thrust washer on assembly.



11:28 Using a suitable tool refit the bearing to the Forward Low clutch shaft.



11:29 Replace the 3 sealing rings to the shaft



11:30 Using an air line with a low pressure supply pressurise the clutches to test operation.



## Disassembly of the Pump



12:1 Remove the single screw from the pump back plate



12:2 Remove the pump back plate



12:3 Remove the pump hub gear



12:4 Remove the pump annulus gear



The annulus gear is chamfered on the lower side (arrowed) . Ensure the gear is fitted correctly when re- assembling



Reassembly is the reverse of the above procedure.

## Disassembly of the Control Valves

### CAUTION



Disassembly of the control valves is not generally recommended as, with the exception of the solenoids, individual parts are non serviceable.

These parts may however, be dismantled for cleaning and examination.

## Disassembly of the Control Valves



13:1 The Dual Modulating Valve assembled. There are 4 O rings on the underside that may be renewed as necessary.



13:2 The Dual Modulating Valve with the retaining nut, solenoid and O ring seals removed.



13:3 The Dual Modulating Valve with the modulation components removed.



13:4 The Dual Modulating Valve with the modulation components removed.



13:5 The Dual Modulating Valve with the Solenoid spool and O ring seals removed.



### **General Reassembly Notes**

All nylon patch bolts may be reused 5 to 6 times provided a prevailing thread torque of 1.7 - 2.0 Nm (15 - 18 lb.in.) is recorded.

All shafts and bearings should be lubricated with clean transmission fluid prior to assembly.

**CAUTION**



To prevent possible contamination of hydraulic parts , avoid the use of lint or cotton rags when handling components.

## Reassembly of the Transmission



14:1 Prepare the transmission for reassembly, remove all traces of sealant from the mating faces. Replace the bearing for the pump drive shaft.



14:2 Reinstall the bearing cups to the rear of the front casing.



14:3 From the rear of the front casing install the reverse idler gear and bearing assembly.



14:4 Reinstall the bearing cups and shims to the front of the front casing.



14:5 Install the bearing to the reverse idler gear assembly from the front of the casing.



14:6 Install the bearing spacer.



## Reassembly of the Transmission



14:7 Install the Thrust plate and retaining bolt.



14:8 Insert Two suitable pins to lock the gear into position.



14:9 Tighten the retaining bolt to the required torque.  
66-88 Nm (50—65 lb ft)



14:10 Clean the mating surfaces and replace the Stator support hub to the front casing.



14:11 Tighten the retaining capscrews to the required torque.  
18 - 31 Nm (13 -23 lb ft)



14:12 Fit a Dial test indicator and check the preload / endfloat of the reverse idler gear.  
-0.0508 to +0.0254mm (-0.002" to +0.001")  
Repeat steps 14:4 to 14:9 Inserting shims as required until correct.



## Reassembly of the Transmission



14:13 Replace the Pump drive gear thrust washer.



14:14 Replace the Pump drive gear.



14:15 Re-install the pump drive gear O ring.



14:16 Replace the lower thrust disc to the pump drive shaft assembly



14:17 Fit the lower thrust disc snap ring.



14:18 Replace the upper thrust disc.

## Reassembly of the Transmission



14:19 Fit the upper snap ring to the Pump drive shaft assembly



14:20 Refit the Pump drive shaft assembly



14:21 Replace the O ring to the support shaft assembly



14:22 Replace the support shaft & bearing assembly into the front casing.



14:23 Refit the Pump idler gear to the support shaft. Check that the bearing retaining circlip is on the underside.



14:24 Refit the Spacer to the Pump idler gear

## Reassembly of the Transmission



14:25 Reinstall the three large and one small O rings to the mating face of the front casing.



14:26 Refit the Oil seal



14:27 Apply sealant to the mating face of the front casing.



14:28 Refit the Torque Converter housing.



14:29 Tighten the bolts to the required torque.  
45—64 Nm ( 33 - 47 lb ft)



14:30 Invert the casing and refit the Pump assembly.



## Reassembly of the Transmission



14:31 Progressively tighten the retaining bolts to the required torque. Keep checking that gears rotate freely during the tightening procedure. Refer to page 27 for sequence.

18 - 21 Nm ( 13 - 23 lb ft)



14:32 Replace the pump O Ring seal.

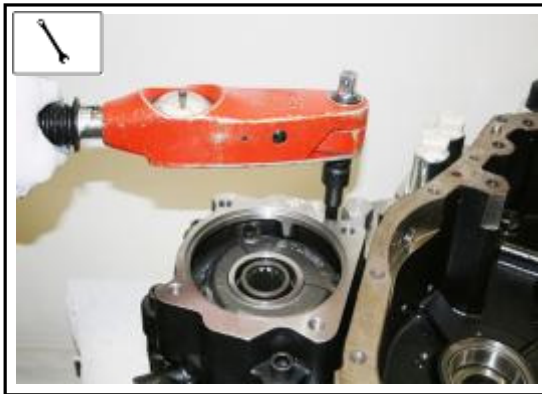

14:33 Refit the Pump housing , tighten the retaining bolts to the required torque.

63 - 88 Nm ( 50 - 65 lb ft)



14:34 Prepare the rear casing for reassembly by replacing the bearing cups. DO NOT fit shims at this stage.



14:35 Refit the transfer tube, tighten the three capscrews to the required torque.

18 - 31 Nm ( 13 - 23 lb ft)



14:36 Refit the dipstick tube and tighten the nut and seal.

## Reassembly of the Transmission



14:37 By hand or using suitable lifting equipment install the 1st/2nd clutch shaft into the front casing. Take care to avoid damaging the shaft seals when assembling.



14:38 By hand or using suitable lifting equipment install the Forward Low / Reverse clutch shaft into the front casing.

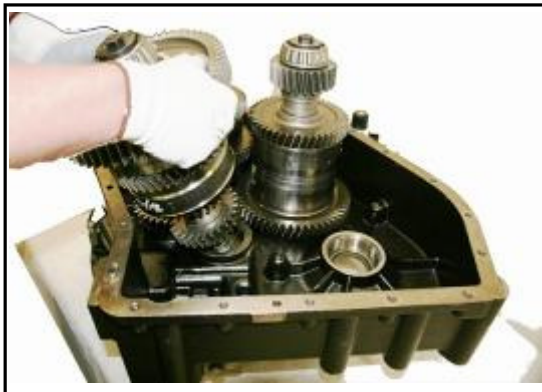

14:39 By hand or using suitable lifting equipment install the Forward High / 3rd clutch shaft into the front casing. Take care to avoid damaging the shaft seals when assembling.



14:40 Install the output shaft. Ensure that all gears are engaged correctly and are free to rotate.



14:41 Remove the Screw and Washer from the end of the 1st / 2nd clutch shaft



14:42 Remove the Screw and Washer from the end of the Forward High / Third clutch shaft.

## Reassembly of the Transmission



14:43 Using suitable lifting equipment refit the rear casing.



14:44 Progressively tighten the rear casing bolts to the required torque.

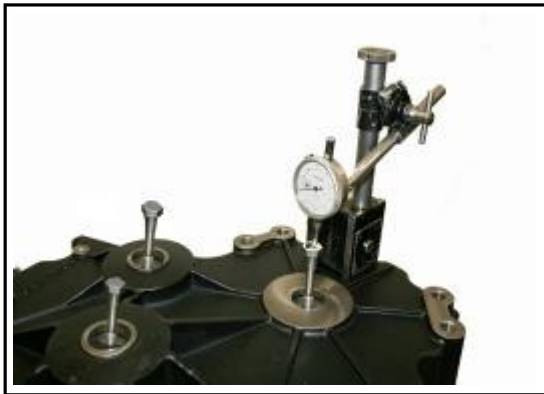

14:45 Install a suitable Bolt to each of the threaded holes in the end of the gear shafts. Install a Dial test indicator to measure the endfloat in each shaft. Set the indicator to zero.



14:46 Using a suitable bar and pivot block apply pressure to the bolt and record the amount of movement (endfloat) for each shaft.



14:47 Remove the rear case and install the correct shim pack behind bearing cup.

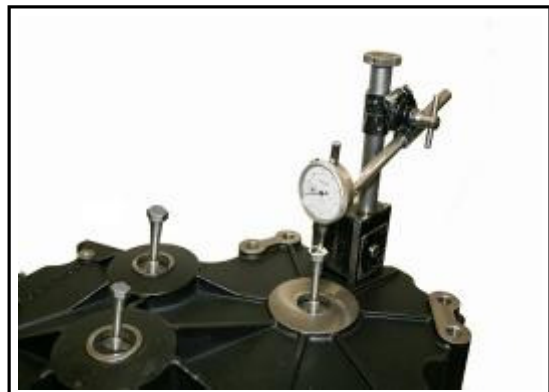

14:48 Recheck the endfloat. Repeat step 14:47 until the correct endfloat is achieved. +0.0254 to +0.0762mm (+0.001" to +0.003")



## Reassembly of the Transmission

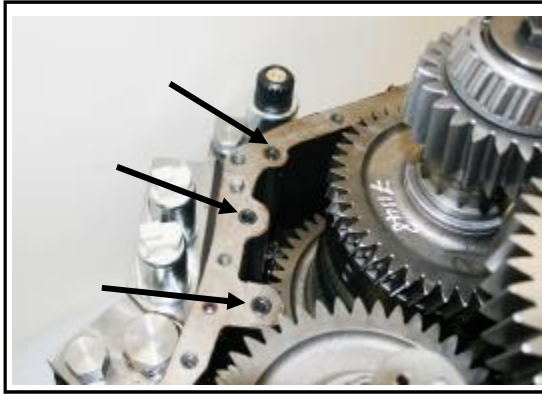

14:49 Fit the 3 O ring seals to the mating flange of the front case. Refit the bolts and washers to the end of each shaft.



14:50 Apply sealant to the mating flange

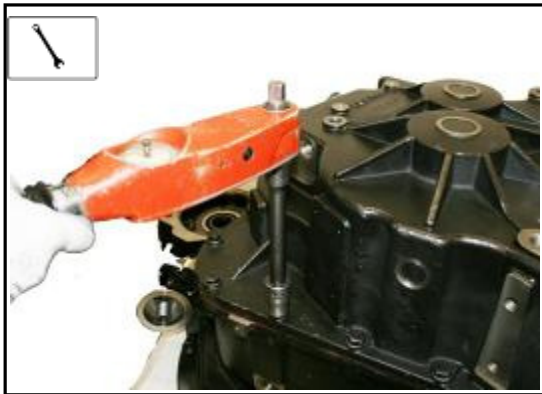

14:51 Refit the rear casing, progressively tighten the rear casing bolts to the required torque.

45 - 64 Nm ( 33 - 47 lb ft)



14:52 Locate the blanking plugs to each of the shimming access holes.



14:53 Using a suitable tool install the blanking plugs.



14:54 Replace the Dual Modulating Valve, and progressively tighten the cap screws to the required torque. Refer to page 27 for sequence.

7 - 10 Nm ( 5 - 7.5lb ft)

## Reassembly of the Transmission



14:55 Replace the Speed sensor and tighten the Clamp Bolt to the required torque

18 - 31 Nm ( 13 - 23 lb ft)



14:56 Replace the clutch solenoid valves, tighten the clamp screws to the required torque.

18 - 31 Nm ( 13 - 23 lb ft)



14:57 Remove the 3rd Clutch solenoid valve tighten the cap screw to the required torque

18 - 31 Nm ( 13 - 23 lb ft)

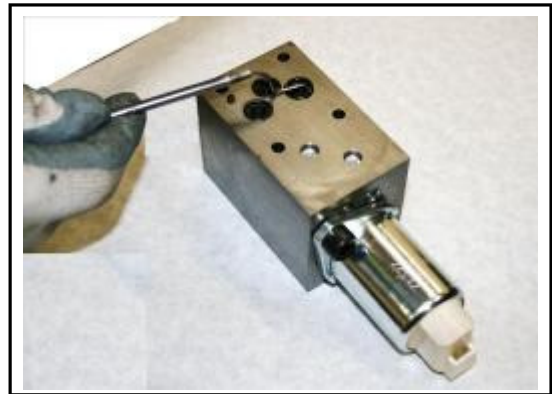

14:58 Replace the 3 O ring seals to the Forward / High Clutch valve.

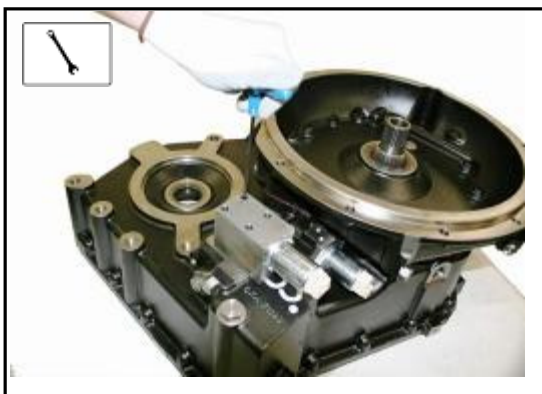

14:59 Replace the Forward High clutch valve Tighten the capscrews to the required torque

7 - 10 Nm ( 5 - 7.5 lb ft)



14:60 Replace the Main Pressure regulator valve cartridge and tighten to the required torque

45 - 64 Nm ( 33 - 47 lb ft)

## Reassembly of the Transmission



14:61 Replace the Relief valve cartridge and tighten to the required torque

23 - 30 Nm ( 17 - 22 lb ft)

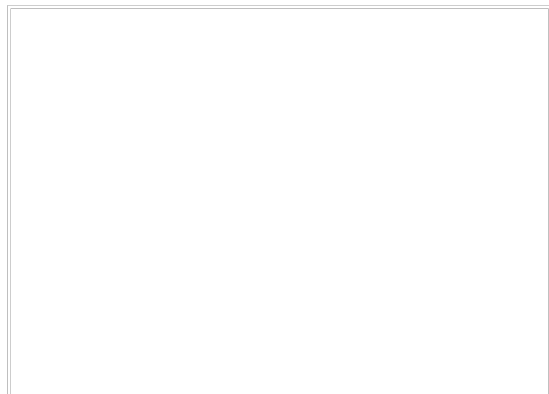
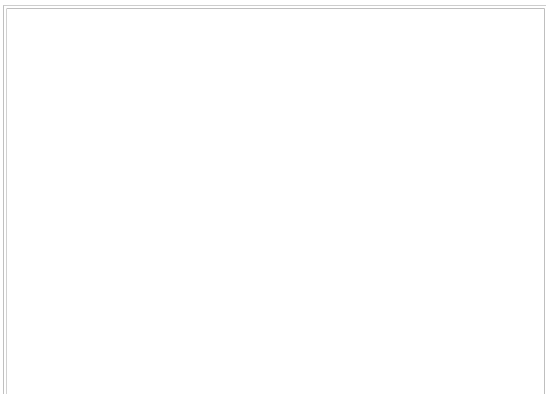
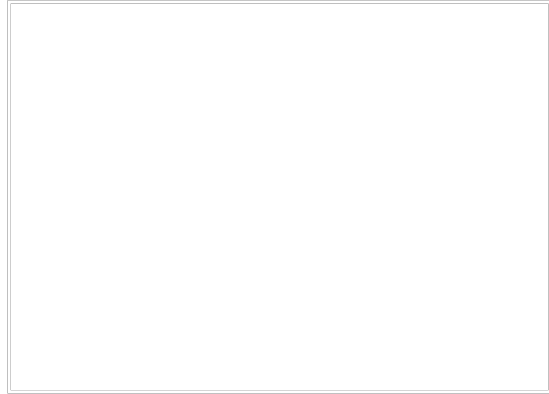
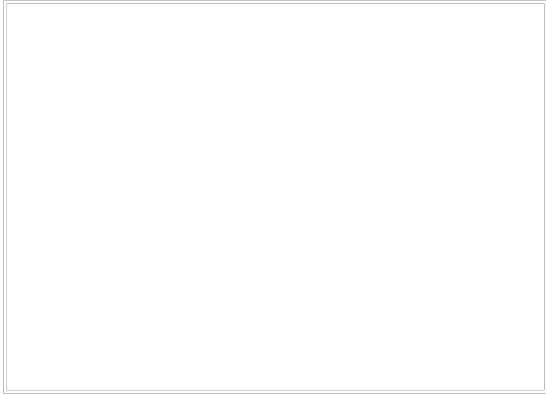
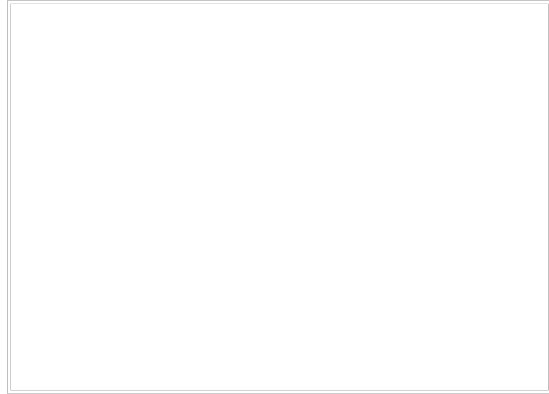



## Troubleshooting Guide

### Test Procedure

If a malfunction of the transmission is indicated a systematic pressure checking procedure should be followed. These checks should be carried out while the transmission is still in the vehicle so that true operating conditions are created. Pressure checks are essential since a failure in the hydraulic system may not be easily traceable when the transmission is stripped down on a bench.

All pressure checks should be carried out with the transmission oil temperature at 80 to 85 deg. C. and the engine speed maintained at 2000 to 2500 RPM.

As a safety precaution the vehicles parking brake should be applied (if fitted).

All pressure test ports have a 9/16" thread.

A pressure gauge is required that will measure up to 20 bar (290 lbf/in<sup>2</sup>).

For test port locations refer to illustrations on pages 12 and 13

The chart over page briefly summarises the pressures that should be found at each port, as well as showing which clutches are engaged in each gear.

# Troubleshooting Guide

Gear		Clutch Pressures										
		Forward Low Test Point T5	Forward High Test Point T4	Reverse Test Point T6	Clutch One Test Point T1	Clutch Two Test Point T2	Clutch Three Test Point T3	Forward Low Test Point T5	Forward High Test Point T4	Reverse Test Point T6	Clutch One Test Point T1	Clutch Two Test Point T2
Forward	1st	12 to 15.5	174 to 225	0	0	0	12 to 15	174 to 218	0	0	0	0
	2nd	12 to 15.5	174 to 225	0	0	0	0	12 to 15	174 to 218	0	0	0
	3rd	12 to 15.5	174 to 225	0	0	0	0	0	0	0	12 to 15	174 to 218
	4th	0	12 to 15.5	174 to 225	0	0	0	0	0	0	0	12 to 15
Reverse												
Converter	1st	0	0	0	0	12 to 15	174 to 218	12 to 15	174 to 218	0	0	0
	2nd	0	0	0	0	12 to 15	174 to 218	12 to 15	174 to 218	12 to 15	174 to 218	0
	3rd	0	0	0	0	12 to 15	174 to 218	12 to 15	174 to 218	0	0	12 to 15
Converter		High Idle Test Point T10	Low Idle									
Lubrication		7 to 10	101 to 145									
		High Idle	Low Idle									
		2 to 3.5	29 to 51	0.5 to 1.5	7 to 22							
Main		High Idle Test Point T9	Low Idle Test Point T9									
		15.5 to 17.5	224 to 253	14 to 16	203 to 232							



## Troubleshooting Guide

Ref	Reported Fault	Possible Cause	Investigation / Test	Rectification
<b>A.0</b>	Transmission fails to drive in either direction	A.1 Low oil level	Check oil level with engine idling and transmission oil cold	Add oil
		A.2 Low pump pressure	Check at test port T9	If low then see K.0
		A.3 Faulty pressure regulator	Check at different engine speeds	Replace if faulty
		A.4 Control valve defective	Energise independently	Change coils or valve
		A.5 Restricted flow of oil	Check for blockage	Remove blockage
<b>B.0</b>		A.6 Defective sealing rings	Inspect for damage	Replace
	Transmission drives only in certain gears	B.1 Low oil pressure in one clutch pack	Check at test port (T1 to T6) Refer to solenoid and clutch selection chart Pages 21 and 108	If low then see M.0
		B.2 Faulty control valve or coil	Energise independently Refer to solenoid and clutch selection chart Pages 21 and 108	Change coils or valve
		B.3 Restricted flow of oil	Check for blockage	Remove blockage
		B.4 Defective piston seals	Inspect for damage or wear	Replace
		B.5 Defective clutch pack	Check for amount of wear Refer to solenoid and clutch selection chart Pages 21 and 108	Replace if fully worn

## Troubleshooting Guide

Ref	Reported Fault	Possible Cause	Investigation / Test	Rectification
<b>B.0 Contd</b>		B.6 Defective shaft seals	Inspect for damage or wear	Replace
<b>C.0</b>	Delay in taking up drive	C.1 Low oil level	Check oil level with engine idling and transmission oil cold	Add oil
		C.2 Low clutch pack pressure	Check at test port	See M.0
		C.3 Faulty modulation of clutch pack pressure	Check pressure rise at test port	Change valve
		C.4 Blockage in valve	Compare both directions	Change valve
		C.5 Defective valve orifice	Check orifice	Change valve
		C.6 Restricted oil flow	Check case for blockages	Remove blockages
		C.7 Low Torque converter pressure	Check at test port	See section O.0
<b>D.0</b>	No drive from 4WD	D.1 Mechanical failure of transmission	Remove prop shaft and run transmission	Repair transmission
<b>E.0</b>	Overheating	E.1 Excessive operation with torque converter stalled	Discuss with operator	Reduce vehicle load/duty
		E.2 Cooler radiator blocked	Perform visual check	Clean out radiator

## Troubleshooting Guide

Ref	Reported Fault	Possible Cause	Investigation / Test	Rectification
<b>E.0 contd</b>		E.3 Oil cooler flow restricted by blockage	Check pressure at test port T7	Remove blockage
		E.4 Incorrect oil level	Check oil level with engine idling and transmission oil cold	Fill to correct level
		E.5 Clutch packs slipping	Check pressure at test port T1 to T6	See M.I.0
			Check wear	Renew clutch plates
		E.6 Mechanical failure		Repair transmission
	<b>F.0</b>	Vehicle creeps when neutral is selected	F.1 Clutch pack that is not selected has pressure applied	Check control valve
			Shaft seals are leaking	Replace seals
		F.2 Clutch pack not releasing when oil pressure removed	Mechanical failure	Repair clutch pack
		F.3 Mechanical failure		Repair transmission
<b>G.0</b>	Difficult gear selection	G.1 Clutch pack that is not selected has pressure applied	Check control valve	Change valve
			Shaft seals are leaking	Replace seals

## Troubleshooting Guide

Ref	Reported Fault	Possible Cause	Investigation / Test	Rectification
<b>G.0 Contd</b>		G.2 Clutch pack not releasing when oil pressure removed	Mechanical failure	Repair clutch pack
		G.3 Mechanical failure		Repair transmission
<b>H.0</b>	High stall speed	H.1 Low oil level	Check oil level with engine idling and transmission oil cold	Fill to correct level
		H.2 Air in oil	Check oil visually	Rectify cause
		H.3 Torque converter relief valve defective	Check pressures at test port T10	Replace valve
		H.4 Clutch packs slipping	Low pressure to clutch pack or worn clutch plates	See E.5
		H.5 Incorrect torque converter model	Visual check against specification	Replace
		H.6 Torque converter defective	Visual inspection	Replace
<b>I.0</b>	Low stall speed	I.1 Engine performance low	Refer to vehicle engine checks	Rectify and recheck stall speed
		I.2 Incorrect torque converter model	Visual check against specification	Replace
		I.3 Torque converter defective	Visual inspection	Replace

## Troubleshooting Guide

Ref	Reported Fault	Possible Cause	Investigation / Test	Rectification
<b>J.0</b>	High pump pressure	J.1 Defective pressure regulator valve	Check at different engine speeds	Replace
		J.2 Oil too thick	Visual check	Warm up oil and retest, else drain and replace
<b>K.0</b>	Low pump pressure	K.1 Transmission pump defective	Visually check if worn or broken	Replace
		K.2 Oil flow restricted	Check for blocked filter or suction strainer	Clean and/or replace
		K.3 Pump seal defective	Check for leaks	Replace
		K.4 Defective pressure regulator valve	Check if stuck open	Replace
		K.5 Defective cold start valve	Check if stuck open	Replace
		K.6 Loose hydraulic connections	Visual check	Tighten up connections
		K.7 Blocked suction port	Check for blockage in case	Remove blockage or replace case
<b>L.0</b>	High clutch pressure	L.1 Regulator valve defective	Check at different engine speeds	Replace if faulty
<b>M.0</b>	Low clutch pressure	M.1 Faulty control valve or coil	Energise independently	Change coils or valve



## Troubleshooting Guide

Ref	Reported Fault	Possible Cause	Investigation / Test	Rectification
<b>M.0 Contd</b>		M.2 Defective shaft seals	Visual check	Replace
		M.3 Defective piston seals	Visual check	Replace
<b>N.0</b>	High torque converter pressure	N.1 Torque converter relief valve defective	Visual check	Replace
		N.2 Blockage in oil cooler circuit	Visual check	Remove blockage
<b>O.0</b>	Low Torque converter pressure	O.1 Torque converter relief valve defective	Visual check	Replace
		O.2 Leaks in converter	Visual check	Replace
		O.3 Leaks in oil cooler circuit	Visual check	Rectify
<b>P.0</b>	Low lubrication pressure	P.1 Cooler circuit restriction	Visual check	Remove restriction
		P.2 Shaft seal leak	Visual check	Replace
<b>Q.0</b>	Noise	Q.1 Vehicle drive line	Check transmission alignment	Refer to specialist
			Check engine mountings	Refer to specialist

## Troubleshooting Guide

Ref	Reported Fault	Possible Cause	Investigation / Test	Rectification
<b>Q 0 Contd</b>			Check engine condition	Refer to specialist
			Check prop shaft condition	Refer to specialist
			Check axle gearing	Refer to specialist
		Q.2 Transmission gear teeth	Check for damage	Replace or rectify
		Q.3 Transmission bearings	Check for damage or wear	Replace
		Q.4 Partial transmission seizure	Visual inspection and check oil	Replace defective items
		Q.5 Clutch pack failure	Visual inspection	Replace parts
		Q.6 Excessive shaft end float	Check actual float	Re-shim correctly
		Q.7 Wrong oil grade	Visual inspection	Drain and replace







Racecourse Road  
Wolverhampton  
England

Publication No

Issue 07/2012